

A CONNECTION THAT LASTS



NORMA® Product Catalogue

Hose fasteners | Pipe and Hose connectors | Retain and Fix solutions



Now including Quick Connectors

Valid from 03/2023



norma-connects.com

A strong connection for our customers

NORMA values strong partnerships and long-lasting connections.

As a customer, you benefit from a huge selection of connection solutions and tailor-made services, making NORMA® the strongest link in your business, production, or maintenance chains. We stand for a connection that lasts.



A partner at your side

We recognize that our success is built on yours. Your NORMA contact person works where YOU are: no call center, no distance. They are responsive to your needs, speak your language, and share a common cultural understanding.



Long-lasting and proven products

As an OEM manufacturer, we meet the highest quality standards and performance requirements at all times. NORMA's "fit and forget" commitment means worry-free installation without subsequent complaints or damage, driving satisfaction for you and your customers.



Universal product portfolio

Thanks to our wide range of products, we are your one-stop shop for every challenge in the field of connection and fastening technology. Our globally renowned NORMA® brand inspires confidence, making sales easier and distinguishing your business from the competition.

Professional solutions for every profession

Whether you are an engineer, a plumber or a mechanic, we can assure you that, as a professional user, you will love our extensive range of connectors and fasteners. Our hose clamps, pipe couplings, fastening elements and plastic hose connectors are technologically advanced and will help you maintain operational integrity and safety even in critical applications. With our leading brand NORMA®, we offer you first-class quality, unmatched reliability and outstanding performance. This is the reason why we have been setting the standards for excellence in advanced joining technology for over seven decades.

NORMA®'s TORRO® is considered the gold standard for the worm-drive hose clamps that are used in many different industries. Nevertheless, the brand encompasses much more than just clamps: Customers all over the world can count on the excellent performance and extraordinary longevity of our couplings, connectors and fluid lines.



No matter what industry you are active in and for which application you need a connection or fastening solution, we have the right product for sure:



General Hardware



Machine Building



Appliances



Chemical Industry



Automotive Aftermarket



Agriculture



Railway Industry



Marine & Shipbuilding



Sanitary & HVAC



Civil Engineering



Irrigation



Pharma & Biotech



FIND MORE INFORMATION:
NORMA-CONNECTS.COM



Easy, faster, better.

NORMA GROUP WEBSHOP

Your webshop benefits at a glance

- ✓ **Real-time product info**
keeps you updated on all products and new releases
- ✓ **Latest info on delivery times**
is made available without request
- ✓ **Individual pricing information**
is always up-to-date and for all products
- ✓ **Order updates**
are sent to you automatically
- ✓ **Shipment tracking for online orders**
by e-mail and in your webshop account

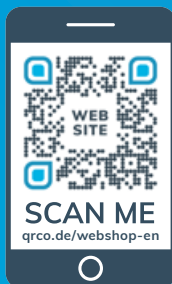

SIMPLY ORDER ONLINE NOW
NORMAGROUP-SHOP.COM





Register now for our online shop.
Exclusive to NORMA customers.

normagroup-shop.com/registration







Materials explanation

- W1** All parts entirely made from galvanized steel
- W2** NORMACLAMP® TORRO®: Band and housing stainless steel AISI 430; Screw: galvanized mild steel
 NORMACLAMP® GBS: Band and housing stainless steel AISI 430; Bolt: galvanized mild steel
 NORMACONNECT® FGR/DCS: see pages 56 and 86
- W2B** Band: stainless steel AISI 430, Screw and housing: galvanized steel
- W3** All parts entirely made from stainless steel AISI 430
- W4** All parts entirely made from stainless steel AISI 304 (or comparable)
- W5** All parts entirely made from stainless steel AISI 316 (or comparable)

Materials International standard designations						
	DIN	AISI/AS	BS	AFNOR NF	SS	SUS
W1	Entirely galvanized steel					
Band and housing						
W2	1.4016	430	430 S 17	Z8 C17	2320	430
Bolt	Galvanized steel					
W3	1.4016	430	430 S 17	Z8 C17	2320	430
W4	1.4301	304	304 S 15	Z6 CN 18-09	2332	304
W5	1.4401	316	316 S 31	Z3 CND 17-11-1	2347	316
Spring insert	1.4310	301	301 S 22	Z12 CN 18-09	2331	301

Bolts

- Sk**  Hexagonal-head bolt
- Sz**  Slotted hexagonal-head bolt
- Zv**  Cylinder-head bolt
- Isk**  Inside hexagonal screw

Pictogram explanation

NORMA® offers different tools, kits, assortments and displays to fit the needs of its customers. The drawings below will help you to know, at a quick glance, if the product is available in another packaging type and/or if it has a special tool.



A tool exists for this product, please refer to the Assortment chapter



This product is available in a kit, please refer to the Assortment chapter



This product is available in an assortment box, please refer to the Assortment chapter



This product is available in display, please refer to the Assortment chapter

Product Family	Product Category	Product Name	Page	
Worm Drive Hose Clamps	Plain Band	TORRO®	16	
		TORRO® WF	19	
		TORRO® TORQUE CAP	21	
		TORRO® THUMBSCREW	21	
		TORRO® TAMPERPROOF	21	
		TORRO® SLOT	22	
		TORRO® PREFIX SYSTEM	22	
		TORRO® WF PREFIX SYSTEM	22	
		TORRO® PREFIX CLIP	23	
		TORRO® PREFIX DOUBLE CLIP	23	
		TORRO® RADIAL INSERT	23	
		TORRO® SAFETY CAP	24	
	HD	25		
		Perforated Band	HI-TORQUE	26
		Quick Lock	QUICK LOCK 9 MM	27
	QUICK LOCK 12 MM		29	
	STRIP STEEL		30	
	QUICK LOCK HOUSING		31	
Heavy Duty Clamps	Trunnion Clamps	GBS M	32	
		GBS STC	34	
		GBS QRC	34	
		GBS MULTI-PARTS	34	
		Profile Band	CC CLAMP	35
Quick Release	Standard	SVS	36	
		SVS P	38	
		SVS EYELET BOLT	38	
Retaining Clamps	Metal	S/SP	39	
		SP SINGLE	43	
		SP DOUBLE	43	
		SPGU	43	
One Piece Clamps	Screwless Clamp	COBRA	44	
	Spring Band Hose Clips	FBS	46	
		FBS R	48	
		FBS C	48	
		FBS HC	48	
		FBS MC	48	
Ear Clips	One Ear Clips	EAR CLIP SINGLE	49	
		EAR CLIP SAFE	50	
		EAR CLIP PRO ³⁶⁰	51	
		CV BOOT CLAMP	52	
		Two Ear Clips	EAR CLIP DOUBLE	53

PLAIN BAND



PERFORATED BAND



QUICK LOCK



TRUNNION CLAMPS



PROFILE BAND



QUICK RELEASE



SCREWLESS CLAMP



SPRING BAND HOSE CLIPS



EAR CLIP PRO³⁶⁰



CV BOOT CLAMP





FGR FLEX



FGR RFP



DCS
UNIVERSAL
CLAW



PLASTIC
COMPRESSION
FITTINGS



EXHAUST PIPE
CLAMP ARS



EXHAUST
PIPE CLAMP
EUROCOUPLER



EXHAUST PIPE
CLAMP M8/M10



EXHAUST PIPE
CLAMP TORCTITE



PROFILE CLAMP
CLAMP V

Product Family	Product Category	Product Name	Page		
Infrastructure Connectors	FGR	FLEX/FLEX E	61		
		FLEX 3	66		
		GRIP/GRIP E	69		
		GRIP E-FP	74		
		RFP	76		
		PLAST GRIP/PLAST GRIP E	77		
		COMBI GRIP E	79		
		COMBI GRIP	80		
		SUPPORT SLEEVE	81		
		REP E	83		
	DCS	RAPID	88		
		RAPID MSM	89		
		UNIVERSAL CLAW	90		
		RECORD CLAW	91		
		COMBI CLAW	92		
		CONFIX	93		
		Compression Fittings	Plastic Compression Fittings	OVERVIEW PRODUCT RANGE	96
MALE THREADED ADAPTOR (MA)	98				
FEMALE THREADED ADAPTOR (FA)	98				
MALE THREADED TEE (MT)	99				
FEMALE THREADED TEE (FT)	99				
MALE THREADED ELBOW - MALE BEND 90 (MB)	100				
FEMALE THREADED ELBOW - FEMALE BEND 90 (FB)	100				
STRAIGHT COUPLER (SC)	101				
EQUAL BEND (EB)	101				
EQUAL TEE (ET)	101				
END CAP (EC)	101				
REDUCING COUPLER (RC)	102				
REDUCING TEE (RT)	102				
FLANGE ADAPTOR (FLA)	102				
POP-UP EQUAL BEND (PE)	103				
WALL PLATE ELBOW (WPE)	103				
MALE THREADED ADAPTOR WITH BRASS INSERT (MAB)	103				
FEMALE THREADED ADAPTOR WITH BRASS INSERT (FAB)	103				
FEMALE THREADED BEND WITH BRASS INSERT (FBB)	103				
Pipe Clamps	Exhaust Pipe Clamp			SEC	104
		ARS	105		
		RS/DIN	107		
		ACCUSEAL	108		
		ACCULOCK	109		
		EUROCOUPLER	110		
		PIPE CLAMP M8/M10	111		
		EASYSEAL	112		
		TORCTITE	113		
		Wide Band Clamp	BRS / BRSP	114	
		Profile Clamps	With Cover Band	V STC/V QRC	115
			Without Cover Band	VPP BRIDGE	120

Product Family	Product Category	Product Name	Page	
Banding Systems	Polyamide Cable Ties	CABLE TIE WHITE	122	
		CABLE TIE BLACK	122	
		CABLE TIE COLORED	122	
		CABLE TIE WITH METAL BARB	124	
	Stainless Steel Cable Ties	STAINLESS STEEL TIE BALL LOCKING	125	
		Endless Band	NORMETTA® SMOOTH BAND	127
			NORMETTA® STAMPED BAND	127
	NORMETTA® PERFORATED BAND		127	
	Buckles	NB-D	128	
		NB-G	128	
		NB-H	129	
		NB-K	129	
	Fixing Clips and Straps	Rubber Clips	RSGU 1	130
			RSGU 0	132
RSGU 2			132	
RSGUV 1			132	
Metal Clips		RS 1	133	
		RS 0	134	
		RS 2	134	
		RSV 1	134	
		HMK	135	
		HMK SINGLE-PART HEAVY DUTY	137	
		HMK TWO-PART HEAVY DUTY	137	
		HMK K1	137	
		REINFORCED PIPE CLAMP / ISOPHONIC PIPE CLAMP	138	
		U-BOLT CLAMP	142	
		BSL	144	
		BSN	148	
		BSS	149	
		BS	150	
Plastic Clips		HVAC CLIP	151	
Mounting Elements		TUBE CLAMP FITTINGS	154	
		TRAFFIC SIGN FIXATION	164	

POLYAMIDE CABLE TIES



STAINLESS STEEL CABLE TIE



ENDLESS BAND

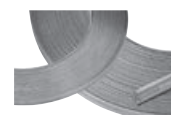

BUCKLES



RUBBER CLIP



METAL CLIPS



METAL CLIPS



HVAC CLIP



TUBE CLAMP FITTINGS



TRAFFIC SIGN FIXATION





HOSE CONNECTORS TES



HOSE CONNECTORS WES



HOSE CONNECTORS GS



HOSE CONNECTORS YN



QUICK CONNECTORS



QUICK CONNECTORS



QUICK CONNECTORS

Product Family	Product Category	Product Name	Page		
Plastic Connectors	Hose Connectors	SV	168		
		GES	170		
		BST	171		
		TES	171		
		WES	172		
		GS	173		
		GRS	173		
		TS	173		
		KS	174		
		TRS	174		
		YRS	174		
		WS	175		
		YS	175		
		GN	175		
		TN	176		
		WN	176		
		YN	176		
		EG	177		
		EWS	177		
		ET	178		
		EW / WV	178		
		VT / VTR	178		
		VG / VGR	178		
			Quick Connectors	NORMAQUICK® S	181
			NEW SECTION	NORMAQUICK® SR SINGLE-LOCK	182
				NORMAQUICK® PS3	183
				NORMAQUICK® V2	184

Product Family	Product Category	Product Name	Page
NORMA® Kits Assortments Displays Tools Accessories	Kits	NORMACLAMP® QUICK LOCK Band-on-roll	186
		NORMA® Fuel Line Repair Kit	186
	Assortments	NORMACLAMP® TORRO® Assortment type 120 pcs	187
		NORMACLAMP® TORRO® WF Assortment	187
		NORMACLAMP® COBRA® Kit type 500k	187
		NORMACLAMP® FBS Assortment	188
		NORMAQUICK® PLAST® Assortment	188
		NORMAPLAST® Assortment type 365 PA 6 and TORRO® W2	189
		NORMACLAMP® TORRO® Dispenser	190
	Display	NORMACLAMP® TORRO® Pallet	190
NORMACLAMP® QUICK LOCK Band-on-roll dispenser		190	
NORMACLAMP® TORRO Prepo Assembly fixture		191	
NORMA® – Mounting tools	Mounting tools	NORMACLAMP® COBRA® Pneumatic pliers	191
		NORMACLAMP® FBS Pneumatic pliers version S	191
		NORMACLAMP® FBS Pneumatic pliers version W	191
		NORMACLAMP® FBS C Multi-release tool	191
		NORMAFIX® CABLE TIE pliers for 2.2 to 4.8 mm	192
		NORMAFIX® CABLE TIE pliers for 4.8 to 7.8 mm	192
		NORMAFIX® CABLE TIE pliers for 3.6 to 13 mm	192
		NORMAFIX® CABLE TIE pliers for 4.7 to 13 mm	192
		NORMAFIX® Pliers for stainless steel ball locking cable ties	192
		NORMAFIX® NORMETTA® Clamping and cutting tool	192
NORMA® – Pliers	Pliers	NORMACLAMP® EAR CLIP pliers	193
		NORMACLAMP® COBRA® Hand-held pliers CHT1	193
		NORMACLAMP® COBRA® Hand-held pliers CHT2	193
		NORMACLAMP® FBS Hand-held pliers Type 1	194
		NORMACLAMP® FBS Hand-held pliers Type 2	194
		NORMAFIX® RSGUV 1 / RSV 1 Handheld pliers	194
NORMA® – Screwdrivers	Screwdrivers	NORMACLAMP® TORRO® Screwdriver SW6, SW7, SW6/7	195
		NORMACLAMP® Tamperproof screwdriver	195
		NORMACLAMP® HI-TORQUE T-screwdriver	195
		NORMAFIX® TUBE CLAMP FITTINGS Hexagonal key	195
NORMA® – Accessories	Accessories	NORMAFIX® TUBE CLAMP FITTINGS Plastic End Cap	196
		NORMAFIX® TUBE CLAMP FITTINGS Spare Screw	196
		NORMAFIX® Lamppost protection tape	196
		NORMAFIX® CABLE TIE Wall plug bases for cable tie	197
		NORMAFIX® CABLE TIE Mounting bases for cable tie	197

KITS



ASSORTMENTS



DISPLAYS



DISPLAYS



ASSEMBLY TOOLS



ASSEMBLY TOOLS



SCREWDRIVERS



PLIERS







SCREWDRIVERS



ACCESSORIES



PRODUCTS AND APPLICATIONS

		Machine building	White goods	Chemical industry	Irrigation systems	Ship manufacturing
NORMACLAMP®		<ul style="list-style-type: none"> • • • • • • • 	<ul style="list-style-type: none"> • • 	<ul style="list-style-type: none"> • • • • • • 	<ul style="list-style-type: none"> • • • • 	<ul style="list-style-type: none"> • • • •
NORMACONNECT®		<ul style="list-style-type: none"> • • • • • 		<ul style="list-style-type: none"> • • 	<ul style="list-style-type: none"> • 	<ul style="list-style-type: none"> •
NORMAFIX®		<ul style="list-style-type: none"> • • • 	<ul style="list-style-type: none"> • 	<ul style="list-style-type: none"> • • • 	<ul style="list-style-type: none"> • • • • 	<ul style="list-style-type: none"> • • •
NORMAPLAST®		<ul style="list-style-type: none"> • 	<ul style="list-style-type: none"> • 	<ul style="list-style-type: none"> • 	<ul style="list-style-type: none"> • 	
NORMAQUICK®		<ul style="list-style-type: none"> • 				

PRODUCTS AND APPLICATIONS

Food and beverage industry	Railway industry	Agricultural machines	Building machines	Engine manufacturing	Pump and filter	Mining industry	Building and site drainage	
•	• • • • •	• • • • •	• • • • •	• • • • •	• • • • •	• • •	•	NORMACLAMP®
• •	•	• • • •	• • • •	• • • • •	• •	•	•	NORMACONNECT®
• • •	• • • •	• • •	• • • •	• • • •	• • • •	• • •	•	NORMAFIX®
•	•	•	•	•	•			NORMAPLAST®
		•	•	•				NORMAQUICK®

NORMACLAMP®
Hose Clamps

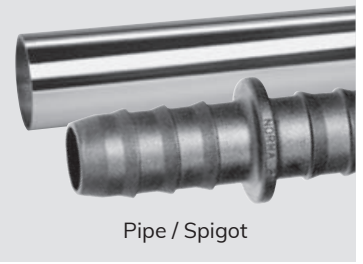
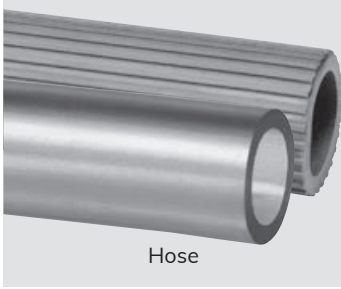

NORMACONNECT®
Pipe Connections

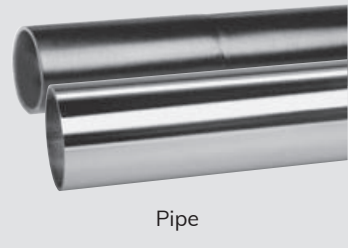

NORMAFIX®
Retaining Products

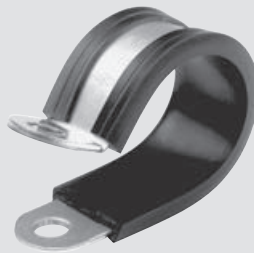

* Can be designed into a complete system in conjunction with NORMAFLEX® smooth and/or corrugated tube.

NORMAPLAST® Hose Connectors**
NORMAQUICK® Quick Connectors

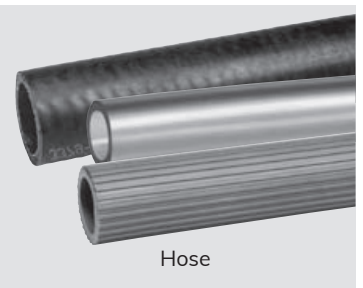
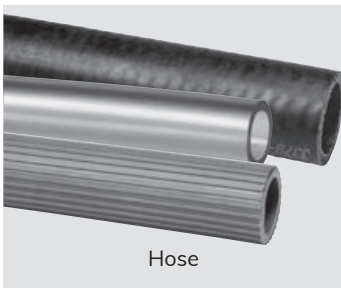

** Several of the NORMACLAMP® products can be used.

NORMACLAMP® – Hose Clamps

A comprehensive range to suit diverse applications

Whether you're looking for static hose clamps without springs or dynamic ones with springs, single-range or multi-range clamps, with NORMACLAMP® you'll find the perfect solution for any application.



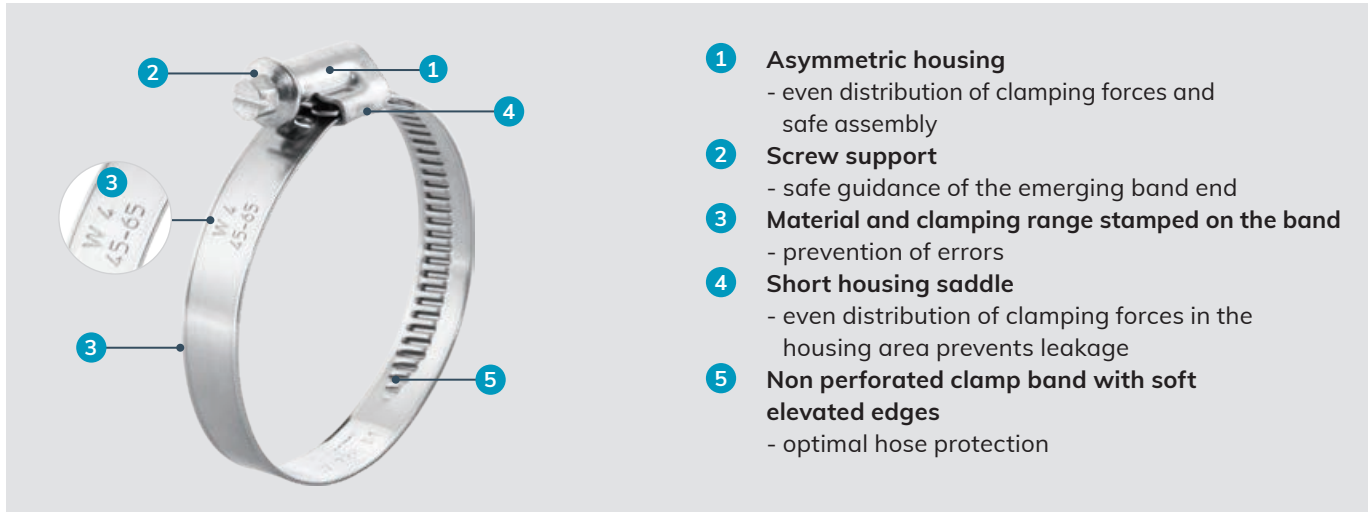

- 1 Asymmetric housing**
- even distribution of clamping forces and safe assembly
- 2 Screw support**
- safe guidance of the emerging band end
- 3 Material and clamping range stamped on the band**
- prevention of errors
- 4 Short housing saddle**
- even distribution of clamping forces in the housing area prevents leakage
- 5 Non perforated clamp band with soft elevated edges**
- optimal hose protection

Worm drive hose clamps in accordance with DIN 3017

NORMACLAMP® TORRO® multi-range hose clamps are ideally suited to applications with high mechanical loads. Thanks to the continuous developments these products have undergone, they remain the benchmark within modern clamp construction. Within the NORMACLAMP® range, only the TORRO® has its trademark asymmetrical construction. The asymmetric housing provides high force, superior torque and even distribution of clamping forces. Clamp aligns perfectly on the hose and ensures the optimal sealing of the connection.



Advantages at a glance

- ✓ Multi-range hose clamp
- ✓ No chromium (VI) used for coating purposes
- ✓ Clamping ranges in acc. with DIN 3017: 8-12 mm to 140-160 mm
- ✓ Larger diameters available on request

Applications

- Joining cooling water lines
- Depressurized and pressurized fuel lines and ventilation systems
- Oil lines
- Joining lines in sanitary applications
- Joining lines in machine building applications
- Lines in the household appliance industry
- Hose lines in the commercial vehicle industries

Materials

W1*	W2	W3	W4	W5
x	x	x	x	x

* No chromium (VI) used for the coating on the closure components

Material	Corrosion resistance in salt spray testing
W1	Min. 144 h
W2	Min. 72 h
W3	Min. 240 h*
W4	Min. 480 h
W5	Min. 1000 h

* Max 10% base metal corrosion permissible

Types of clamp band and screw

		W1	W2	W3	W4	W5
Phillips head	SW 7*	•	•			
Slotted head	SW 7			•	•	•

* Band width 7.5 mm = SW 6

Band width 7.5 mm

- W2, W3 with smooth inside

Band width 9 mm

- W1 with smooth inside
- W2, W3, W4, W5 with stamped inside

Band width 12 mm

- W1, W2, W3 with smooth inside
- W4, W5 with stamped inside

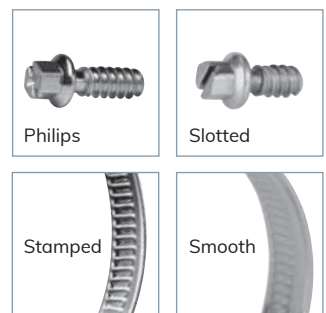

Technical data & Ordering information

NORMACLAMP® TORRO®													
Width	Designation	Clamping ranges		B	h	L	s	s (W1 only)	W1 Product No.	W2 Product No.	W4 Product No.	W5 Product No.	
		in mm	in inches										
7.5	TORRO 8-12/7.5	8-12	5/16-1/2"	11.5	9	17	0.6			0116 7602 010			
	TORRO 10-16/7.5	10-16	3/8-5/8"	11.5	9	17	0.6			0116 7602 013			
	TORRO 12-18/7.5	12-18	1/2-11/16"	11.5	9	17	0.6			0116 7602 015			
	TORRO 12-22/7.5	12-22	1/2-7/8"	11.5	9	17	0.6			0116 7602 017			
	TORRO 16-27/7.5	16-27	5/8-1 1/16"	11.5	9	17	0.6			0116 7602 021			
9	TORRO 8-12/9	8-12	5/16-1/2"	13.0	11.0	21.0	0.65	0.8	0126 7565 010	0126 7702 010	0126 7704 010		
	TORRO 8-16/9	8-16	5/16-5/8"	13.0	11.0	21.0	0.65	0.8		0126 7702 013	0126 7704 013	0126 7705 013	
	TORRO 10-16/9	10-16	5/16-5/8"	13.0	11.0	21.0	0.65	0.8	0126 7565 013				
	TORRO 12-22/9	12-22	1/2-7/8"	13.0	11.0	24.0	0.65	0.8	0126 7565 017	0126 7702 017	0126 7704 017	0126 7705 017	
	TORRO 16-27/9	16-27	5/8-1 1/16"	13.0	11.0	24.0	0.65	0.8	0126 7565 021	0126 7702 021	0126 7704 021	0126 7705 021	
	TORRO 20-32/9	20-32	13/16-1 1/4"	13.0	11.0	24.0	0.65	0.8	0126 7565 026	0126 7702 026	0126 7704 026	0126 7705 026	
	TORRO 25-40/9	25-40	1-1 9/16"	13.0	11.0	26.0	0.65	0.8	0126 7565 032	0126 7702 032	0126 7704 032	0126 7705 032	
	TORRO 30-45/9	30-45	1 3/16-1 3/4"	13.0	11.0	26.0	0.65	0.8	0126 7565 037	0126 7702 037	0126 7704 037	0126 7705 037	
	TORRO 35-50/9 (32-50)	35-50	1 3/8-2"	13.0	11.0	26.0	0.65	0.8	0126 7565 043	0126 7702 041	0126 7704 041	0126 7705 041	
	TORRO 40-60/9	40-60	1 9/16-2 3/8"	13.0	11.0	26.0	0.65	0.8	0126 7565 050	0126 7702 050	0126 7704 050	0126 7705 050	
	TORRO 50-70/9	50-70	2-2 3/4"	13.0	11.0	26.0	0.65	0.8	0126 7565 060	0126 7702 060	0126 7704 060	0126 7705 060	
	TORRO 60-80/9	60-80	2 3/8-3 1/8"	13.0	11.0	26.0	0.65	0.8	0126 7565 070	0126 7702 070	0126 7704 070	0126 7705 070	
	TORRO 70-90/9	70-90	2 3/4-3 9/16"	13.0	11.0	26.0	0.65	0.8	0126 7565 080	0126 7702 080	0126 7704 080	0126 7705 080	
	TORRO 80-100/9	80-100	3 1/8-3 15/16"	13.0	11.0	26.0	0.65	0.8	0126 7565 090	0126 7702 090	0126 7704 090	0126 7705 090	
	TORRO 90-110/9	90-110	3 9/16-4 5/16"	13.0	11.0	26.0	0.65	0.8	0126 7565 100	0126 7702 100	0126 7704 100	0126 7705 100	
	TORRO 100-120/9	100-120	3 15/16-4 3/4"	13.0	11.0	26.0	0.65	0.8	0126 6565 110	0126 6702 110	0126 6704 110	0126 6705 110	
	TORRO 110-130/9	110-130	4 5/16-5 1/8"	13.0	11.0	26.0	0.65	0.8	0126 6565 120	0126 6702 120	0126 6704 120	0126 6705 120	
	TORRO 120-140/9	120-140	4 3/4-5 1/2"	13.0	11.0	26.0	0.65	0.8	0126 6565 130	0126 6702 130	0126 6704 130	0126 6705 130	
	TORRO 130-150/9	130-150	5 1/8-5 15/16"	13.0	11.0	26.0	0.65	0.8	0126 6565 140	0126 6702 140	0126 6704 140	0126 6705 140	
	TORRO 140-160/9	140-160	5 1/2-6 5/16"	13.0	11.0	26.0	0.65	0.8	0126 6565 150	0126 6702 150	0126 6704 150	0126 6705 150	
	TORRO 150-170/9	150-170	5 7/8-6 3/4"	13.0	11.0	26.0	0.65	0.8	0126 6565 160	0126 6702 160	0126 6704 160	0126 6705 160	
	TORRO 160-180/9	160-180	6 1/4-7 1/16"	13.0	11.0	26.0	0.65	0.8	0126 6565 170	0126 6702 170	012 66704 170	0126 6705 170	
	TORRO 170-190/9	170-190	6 3/4-7 1/2"	13.0	11.0	26.0	0.65	0.8	0126 6565 180	0126 6702 180	012 66704 180	0126 6705 180	
	TORRO 180-200/9	180-200	7 1/16-7 7/8"	13.0	11.0	26.0	0.65	0.8	0126 6565 190	0126 6702 190	0126 6704 190	0126 6705 190	
	TORRO 190-210/9	190-210	7 1/2-8 1/4"	13.0	11.0	26.0	0.65	0.8	0126 6565 200	0126 6702 200	0126 6704 200	0126 6705 200	
	12	TORRO 16-27/12	16-27	5/8-1 1/16"	14.6	12.5	30.0	0.8	0.8	0136 7352 021	0136 7702 021	0136 7704 021	0136 7705 021
		TORRO 20-32/12	20-32	13/16-1 1/4"	14.6	12.5	30.0	0.8	0.8	0136 7352 026	0136 7702 026	0136 7704 026	0136 7705 026
		TORRO 25-40/12	25-40	1-1 9/16"	14.6	12.5	30.0	0.8	1.0	0136 7352 032	0136 7702 032	0136 7704 032	0136 7705 032
		TORRO 30-45/12	30-45	1 3/16-1 3/4"	14.6	12.5	30.0	0.8	1.0	0136 7352 037	0136 7702 037	0136 7704 037	0136 7705 037
		TORRO 35-50/12	35-50	1 3/8-2"	14.6	12.5	30.0	0.8	1.0	0136 7352 043	0136 7702 043	0136 7704 043	0136 7705 043
TORRO 40-60/12		40-60	1 9/16-2 3/8"	14.6	12.5	30.0	0.8	1.0	0136 7352 050	0136 7702 050	0136 7704 050	0136 7705 050	
TORRO 50-70/12		50-70	2-2 3/4"	14.6	12.5	30.0	0.8	1.0	0136 7352 060	0136 7702 060	0136 7704 060	0136 7705 060	
TORRO 60-80/12		60-80	2 3/8-3 1/8"	14.6	12.5	30.0	0.8	1.0	0136 7352 070	0136 7702 070	0136 7704 070	0136 7705 070	
TORRO 70-90/12		70-90	2 3/4-3 9/16"	14.6	12.5	36.0	0.8	1.0	0136 7352 080	0136 7702 080	0136 7704 080	0136 7705 080	
TORRO 80-100/12		80-100	3 1/8-3 15/16"	14.6	12.5	36.0	0.8	1.0	0136 7352 090	0136 7702 090	0136 7704 090	0136 7705 090	
TORRO 90-110/12		90-110	3 9/16-4 5/16"	14.6	12.5	36.0	0.8	1.0	0136 7352 100	0136 7702 100	0136 7704 100	0136 7705 100	
TORRO 100-120/12		100-120	3 15/16-4 3/4"	14.6	12.5	36.0	0.8	1.0	0136 6352 110	0136 6702 110	0136 6704 110	0136 6705 110	
TORRO 110-130/12		110-130	4 5/16-5 1/8"	14.6	12.5	36.0	0.8	1.0	0136 6352 120	0136 6702 120	0136 6704 120	0136 6705 120	
TORRO 120-140/12		120-140	4 3/4-5 1/2"	14.6	12.5	36.0	0.8	1.0	0136 6352 130	0136 6702 130	0136 6704 130	0136 6705 130	
TORRO 130-150/12		130-150	5 1/8-5 15/16"	14.6	12.5	36.0	0.8	1.0	0136 6352 140	0136 6702 140	0136 6704 140	0136 6705 140	
TORRO 140-160/12		140-160	5 1/2-6 5/16"	14.6	12.5	36.0	0.8	1.0	0136 6352 150	0136 6702 150	0136 6704 150	0136 6705 150	
TORRO 150-170/12		150-170	5 7/8-6 3/4"	14.5	12.5	36.0	0.8	1.0	0136 6352 160	0136 6702 160	0136 6704 160	0136 6705 160	
TORRO 160-180/12		160-180	6 1/4-7 1/16"	14.5	12.5	36.0	0.8	1.0	0136 6352 170	0136 6702 170	0136 6704 170	0136 6705 170	
TORRO 170-190/12		170-190	6 3/4-7 1/2"	14.5	12.5	36.0	0.8	1.0	0136 6352 180	0136 6702 180	0136 6704 180	0136 6705 180	
TORRO 180-200/12		180-200	7 1/16-7 7/8"	14.5	12.5	36.0	0.8	1.0	0136 6352 190	0136 6702 190	0136 6704 190	0136 6705 190	
TORRO 190-210/12		190-210	7 1/2-8 1/4"	14.5	12.5	36.0	0.8	1.0	0136 6352 200	0136 6702 200	0136 6704 200	0136 6705 200	
TORRO 200-220/12		200-220	7 7/8-8 5/8"	14.5	12.5	36.0	0.8	1.0	0136 6352 210	0136 6702 210	0136 6704 210	0136 6705 210	
TORRO 210-230/12		210-230	8 1/4-9 1/16"	14.5	12.5	36.0	0.8	1.0	0136 6352 220	0136 6702 220	0136 6704 220	0136 6705 220	
TORRO 220-240/12		220-240	8 5/8-9 1/2"	14.5	12.5	36.0	0.8	1.0	0136 6352 230	0136 6702 230	0136 6704 230	0136 6705 230	
TORRO 230-250/12		230-250	9 1/16-9 7/8"	14.5	12.5	36.0	0.8	1.0	0136 6352 240	0136 6702 240	0136 6704 240	0136 6705 240	
TORRO 240-260/12		240-260	9 1/2-10 1/4"	14.5	12.5	36.0	0.8	1.0	0136 6352 250	0136 6702 250	0136 6704 250	0136 6705 250	
TORRO 250-270/12		250-270	9 7/8-10 5/8"	14.5	12.5	36.0	0.8	1.0	0136 6352 260	0136 6702 260	0136 6704 260	0136 6705 260	
TORRO 260-280/12		260-280	10 1/4-11"	14.5	12.5	36.0	0.8	1.0	0136 6352 270	0136 6702 270	0136 6704 270	0136 6705 270	
TORRO 270-290/12		270-290	10 5/8-11 3/8"	14.5	12.5	36.0	0.8	1.0	0136 6352 280	0136 6702 280	0136 6704 280	0136 6705 280	
TORRO 280-300/12		280-300	11-11 7/8"	14.5	12.5	36.0	0.8	1.0	0136 6352 290	0136 6702 290	0136 6704 290	0136 6705 290	

Additional diameters on request (up to 700 mm).
 Our recommendation for bigger diameters:
 Hi-Torque product group. See page 26.
 Available in W3 on request.

Refer to pages 187, 189, 190 and 195

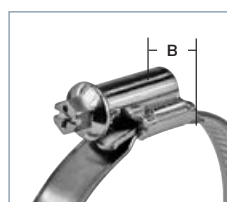

B = overall width housing

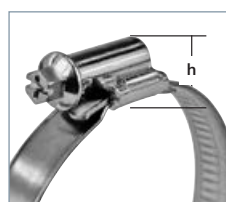

h = overall height bolt and housing

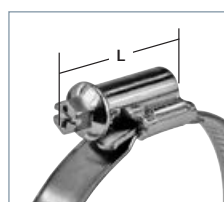

L = overall length bolt and housing

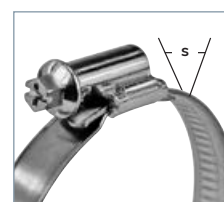

s = band thickness clamp band

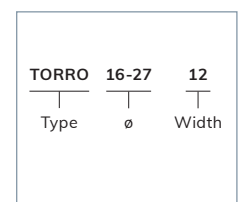

Name structure clamp band

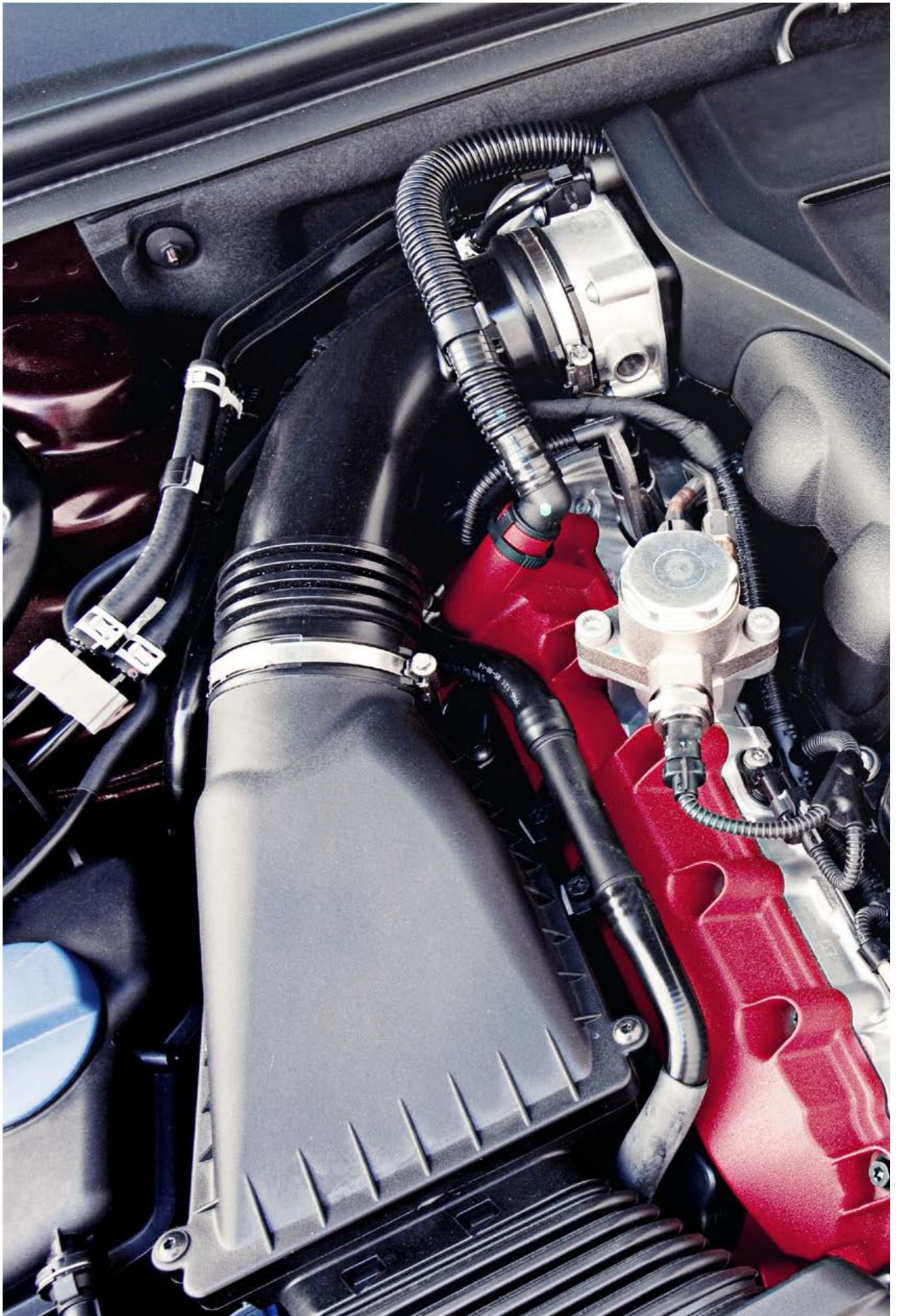



The TORRO® WF clamp is fitted with a wave spring which automatically re-tensions to ensure optimal radial clamping force. The TORRO® WF is the ideal choice for applications under extreme temperature changes (e.g. charged air), under extremely low temperatures or for the retention of hoses with a tendency of “creeping”/hose relaxation.

Advantages at a glance

- Automatic re-tensioning effect in the event of hose relaxation
- Increased sealing reliability across a wide temperature range

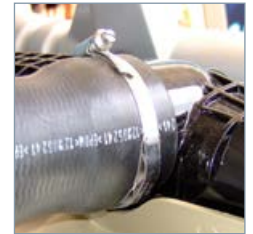

Materials

W3, W4

NORMACLAMP®

NORMACLAMP® TORRO® WF									
Width	Designation	Clamping ranges		B	h	L	s	W3 Product No.	W4 Product No.
		in mm	in inches						
9	TORRO WF 10-16/9	10-16	3/8 - 5/8"	13.0	11.0	21.0	0.65	0127 7708 013	0127 7711 013
	TORRO WF 12-18/9	12-18	1/2-11/16"	13.0	11.0	24.0	0.65	0127 7708 018	0127 7711 015
	TORRO WF 12-20/9	12-20	1/2-13/16"	13.0	11.0	24.0	0.65	0127 7708 016	0127 7711 016
	TORRO WF 12-22/9	12-22	1/2-7/8"	13.0	11.0	24.0	0.65	0127 7708 017	0127 7711 017
	TORRO WF 16-25/9	16-25	5/8-1"	13.0	11.0	24.0	0.65	0127 7708 020	0127 7711 020
	TORRO WF 16-27/9	16-27	5/8-1 1/16"	13.0	11.0	24.0	0.65	0127 7708 021	0127 7711 021
	TORRO WF 20-32/9	20-32	13/16-1 1/4"	13.0	11.0	24.0	0.65	0127 7708 026	0127 7711 026
	TORRO WF 23-35/9	23-35	15/16-1 3/8"	13.0	11.0	24.0	0.65	0127 7708 029	0127 7711 029
	TORRO WF 25-40/9	25-40	1-1 9/16"	13.0	11.0	26.0	0.65	0127 7708 032	0127 7711 032
	TORRO WF 30-45/9	30-45	1 3/16-1 3/4"	13.0	11.0	26.0	0.65	0127 7708 037	0127 7711 037
	TORRO WF 32-50/9	32-50	1 3/8-2"	13.0	11.0	26.0	0.65	0127 7708 041	0127 7711 041
	TORRO WF 40-60/9	40-60	1 9/16-2 3/8"	13.0	11.0	26.0	0.65	0127 7708 050	0127 7711 050
	TORRO WF 45-65/9	45-65	1 3/4-2 9/16"	13.0	11.0	26.0	0.65	0127 7708 055	0127 7711 055
	TORRO WF 50-70/9	50-70	2-2 3/4"	13.0	11.0	26.0	0.65	0127 7708 060	0127 7711 060
	TORRO WF 60-80/9	60-80	2 3/8-3 1/8"	13.0	11.0	26.0	0.65	0127 7708 070	0127 7711 070
	TORRO WF 70-90/9	70-90	2 3/4-3 9/16"	13.0	11.0	26.0	0.65	0127 7708 080	0127 7711 080
	TORRO WF 80-100/9	80-100	3 1/8-3 15/16"	13.0	11.0	26.0	0.65	0127 7708 090	0127 7711 090
	12	TORRO WF 90-110/9	90-110	3 9/16-4 5/16"	13.0	11.0	26.0	0.65	0127 7708 100
TORRO WF 100-120/9		100-120	3 15/16-4 3/4"	13.0	11.0	26.0	0.65	0127 7708 110	0127 7711 110
TORRO WF 110-130/9		110-130	4 3/8-5 1/8"	13.0	11.0	26.0	0.65	0127 7708 120	0127 7711 120
TORRO WF 16-27/12		16-27	5/8-1 1/16"	14.6	12.5	30.0	0.8	0137 7708 021	0137 7711 021
TORRO WF 20-32/12		20-32	13/16-1 1/4"	14.6	12.5	30.0	0.8	0137 7708 026	0137 7711 026
TORRO WF 25-40/12		25-40	1-1 9/16"	14.6	12.5	30.0	0.8	0137 7708 032	0137 7711 032
TORRO WF 30-45/12		30-45	1 3/16-1 3/4"	14.6	12.5	30.0	0.8	0137 7708 037	0137 7711 037
TORRO WF 35-50/12		35-50	1 3/8-2"	14.6	12.5	30.0	0.8	0137 7708 043	0137 7711 043
TORRO WF 40-60/12		40-60	1 9/16-2 3/8"	14.6	12.5	30.0	0.8	0137 7708 050	0137 7711 050
TORRO WF 50-70/12		50-70	2-2 3/4"	14.6	12.5	30.0	0.8	0137 7708 060	0137 7711 060
TORRO WF 60-80/12		60-80	2 3/8-3 1/8"	14.6	12.5	30.0	0.8	0137 7708 070	0137 7711 070
TORRO WF 70-90/12	70-90	2 3/4-3 9/16"	14.6	12.5	36.0	0.8	0137 7708 080	0137 7711 080	
TORRO WF 80-100/12	80-100	3 1/8-3 15/16"	14.6	12.5	36.0	0.8	0137 7708 090	0137 7711 090	
TORRO WF 90-110/12	90-110	3 9/16-4 5/16"	14.6	12.5	36.0	0.8	0137 7708 100	0137 7711 100	

Available in W2 on request

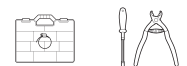

Refer to pages 187 and 195

Table of torques

NORMACLAMP® TORRO®				
Band width (mm)	Material	Diameters	TT	FRT
7.5	W2, W3	all diameters	1.5	-
9	W1	8-12 mm	2.5+0.5	1.2
		all other diameters	3+0.5	1.2
	W2	10-16 mm	2+0.5	0.7
		all other diameters	3+0.5	0.7
	W3, W4, W5	10-16 mm	2+0.5	0.7
		all other diameters	3+0.5	0.7
12	W1	all diameters	5+0.5	1.2
	W2, W3	all diameters	5+0.5	1
	W4, W5	all diameters	5+0.5	1

TT = Tightening Torque
 FRT = Free Running Torque

NORMACLAMP® TORRO® with torque cap

The torque cap shears off when the permissible tightening torque is reached, thus saving the need to use a torque wrench. The bolt slot can still be accessed even after the break-off point, meaning that the clamp can be removed and/or re-tensioned if necessary. Available in 9 and 12 mm band widths on request.

Advantages at a glance

- Defined tightening torque without the need for special tools
- Installation can be checked visually

Materials

W1, W2, W3, W4



Refer to page 195

NORMACLAMP® TORRO® Thumb screw

The NORMACLAMP® TORRO® Thumb screw can be comfortably tightened by hand using the wide screw head. Available in 9 and 12 mm band widths on request.

Main advantage

The clamp can be tightened or opened manually

Materials

W1, W2, W3, W4, W5



Refer to page 195

NORMACLAMP® TORRO® Tamperproof

The NORMACLAMP® TORRO® Tamperproof can only be mounted and dismantled by using the Tamperproof Screwdriver – details on page 199. The specially designed screw head has three radial grooves, which means it cannot be adjusted with any commercially available tools. Automated assembly using a torque gun is particularly effective, as the special shape of the screw head allows for minimal misalignment or offset. Available in 9 and 12 mm band widths on request.

Main advantage

Non-dismountable clamps protect against manipulation

Material

W3, W4



Refer to page 195

Slot



The slot is a clever means of pre-positioning the TORRO® hose clip on the hose. In this case the oval hole in the clamp band finds its exact counterpart on the hose surface. Thus the TORRO® is safely and accurately kept in place prior to the final assembly. Available in band widths of 9 and 12 mm and different angles on request.

Main advantage

- Safe pre-assembly on rubber sleeves and molded pipes

Material

W3



Refer to page 195

Prefix system



The NORMACLAMP® TORRO® Prefix system is a concept for integrated clamps and clips on hoses and pipes. Demand for complete systems that include the appropriate sealing function is increasing. This system can only be fixed by using a special tool. Available in band widths of 9 and 12 mm on request.

Advantages at a glance

- Safe pre-assembly on hoses and molded pipes
- Two versions, left- and right-handed. Works on silicone and rubber hoses

Materials

W3, W4



Refer to page 191

WF Prefix system



The NORMACLAMP® TORRO® WF Prefix system is the combination of the NORMACLAMP® TORRO® WF and the NORMACLAMP® Prefix system. This system can only be fixed by using a special tool. Available in 9 and 12 mm band widths on request.

Advantages at a glance

- Axial and radial adjustment of the clamp
- Possible for multilayer hoses and blow molded pipes
- Already available in series for different hose thickness
- Clinch design
- Two versions, left- and right-handed
- Works on silicone and rubber hoses

Materials

W3, W4



Refer to page 191

Prefix clip



With this feature the TORRO® can also be pre-positioned on the hose. The two 'teeth' of this device keep the TORRO® hose clip safely in place if it needs to be stocked or transported prior to its final assembly. Available in band widths of 9 and 12 mm on request.

Advantages at a glance

- Safe pre-assembly on the hose
- Two versions, left- and right-handed

Materials

W3, W4



Refer to page 195

Prefix Double clip



With this feature the TORRO® can also be pre-positioned on the hose. The 'teeth' of the clips keep the TORRO® hose clip safely in place if it needs to be stocked or transported prior to its final assembly. Available for the TORRO® with band width 12 mm.

Advantages at a glance

- Safe pre-assembly on the hose
- Two versions, left- and right-handed

Materials

W3, W4



Refer to page 195

Radial insert



Compared to standard worm drive hose clamps, the Radial Insert is a "Spring Clamp", which offers optimal contraction and expansion capabilities. It is suitable for all applications where the hose is exposed to temperature fluctuations. The special design ensures a reliable seal throughout the complete thermal cycle. Available for the TORRO® with band width 9 mm.

Advantages at a glance

- The internal sliding sleeve optimizes clamping pressure
- High contact pressure due to the radially corrugated design
- Compensates for temperature fluctuations

Material

W1



Refer to page 195

Safety cap



The NORMACLAMP® TORRO® safety cap is a small plastic cap which covers the end of the clamp band, thus stopping injuries from occurring and making a significant contribution to accident prevention measures.

Main advantage

Available band widths

7.5 mm	–	0045 8000 021
9 mm	–	0045 8000 022
12 mm	–	0045 8000 023

Material

PVC

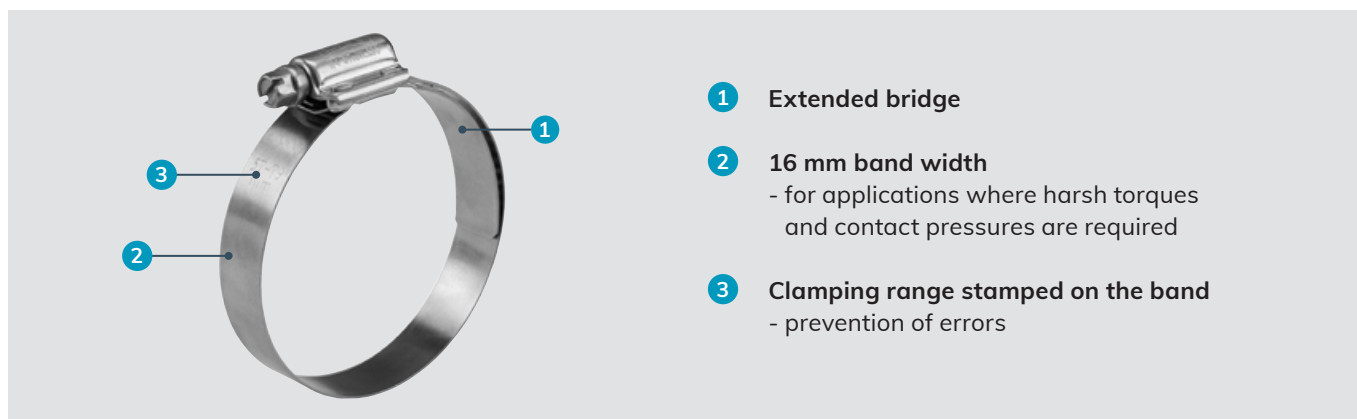

- 1 Extended bridge
- 2 16 mm band width
- for applications where harsh torques and contact pressures are required
- 3 Clamping range stamped on the band
- prevention of errors

Worm drive hose clamps

NORMACLAMP® HD is suitable for special applications where harsh torques and contact pressures are required. This clamp is an add-on type to our range of worm drive hose clips and therefore only available in 16 mm band width and W4 material quality.

Main advantage

- ✓ The extended bridge prevents leaks and hose being damaged

Applications

- Mounting of silicone, plastic and rubber tubing with steel inserts

Materials

Material	Corrosion resistance in salt spray testing
W4	Min. 240 h*

* Max 5% corrosion of the base material allowed

Torques

Band width	Failure torque (min. value)	Recommended tightening torque
16	17 Nm	max. 10 Nm*

* Depending on the type of application

Technical data & Ordering information

NORMACLAMP® HD								
Width	Designation	Clamping ranges		B	h	L	s	W4 Product No.
		in mm	in inches					
16	HD 25-45/16 C8	25-45	1-1 3/4"	23.0	13.0	37.0	0.7	0156 7804 035
	HD 32-54/16 C8	32-54	1 1/4-2 1/8"	23.0	13.0	37.0	0.7	0156 7804 043
	HD 45-67/16 C8	45-67	1 3/4-2 5/8"	23.0	13.0	37.0	0.7	0156 7804 056
	HD 57-79/16 C8	57-79	2 1/4-3 1/8"	23.0	13.0	37.0	0.7	0156 7804 068
	HD 70-92/16 C8	70-92	2 3/4-3 5/8"	23.0	13.0	37.0	0.7	0156 7804 081
	HD 83-105/16 C8	83-105	3 1/4-4 1/8"	23.0	13.0	37.0	0.7	0156 7804 094
	HD 95-118/16 C8	95-118	3 3/4-4 5/8"	23.0	13.0	37.0	0.7	0156 7804 106
	HD 108-130/16 C8	108-130	4 1/4-5 1/8"	23.0	13.0	37.0	0.7	0156 7804 119
	HD 121-143/16 C8	121-143	4 3/4-5 5/8"	23.0	13.0	37.0	0.7	0156 7804 132
	HD 133-156/16 C8	133-156	5 1/4-6 1/8"	23.0	13.0	37.0	0.7	0156 7804 144
	HD 146-168/16 C8	146-168	5 3/4-6 5/8"	23.0	13.0	37.0	0.7	0156 7804 157
	HD 159-181/16 C8	159-181	6 1/4-7 1/8"	23.0	13.0	37.0	0.7	0156 7804 170
	HD 172-194/16 C8	172-194	6 3/4-7 5/8"	23.0	13.0	37.0	0.7	0156 7804 183
	HD 184-206/16 C8	184-206	7 1/4-8 1/8"	23.0	13.0	37.0	0.7	0156 7804 195
	HD 197-219/16 C8	197-219	7 3/4-8 5/8"	23.0	13.0	37.0	0.7	0156 7804 208
	HD 210-232/16 C8	210-232	8 1/4-9 1/8"	23.0	13.0	37.0	0.7	0156 7804 221

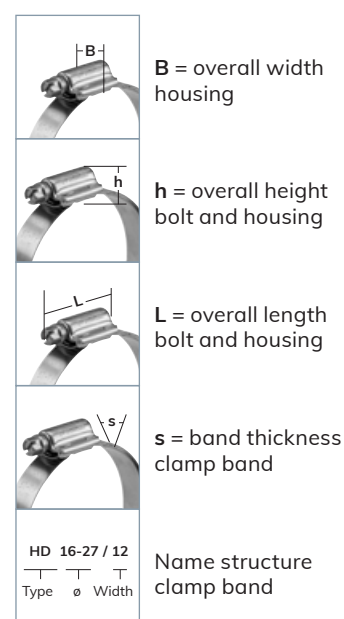

Other sizes available on request

Refer to page 195



HI-TORQUE CLAMP

NORMACLAMP®

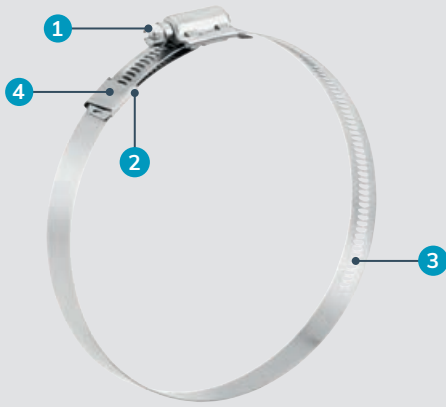

- 1 Screw housing for easy tightening
- 2 'In-line' housing, which enables every thread on the worm to engage with the band
- 3 Perforated band
- 4 Safety buckle, keeping the band aligned

Signage clamp

The NORMACLAMP® Hi-Torque Signage Clamp is produced using components entirely manufactured from stainless steel. The construction of the worm-drive housing on the band facilitates installation of a wide range of signs. Hi-Torque clamps are reusable and easy to retighten after

expansion caused by temperature fluctuations, and their construction ensures that during installation there are no sharp edges which might cause injury to the installer. The recommended tightening torque for secure and reliable installation is 16 Nm and the breaking torque is more than 20 Nm.

Advantages at a glance

- ✓ Reusable
- ✓ Secure and reliable installation
- ✓ Easy to retighten in cases of expansion (due to temperature fluctuations)
- ✓ No loss of material when installing
- ✓ Easy installation of two signs on one pole

Applications

- Traffic signs, street signs, billboards and illuminated signs installation
- Heavy duty sealing applications
- Agricultural
- Chemical Industry
- Food Processing
- Fluid Transfer
- Marine Industry
- Petrochemical Industry
- Shipyards

Materials

W1	W2	W3	W4	W5
			x	

Technical data & Ordering information

NORMACLAMP® HI-TORQUE				
Width	Designation	Clamping ranges		W4 Product No.
		in mm	in inches	
16	HI-TORQUE 32-67/16	32-67	1 1/4-2 5/8"	0560 6610 050
	HI-TORQUE 54-105/16	54-105	2 1/8-4 1/8"	0560 6610 080
	HI-TORQUE 102-156/16	102-156	4-6 1/8"	0560 6610 129
	HI-TORQUE 156-232/16	156-232	6 1/8-9 1/8"	0560 6610 194
	HI-TORQUE 229-384/16	229-384	9-15 1/8"	0560 6610 307



Refer to page 195

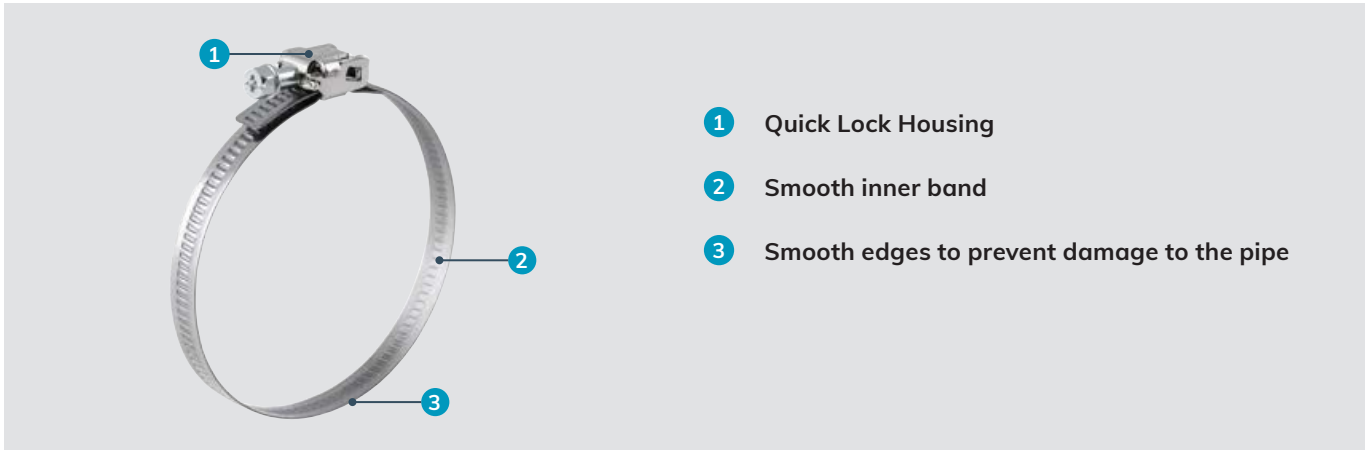

- 1 Quick Lock Housing
- 2 Smooth inner band
- 3 Smooth edges to prevent damage to the pipe

Quick locking clamp

NORMACLAMP® Quick Lock 9 mm is manufactured from a continuously threaded band with smooth edges to prevent damage to the pipe. The Quick Lock housing allows easy

and quick application, as the band can be adjusted to the right diameter of the pipe, before securing the lock with the screw. Band thickness 0.6 mm for band width 9 mm.

Advantages at a glance

- ✓ Easy and quick application
- ✓ Safe joint with the hose
- ✓ Flexibility
- ✓ Clamping range from 25-40 up to 60-1300 mm

Applications

- Water industry
- Air conditioning
- Construction
- Sanitary

Materials

W1	W2 (B)*	W3	W4	W5
	x		x	

* W2 (B): Band in stainless steel (W3)
 Screw and housing in galvanized steel (W1)
 W2 (B) is a combination of W1 and W3 materials

Torques

Band width	Tightening torque	Tightening speed
9	2.5+0.5 Nm	Max. 50 RPM

Technical data & Ordering information

NORMACLAMP®

NORMACLAMP® QUICK LOCK 9 MM					
Width	Designation	Clamping ranges		W2 (B) Product No.	W4 Product No.
		in mm	in inches		
9	QUICK LOCK 25-45/9	25-45	1-1 3/4"	0815 6120 045	
	QUICK LOCK 40-60/9	40-60	1 9/16-2 3/8"	0815 6120 060	
	QUICK LOCK 60-90/9	60-90	2 3/8-3 9/16"	0815 6120 090	
	QUICK LOCK 60-110/9	60-110	2 3/8-4 5/16"	0815 6120 110	0815 6130 110
	QUICK LOCK 60-135/9	60-135	2 3/8-5 5/16"	0815 6120 135	0815 6130 135
	QUICK LOCK 60-145/9	60-145	2 3/8-5 11/16"	0815 6120 145	0815 6130 145
	QUICK LOCK 60-170/9	60-170	2 3/8-6 11/16"		0815 6130 170
	QUICK LOCK 60-175/9	60-175	2 3/8-6 7/8"	0815 6120 175	
	QUICK LOCK 60-215/9	60-215	2 3/8-8 7/16"	0815 6120 215	0815 6130 215
	QUICK LOCK 60-270/9	60-270	2 3/8-10 5/8"	0815 6120 270	0815 6130 270
	QUICK LOCK 60-325/9	60-325	2 3/8-12 13/16"	0815 6120 325	0815 6130 325
	QUICK LOCK 60-380/9	60-380	2 3/8- 14 15/16"	0815 6120 380	0815 6130 380
	QUICK LOCK 60-425/9	60-425	2 3/8-16 3/4"	0815 6120 425	0815 6130 425
	QUICK LOCK 60-525/9	60-525	2 3/8-20 11/16"	0815 6120 525	0815 6130 525
	QUICK LOCK 60-660/9	60-660	2 3/8-26"	0815 6120 660	0815 6130 660

Additional diameters available on request



Refer to page 186 and 190

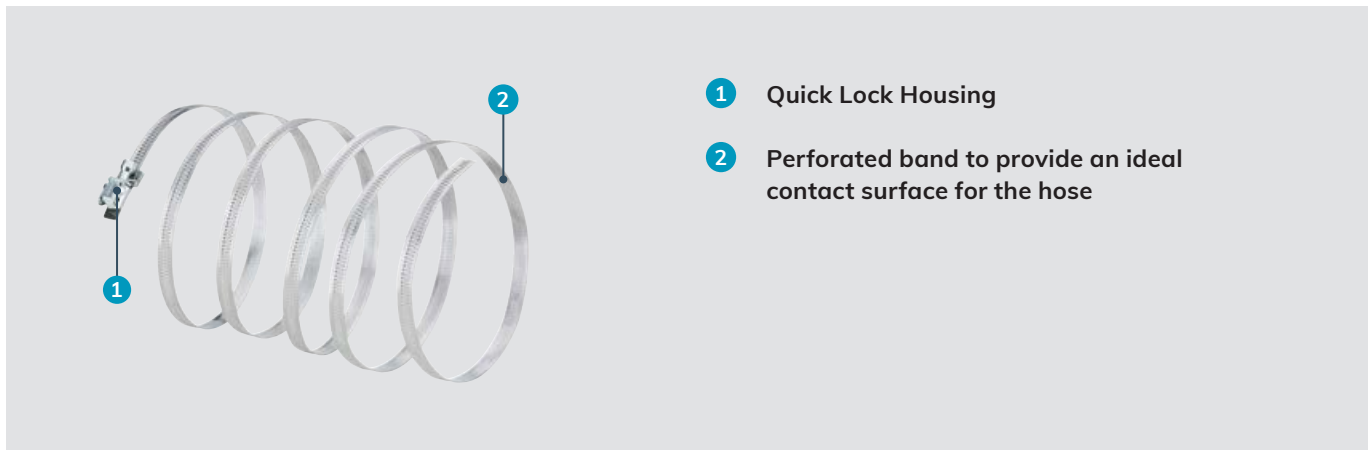

- 1 Quick Lock Housing
- 2 Perforated band to provide an ideal contact surface for the hose

The clamp for large hoses

NORMACLAMP® Quick Lock 12 mm is designed for quick-lock tightening and releasing of large diameter hoses and supplied in a perforated band, to provide an ideal contact surface for the hose. This clamp is the ideal solution for larger hose diameters over 100 mm. Band thickness 0.7 mm for band width 12 mm assures a very flexible clamp.

Advantages at a glance

- ✓ The quick-lock housing eases the assembly of the clamp
- ✓ Safe joint with the hose
- ✓ Flexibility
- ✓ Wide clamping range

Applications

- Water industry
- Air conditioning
- Construction
- Sanitary

Materials

W1	W2 (B)*	W3	W4	W5
	x			

* W2 (B): Band in stainless steel (W3)
 Screw and housing in galvanized steel (W1)
 W2 (B) is a combination of W1 and W3 materials

Technical data & Ordering information

NORMACLAMP® QUICK LOCK 12 MM				
Width	Designation	Clamping ranges		W2 (B) Product No.
		in mm	in inches	
12	QUICK LOCK 50-110/12	50-110	2-4 5/16"	0815 6020 080
	QUICK LOCK 50-130/12	50-130	2-5 1/8"	0815 6020 090
	QUICK LOCK 50-145/12	50-145	2-5 11/16"	0815 6020 098
	QUICK LOCK 50-165/12	50-165	2-6 1/2"	0815 6020 108
	QUICK LOCK 50-175/12	50-175	2-6 7/8"	0815 6020 113
	QUICK LOCK 50-215/12	50-215	2-8 7/16"	0815 6020 133
	QUICK LOCK 50-280/12	50-280	2-11"	0815 6020 165
	QUICK LOCK 50-325/12	50-325	2-12 13/16"	0815 6020 188
	QUICK LOCK 50-370/12	50-370	2-14 9/16"	0815 6020 210
	QUICK LOCK 50-425/12	50-425	2-16 3/4"	0815 6020 238
	QUICK LOCK 60-525/12	60-525	2-20 11/16"	0815 6020 293
	QUICK LOCK 70-625/12	70-625	2-24 5/8"	0815 6020 348



Refer to page 186

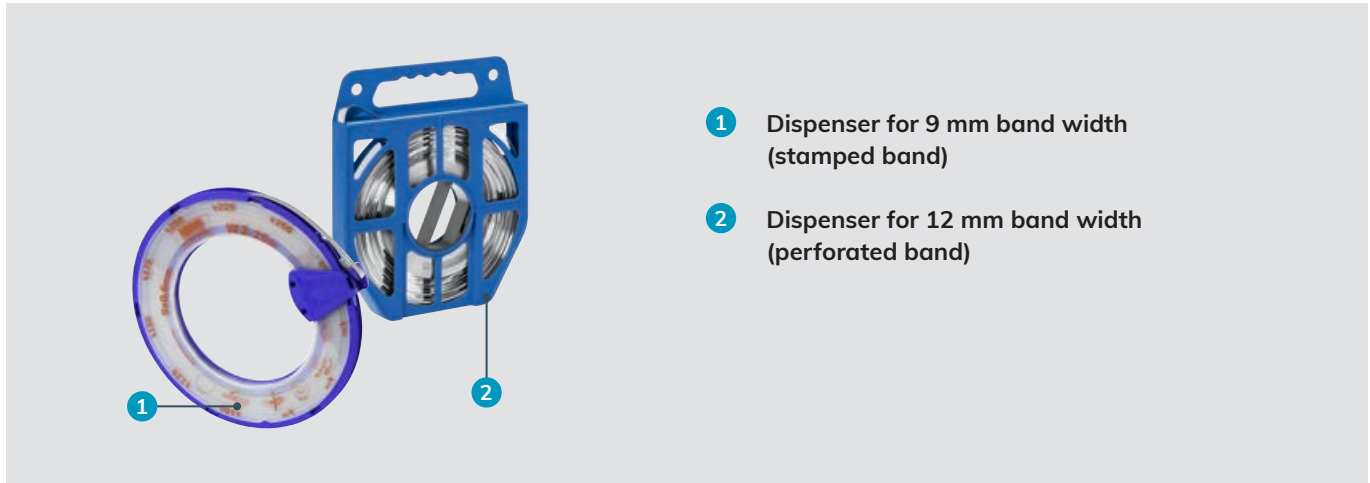

- 1 Dispenser for 9 mm band width (stamped band)
- 2 Dispenser for 12 mm band width (perforated band)

Continuous band for multiple clamp diameters

The NORMACLAMP® Strip Steel is a perfect solution for creating clamps with different diameters depending on a user's needs. Strip Steel is a long continuous band available in 9 or 12 mm band width. For closing the clamp use the NORMACLAMP® Quick Lock Housings in 9 or 12 mm.

Advantages at a glance

- ✓ Variability
- ✓ Flexibility
- ✓ Storage and inventory benefit
- ✓ Allows making up to 44 clamps

Applications

- Water industry
- Air conditioning
- Construction
- Sanitary

Materials

W1	W2 (B)*	W3	W4	W5
	x		x	

* W2 (B): Band in stainless steel (W3)
 Screw and housing in galvanized steel (W1)
 W2 (B) is a combination of W1 and W3 materials

Technical data & Ordering information

NORMACLAMP® STRIP STEEL					
Width	Designation	Length		W2 (B) Product No.	W4 Product No.
		in m	in inch		
9	STRIP STEEL 9 30 MTS	30	118 1/8	0815 7121 008	0815 7131 008
12	STRIP STEEL 12 25 MTS	25	98 7/16	0815 0007 006	

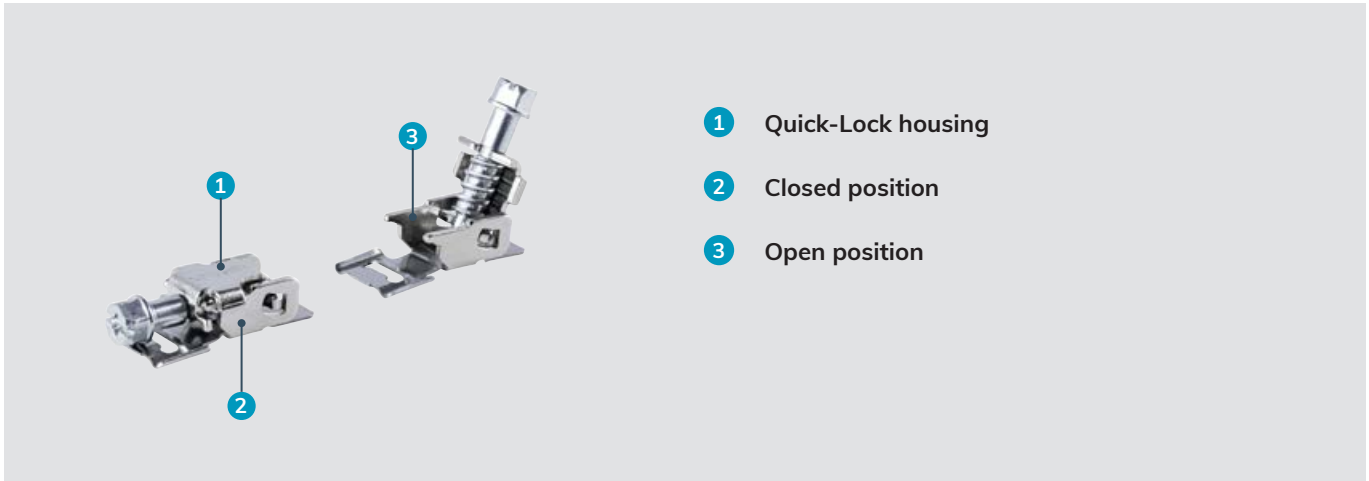

- 1 Quick-Lock housing
- 2 Closed position
- 3 Open position

Locking system for continuous band

The NORMACLAMP® Quick Lock Housings in 9 and 12 mm are used to close the NORMACLAMP® Strip Steel.

Advantages at a glance

- ✓ Fast, simple and safe assembly
- ✓ Enables the closing of clamps of many diameters

Applications

- Water industry
- Air conditioning
- Construction
- Sanitary

Materials

W1	W2 (B)*	W3	W4	W5
	x		x	

* W2 (B): Band in stainless steel (W3)
 Screw and housing in galvanized steel (W1)
 W2 (B) is a combination of W1 and W3 materials

Technical data & Ordering information

NORMACLAMP® QUICK LOCK HOUSING			
Width	Designation	W2 (B) Product No.	W4 Product No.
9	QUICK LOCK HOUSING 9	0815 7121 007	0815 7131 007
12	QUICK LOCK HOUSING 12	0815 6007 008	



- 1 Bolt**
- New specially designed bolt with integrated spacer and improved performance. The W5 version has a socket head cap bolt.
- 2 Reinforced band loops**
- ability to withstand much higher torques
- 3 Mechanically locked closure**
- no welding spots and no contact corrosion
- 4 Bridge**
- hose protection
- 5 Robust band with rounded edges**
- prevents injuries and damage to hoses
- 6 Hollow trunnions**
- reduces the tensile forces on the bolt and the mechanical lock

Heavy-duty clamps for multiple applications

NORMACLAMP® GBS M is designed primarily for use in applications where hose clamps must meet stringent requirements. In particular if suction and pressure hoses – complete with plastic or steel inserts and high shore hardness values – are to be connected and attached. They are particularly suitable for use on commercial and special vehicles. NORMACLAMP® GBS M clamps' ability to withstand exceptionally high levels of band tensile force is an outstanding feature. They are also extremely easy to install, whether you're using manual, pneumatic or electrical standard tools.



Advantages at a glance

- ✓ Failure torques improved by a factor of two
- ✓ Band tensile force levels improved by a factor of three

Applications

- Machine building
- Chemical industry
- Irrigation systems
- Ship manufacturing
- Railway industry
- Agricultural machines
- Building machines
- Engine manufacturing
- Pump and filter
- Mining Industry

Materials

W1	W2	W3	W4	W5
x	x		x	x

Material	Corrosion resistance in salt spray testing
W1	Min. 72 h
W2	Min. 72 h
W4	Min. 240 h
W5	Min. 400 h

NORMACLAMP® GBS M						
Band width	Material thickness in mm					
	W1	W2	W4	W5	M	SW
18	0.8	0.6	0.6	0.6	6	8
20	1.0	0.8	0.8	0.8	7	10
25	1.0	1.0	1.0	1.0	8	13
30	1.3	1.0	1.0	1.0	10	17

Band tensile force

Numerous test results underline the technical superiority of NORMACLAMP® GBS M products over their competitors':

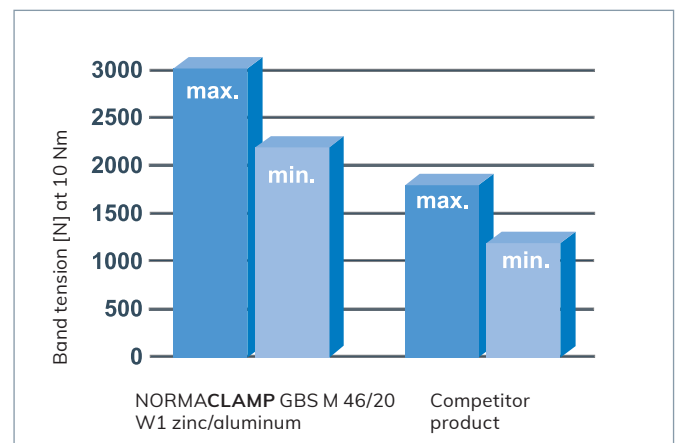

Table of torques

NORMACLAMP® GBS M					
Band width	Failure torque (minimum) Nm				Recommended tightening torque Nm
	W1	W2	W4	W5	
18	15	15	15	15	8
20	25	20	20	20	10
25	35	30	30	30	20
30	50	45	45	45	25

NORMACLAMP® GBS M RUBBER INSERT			
Band width	Failure torque (minimum) Nm		Recommended tightening torque Nm
	W1	W2	
18	10	10	6
20	15	15	8
25	25	25	18
30	40	40	22

Please note: the recommended tightening speed should not exceed 250 rpm

Technical data & Ordering information

NORMACLAMP® GBS M HOLLOW TRUNNION							
Width	Designation	Clamping ranges		W1 Product No.	W2 Product No.	W4 Product No.	W5** Product No.
		in mm	in inches				
18	GBS M 17-19/18 Sk*	17-19	11/16-3/4"	0591 7181 018	0591 7182 018	0591 7184 018	0591 7185 018
	GBS M 19-21/18 Sk*	19-21	3/4-13/16"	0591 7181 020	0591 7182 020	0591 7184 020	0591 7185 020
	GBS M 21-23/18 Sk*	21-23	13/16-15/16"	0591 7181 022	0591 7182 022	0591 7184 022	0591 7185 022
	GBS M 23-25/18 Sk*	23-25	15/16-1"	0591 7181 024	0591 7182 024	0591 7184 024	0591 7185 024
	GBS M 25-27/18 Sk	25-27	1-1 1/16"	0591 7181 026	0591 7182 026	0591 7184 026	0591 7185 026
	GBS M 27-29/18 Sk	27-29	1 1/16-1 1/8"	0591 7181 028	0591 7182 028	0591 7184 028	0591 7185 028
	GBS M 29-31/18 Sk	29-31	1 1/8-1 1/4"	0591 7181 030	0591 7182 030	0591 7184 030	0591 7185 030
	GBS M 31-34/18 Sk	31-34	1 1/4-1 5/16"	0591 7181 033	0591 7182 033	0591 7184 033	0591 7185 033
	GBS M 34-37/18 Sk	34-37	1 5/16-1 7/16"	0591 7181 036	0591 7182 036	0591 7184 036	0591 7185 036
	GBS M 37-40/18 Sk	37-40	1 7/16-1 9/16"	0591 7181 039	0591 7182 039	0591 7184 039	0591 7185 039
20	GBS M 40-43/18 Sk	40-43	1 9/16-1 11/16"	0591 7181 042	0591 7182 042	0591 7184 042	0591 7185 042
	GBS M 43-47/20 Sk	43-47	1 11/16-1 7/8"	0591 7201 045	0591 7202 045	0591 7204 045	0591 7205 045
	GBS M 47-51/20 Sk	47-51	1 7/8-2"	0591 7201 049	0591 7202 049	0591 7204 049	0591 7205 049
	GBS M 51-55/20 Sk	51-55	2-2 3/16"	0591 7201 053	0591 7202 053	0591 7204 053	0591 7205 053
	GBS M 55-59/20 Sk	55-59	2 3/16-2 5/16"	0591 7201 057	0591 7202 057	0591 7204 057	0591 7205 057
	GBS M 59-63/20 Sk	59-63	2 5/16-2 1/2"	0591 7201 061	0591 7202 061	0591 7204 061	0591 7205 061
25	GBS M 63-68/20 Sk	63-68	2 1/2-2 11/16"	0591 7201 066	0591 7202 066	0591 7204 066	0591 7205 066
	GBS M 68-73/25 Sk	68-73	2 11/16-2 7/8"	0591 7251 071	0591 7252 071	0591 7254 071	0591 7255 071
	GBS M 73-79/25 Sk	73-79	2 7/8-3 1/8"	0591 7251 076	0591 7252 076	0591 7254 076	0591 7255 076
	GBS M 79-85/25 Sk	79-85	3 1/8-3 3/8"	0591 7251 082	0591 7252 082	0591 7254 082	0591 7255 082
	GBS M 85-91/25 Sk	85-91	3 3/8-3 9/16"	0591 7251 088	0591 7252 088	0591 7254 088	0591 7255 088
	GBS M 91-97/25 Sk	91-97	3 9/16-3 13/16"	0591 7251 094	0591 7252 094	0591 7254 094	0591 7255 094
	GBS M 97-104/25 Sk	97-104	3 13/16-4 1/6"	0591 7251 101	0591 7252 101	0591 7254 101	0591 7255 101
	GBS M 104-112/25 Sk	104-112	4 1/16-4 7/16"	0591 7251 108	0591 7252 108	0591 7254 108	0591 7255 108
30	GBS M 112-121/25 Sk	112-121	4 7/16-4 3/4"	0591 7251 117	0591 7252 117	0591 7254 117	0591 7255 117
	GBS M 121-130/25 Sk	121-130	4 3/4-5 1/8"	0591 7251 126	0591 7252 126	0591 7254 126	0591 7255 126
	GBS M 130-140/30 Sk	130-140	5 1/8-5 1/2"	0591 7301 135	0591 7302 135	0591 7304 135	0591 7305 135
	GBS M 140-150/30 Sk	140-150	5 1/2-5 15/16"	0591 7301 145	0591 7302 145	0591 7304 145	0591 7305 145
	GBS M 150-162/30 Sk	150-162	5 15/16-6 3/8"	0591 7301 156	0591 7302 156	0591 7304 156	0591 7305 156
	GBS M 162-174/30 Sk	162-174	6 3/8-6 7/8"	0591 7301 168	0591 7302 168	0591 7304 168	0591 7305 168
30	GBS M 174-187/30 Sk	174-187	6 7/8-7 3/8"	0591 7301 181	0591 7302 181	0591 7304 181	0591 7305 181
	GBS M 187-200/30 Sk	187-200	7 3/8-7 7/8"	0591 7301 194	0591 7302 194	0591 7304 194	0591 7305 194
	GBS M 200-213/30 Sk	200-213	7 7/8-8 3/8"	0591 7301 207	0591 7302 207	0591 7304 207	0591 7305 207
	GBS M 213-226/30 Sk	213-226	8 3/8-8 7/8"	0591 7301 220	0591 7302 220	0591 7304 220	0591 7305 220
	GBS M 226-239/30 Sk	226-239	8 7/8-9 7/16"	0591 7301 233	0591 7302 233	0591 7304 233	0591 7305 233
	GBS M 239-252/30 Sk	239-252	9 7/16-9 15/16"	0591 7301 246	0591 7302 246	0591 7304 246	0591 7305 246
	GBS M 252-265/30 Sk	252-265	9 15/16-10 7/16"	0591 7301 259	0591 7302 259	0591 7304 259	0591 7305 259
	GBS M 265-278/30 Sk	265-278	10 7/16-10 15/16"	0591 7301 272	0591 7302 272	0591 7304 272	0591 7305 272
	GBS M 279-291/30 Sk	279-291	11-11 7/16"	0591 7301 285	0591 7302 285	0591 7304 285	0591 7305 285
	GBS M 292-304/30 Sk	292-304	11 1/2-12"	0591 7301 298	0591 7302 298	0591 7304 298	0591 7305 298

* These diameters are full trunnions and do not feature a mechanically locked closure, they are spot-welded.

** ISK bolt for W5 material



GBS – VERSIONS

GBS STC – with solid trunnions



To suit the requirements of all markets, NORMACLAMP® GBS is also available with solid trunnions. Available on request in band width 18, 20, 25 and 30 mm in both materials (W1 and W4).

Main advantage

Strong robustness

Materials

W1, W4



Refer to page 195

GBS QRC – with quick release closure



NORMACLAMP® GBS is also available with a quick release closure. The bolt on the closure is easy to release, ensuring straightforward installation and removal. Available on request in band width 18, 20, 25 and 30 mm in both materials (W1 and W2).

Main advantage

Easy to install

Materials

W1, W2



Refer to page 195

GBS – Multi-parts



NORMACLAMP® GBS is also available in a multi-part version for bigger diameters. Available on request in band width 18, 20, 25 and 30 mm in materials (W1, W2, W4 and W5).

Main advantage

Suitable for big diameter hoses

Material

W1, W2, W4, W5



Refer to page 195

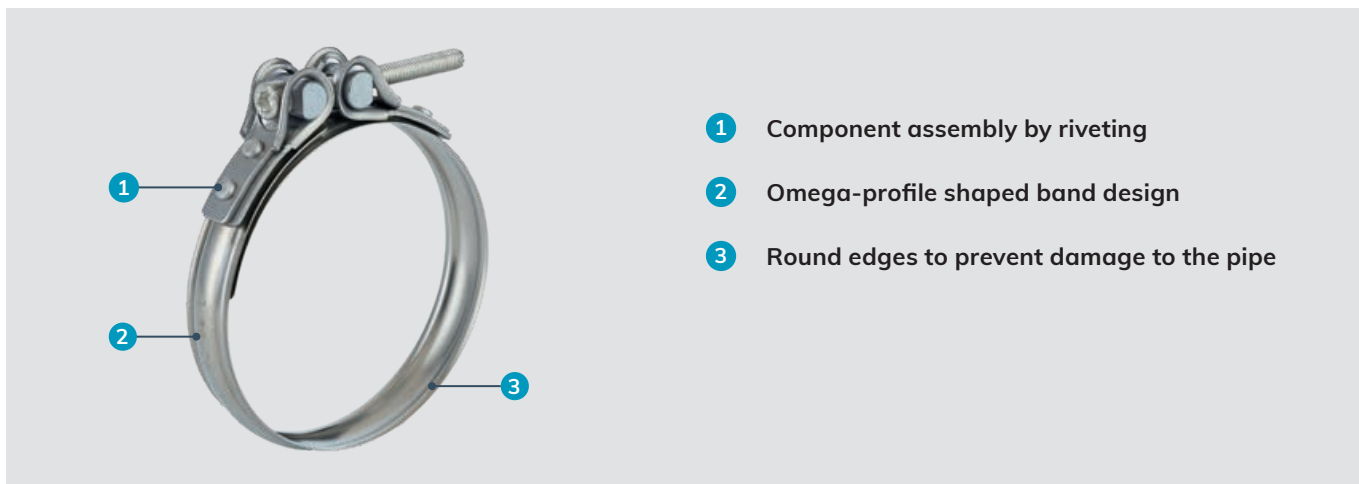

- 1 Component assembly by riveting
- 2 Omega-profile shaped band design
- 3 Round edges to prevent damage to the pipe

Connecting hoses for charged air application

NORMACLAMP® CC is a high performance clamp designed to connect rubber or silicon hoses in high pressure applications. It produces a constantly sealed joint between turbocharger and engine under extremely high temperature and pressure variations.

Advantages at a glance

- ✓ Uniform radial distribution of clamping forces
- ✓ No intercrystalline corrosion
- ✓ High surface pressure compared to flat band clamps
- ✓ Spring function included in omega profile band

Applications

Automotive industry – charged air for turbochargers

Materials

W1	W2	W3	W4	W5
		x		

Technical data & Ordering information

NORMACLAMP® CC			
Width	Designation	Clamping ranges	W3 Product No.
		in mm	
17	CC 70-72	70 - 72	0596 6001 072
	CC 72-74	72 - 74	0596 6001 074
	CC 80-82	80 - 82	0596 6001 082
	CC 82-84	82 - 84	0596 6001 084
	CC 84-86	84 - 86	0596 6001 086
	CC 86-88	86 - 88	0596 6001 088
	CC 88-90	88 - 90	0596 6001 090
	CC 90-92	90 - 92	0596 6001 092
	CC 92-94	92 - 94	0596 6001 094
	CC 94-96	94 - 96	0596 6000 096
	CC 96-98	96 - 98	0596 6000 098
	CC 98-100	98 - 100	0596 6000 100
	CC 100-102	100 - 102	0596 6000 102
	CC 102-104	102 - 104	0596 6000 104
	CC 104-106	104 - 106	0596 6000 106
	CC 106-108	106 - 108	0596 6001 108
	CC 108-110	108 - 110	0596 6001 110
	CC 110-112	110 - 112	0596 6000 112
	CC 112-114	112 - 114	0596 6000 114
	CC 114-116	114 - 116	0596 6000 116
CC 120-122	120 - 122	0596 6000 122	
CC 122-124	122 - 124	0596 6000 124	
CC 124-126	124 - 126	0596 6000 126	
CC 132-134	132 - 134	0596 6000 134	
CC 134-136	134 - 136	0596 6000 136	



- 1 Quick close and release**
- Secure over-center lever for manual opening and closing without the need for installation tools
- 2 Bridge**
- Optimum hose protection

Quick-release clamps

NORMACLAMP® SVS and NORMACLAMP® SVS P clamps are secure, flexible joining elements designed for applications where joints need to be closed and released frequently and quickly, such as filtering and filling systems or food industry pipeline systems that are continually being cleaned.

NORMACLAMP® SVS clamps provide optimal protection for hose applications. NORMACLAMP® SVS P clamps provide optimal protection for pipe applications. NORMACLAMP® SVS PR clamps provide optimal protection for flange applications – see our profile section from page 115.

Main advantage

- ✓ Ideal for frequent handling

Applications

- Machine building
- Chemical industry
- Food and beverage industry
- Railway industry
- Building machines
- Pump and filter

Materials

W1	W2	W3	W4	W5
			x	

Material	Corrosion resistance in salt spray testing
W4	Min. 240 h

Technical data

Quick-release hose clamps (SVS)							
Band width	Minimum \varnothing	Maximum \varnothing	Material W4	Bolts			Closing force N
				(Oe)	Zy \ominus	M	
15	80	500	0.6	(•)	•	6	80
20	80	500	0.8	(•)	•	6	80
25	80	500	1.0	(•)	•	6	80

Technical data & Ordering information

NORMACLAMP® SVS			
Diameter in mm	Material W4 Product No.		
	Band width		
	15 mm	20 mm	25 mm
80 - 90	0565 0154 ...	0565 0204 ...	0565 0254 ...
up to 100	0565 0154 ...	0565 0204 ...	0565 0254 ...
up to 110	0565 0154 ...	0565 0204 ...	0565 0254 ...
up to 120	0565 0154 ...	0565 0204 ...	0565 0254 ...
up to 130	0565 0154 ...	0565 0204 ...	0565 0254 ...
up to 140	0565 0154 ...	0565 0204 ...	0565 0254 ...
up to 150	0565 0154 ...	0565 0204 ...	0565 0254 ...
up to 160	0565 0154 ...	0565 0204 ...	0565 0254 ...
up to 170	0565 0154 ...	0565 0204 ...	0565 0254 ...
up to 180	0565 0154 ...	0565 0204 ...	0565 0254 ...
up to 190	0565 0154 ...	0565 0204 ...	0565 0254 ...
up to 200	0565 0154 ...	0565 0204 ...	0565 0254 ...
up to 210	0565 0154 ...	0565 0204 ...	0565 0254 ...
up to 220	0565 0154 ...	0565 0204 ...	0565 0254 ...
up to 230	0565 0154 ...	0565 0204 ...	0565 0254 ...
up to 240	0565 0154 ...	0565 0204 ...	0565 0254 ...
up to 250	0565 0154 ...	0565 0204 ...	0565 0254 ...
up to 260	0565 0154 ...	0565 0204 ...	0565 0254 ...
up to 270	0565 0154 ...	0565 0204 ...	0565 0254 ...
up to 280	0565 0154 ...	0565 0204 ...	0565 0254 ...
up to 290	0565 0154 ...	0565 0204 ...	0565 0254 ...
up to 300	0565 0154 ...	0565 0204 ...	0565 0254 ...

... = Ø without decimals in mm

Additional diameters available on request

SVS – VERSIONS

SVS P



NORMACLAMP® SVS P clamps provide optimal protection for pipe applications. Available in band widths of 15, 20 and 25 mm on request.

Advantages at a glance

- Closure can be opened and closed easily by hand
- No installation tools required
- Ideal for frequent handling

Material

W4

Eyelet bolt



As an alternative, the NORMACLAMP® SVS clamp closure can be fitted with an eyelet bolt. This can be particularly useful if gloves are worn during installation. Available in band widths of 15, 20 and 25 mm on request.

Advantages at a glance

- Eyelet bolt suitable for light duty series
- Easy to install even if wearing gloves

Material

W4

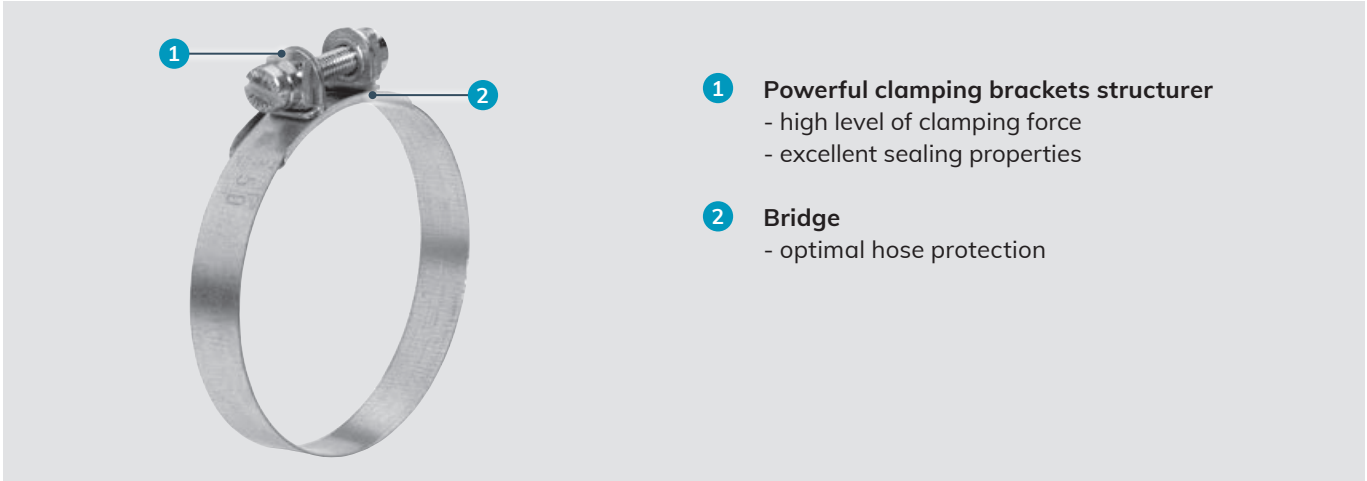

- 1 Powerful clamping brackets structure**
 - high level of clamping force
 - excellent sealing properties
- 2 Bridge**
 - optimal hose protection

DIN 3016, DIN 3017

Thanks to their robust clamping brackets structure featuring metric bolts, NORMACLAMP® S/SP clamps provide a high level of clamping force. The two-part version is recommended for exceptionally high pressure and tensile loads.



Advantages at a glance

- ✓ High level of clamping force
- ✓ Even contact pressure
- ✓ Elbow fittings, brackets or lugs can be attached
- ✓ Clamps can be fitted with a rubber profile to absorb vibrations and protect against the ingress of creeping water

Applications

- Machine building
- Chemical industry
- Irrigation systems
- Ship manufacturing
- Railway industry
- Agricultural machines
- Building machines
- Engine manufacturing
- Pump and filter

Materials



W1	W2	W3	W4	W5
			x*	x

* Only for the 30 mm band width

Material	Corrosion resistance in salt spray testing
W1	Min. 72 h
W5	Min. 400 h

NORMACLAMP® S/SP					
Band width b ₁	Minimum Ø in mm	Material thickness in mm			
		S		SP	
		W1	W5	W1	W5
5	5	0.2	–	0.2	–
7	6	0.3/0.4	0.4	0.4	0.4
9	9	0.4	0.4	0.6	0.4
12	12	0.5	0.5	0.7	0.5
15	20	0.6	0.6	0.8	0.6
20	25	1.0	0.8	(up to ø 47) 1.0 (from ø 48) 1.25	0.8
25	50	1.25	1.0	1.25/1.5	1

Bolts

NORMACLAMP® S/SP			
Band width mm	Zy 	Sz 	Sk 
5	M 2x12		
7	M 3x16		
9	M 4x22	M 4 x 20	
12		M 5x25	
15		M 6x30	
20		M 8x40	
25			M 10x45

Static torques

NORMACLAMP® S/SP		
Band width b ₁ mm	Static tightening torque Nm	Static test torque Nm
	max.	
7	0.5	0.6
9	1.2	1.5
12	1.5	1.8
15	4	4.8
20	12	14.5
25	30	36

Static torques according to DIN 3017-2

Technical data & Ordering information

NORMACLAMP® S										
Clamping diameter, mm	W1 Product No.					W5 Product No.				
	Band width					Band width				
	7 mm Zy	9 mm Zy	12 mm Sz	15 mm Sz	20 mm Sz	7 mm Zy	9 mm Zy	12 mm Sz	15 mm Sz	20 mm Sz
6	0110 8980 006					0110 0700 006				
7	0110 8980 007					0110 0700 007				
8	0110 8980 008					0110 0700 008				
9	0110 8980 009	0120 8980 009				0110 0700 009	0120 0700 009			
10	0110 8980 010	0120 8980 010				0110 0700 010	0120 0700 010			
11	0110 8980 011	0120 8980 011				0110 0700 011	0120 0700 011			
12	0110 8980 012	0120 8980 012	0130 0005 012			0110 0700 012	0120 0700 012	0130 0705 012		
13		0120 8980 013	0130 0005 013				0120 0700 013	0130 0705 013		
14		0120 8980 014	0130 0005 014				0120 0700 014	0130 0705 014		
15		0120 8980 015	0130 0005 015				0120 0700 015	0130 0705 015		
16		0120 8980 016	0130 0005 016				0120 0700 016	0130 0705 016		
17		0120 8980 017	0130 0005 017				0120 0700 017	0130 0705 017		
18		0120 8980 018	0130 0005 018				0120 0700 018	0130 0705 018		
19		0120 8980 019	0130 0005 019	0140 0000 019			0120 0700 019	0130 0705 019	0140 0700 019	
20		0120 8980 020	0130 0005 020	0140 0000 020			0120 0700 020	0130 0705 020	0140 0700 020	
21		0120 8980 021	0130 0005 021	0140 0000 021			0120 0700 021	0130 0705 021	0140 0700 021	
22		0120 8980 022	0130 0005 022	0140 0000 022			0120 0700 022	0130 0705 022	0140 0700 022	
23		0120 8980 023	0130 0005 023	0140 0000 023			0120 0700 023	0130 0705 023	0140 0700 023	
24		0120 8980 024	0130 0005 024	0140 0000 024			0120 0700 024	0130 0705 024	0140 0700 024	
25		0120 8980 025	0130 0005 025	0140 0000 025			0120 0700 025	0130 0705 025	0140 0700 025	
26		0120 8980 026	0130 0005 026	0140 0000 026			0120 0700 026	0130 0705 026	0140 0700 026	
27		0120 8980 027	0130 0005 027	0140 0000 027			0120 0700 027	0130 0705 027	0140 0700 027	
28		0120 8980 028	0130 0005 028	0140 0000 028			0120 0700 028	0130 0705 028	0140 0700 028	
29		0120 8980 029	0130 0005 029	0140 0000 029			0120 0700 029	0130 0705 029	0140 0700 029	
30		0120 8980 030	0130 0005 030	0140 0000 030	0150 0000 030		0120 0700 030	0130 0705 030	0140 0700 030	0150 0700 030
31		0120 8980 031	0130 0005 031	0140 0000 031	0150 0000 031			0130 0705 031	0140 0700 031	0150 0700 031
32		0120 8980 032	0130 0005 032	0140 0000 032	0150 0000 032			0130 0705 032	0140 0700 032	0150 0700 032
33				0140 0000 033	0150 0000 033			0130 0705 033	0140 0700 033	0150 0700 033
34				0140 0000 034	0150 0000 034			0130 0705 034	0140 0700 034	0150 0700 034
35				0140 0000 035	0150 0000 035			0130 0705 035	0140 0700 035	0150 0700 035
36				0140 0000 036	0150 0000 036				0140 0700 036	0150 0700 036
37					0150 0000 037				0140 0700 037	0150 0700 037
38					0150 0000 038				0140 0700 038	0150 0700 038

Additional diameters available on request.

Available in W4 on request.

Available in 25 mm and 30 mm band width on request.

NORMACLAMP® S										
Clamping diameter, mm	W1 Product No.					W5 Product No.				
	Band width					Band width				
	7 mm Zy	9 mm Zy	12 mm Sz	15 mm Sz	20 mm Sz	7 mm Zy	9 mm Zy	12 mm Sz	15 mm Sz	20 mm Sz
39					0150 0000 039					0140 0700 039 0150 0700 039
40					0150 0000 040					0140 0700 040 0150 0700 040
41					0150 0000 041					0150 0700 041
42					0150 0000 042					0150 0700 042
43					0150 0000 043					0150 0700 043
44					0150 0000 044					0150 0700 044
45					0150 0000 045					0150 0700 045
46					0150 0000 046					0150 0700 046
47					0150 0000 047					0150 0700 047
48					0150 0000 048					0150 0700 048
49					0150 0000 049					0150 0700 049
50					0150 0000 050					0150 0700 050
51					0150 0000 051					0150 0700 051
52					0150 0000 052					0150 0700 052
53					0150 0000 053					0150 0700 053
54					0150 0000 054					0150 0700 054
55					0150 0000 055					0150 0700 055
56					0150 0000 056					0150 0700 056
57					0150 0000 057					0150 0700 057
58					0150 0000 058					0150 0700 058
59					0150 0000 059					0150 0700 059
60					0150 0000 060					0150 0700 060
61					0150 0000 061					0150 0700 061
62					0150 0000 062					0150 0700 062
63					0150 0000 063					0150 0700 063
64					0150 0000 064					0150 0700 064
65					0150 0000 065					0150 0700 065
66					0150 0000 066					0150 0700 066
67					0150 0000 067					0150 0700 067
68					0150 0000 068					0150 0700 068
69					0150 0000 069					0150 0700 069
70					0150 0000 070					0150 0700 070
71					0150 0000 071					
72					0150 0000 072					
73					0150 0000 073					
74					0150 0000 074					
75					0150 0000 075					
76					0150 0000 076					
77					0150 0000 077					
78					0150 0000 078					
79					0150 0000 079					
80					0150 0000 080					
81					0150 0000 081					
82					0150 0000 082					
83					0150 0000 083					
84					0150 0000 084					
85					0150 0000 085					
86					0150 0000 086					
87					0150 0000 087					
88					0150 0000 088					

Additional diameters available on request.
 Available in W4 on request.
 Available in 25 mm and 30 mm band width on request.

NORMACLAMP® S										
Clamping diameter, mm	W1 Product No.					W5 Product No.				
	Band width					Band width				
	7 mm Zy	9 mm Zy	12 mm Sz	15 mm Sz	20 mm Sz	7 mm Zy	9 mm Zy	12 mm Sz	15 mm Sz	20 mm Sz
89					0150 0000 089					
90					0150 0000 090					
91					0150 0000 091					
92					0150 0000 092					
93					0150 0000 093					
94					0150 0000 094					
95					0150 0000 095					
96					0150 0000 096					
97					0150 0000 097					
98					0150 0000 098					
99					0150 0000 099					
100					0150 0000 100					
101					0150 0000 101					
102					0150 0000 102					
103					0150 0000 103					
104					0150 0000 104					
105					0150 0000 105					
106					0150 0000 106					
107					0150 0000 107					
108					0150 0000 108					
109					0150 0000 109					
110					0150 0000 110					
111					0150 0000 111					
112					0150 0000 112					
113					0150 0000 113					
114					0150 0000 114					
115					0150 0000 115					
116					0150 0000 116					
117					0150 0000 117					
118					0150 0000 118					
119					0150 0000 119					
120					0150 0000 120					

Additional diameters available on request.
 Available in W4 on request.
 Available in 25 mm and 30 mm band width on request.

SP Single



NORMACLAMP® SP Single is suitable for attaching rubber and plastic hoses as well as rubber sleeves to pipe ends or hose spigots. This clamp can be used for clamping containers, pipes and cables.

Materials

W1, W5 on request

SP Double



NORMACLAMP® SP Double enables larger diameters to be clamped easily thanks to its multi-part design.

Materials

W1, W5 on request

SPGU



NORMACLAMP® SPGU has a rubber profile that protects against vibration and creeping water. It is also sound-absorbent and protects against contact corrosion.

Materials

W1, W5 on request



- 1 Self-adjusting diameter**
- compensation for tolerances at the outer diameter of the hose
- 2 Color coding**
- a rapid way of visually distinguishing between nominal diameters
- 3 Protruding tool gripping points**
- easy and safe installation
- 4 Date of manufacture and machine number indicated**
- 5 Single lock-in point**
- installation indicator for easy visual checking
- 6 Band material with rounded outer edges**
- hose protection

One-piece hose clips

NORMACLAMP® COBRA products are bolt-free, one-piece hose clips. Their low overall height enables precise installation in even the tightest of spaces. NORMACLAMP® COBRA clamps are quick and easy to install.



Advantages at a glance

- ✓ Bolt-free hose clip in one piece
- ✓ Quick, easy and safe installation
- ✓ Maintenance-free fit

Applications

- Machine building
- White goods
- Chemical industry
- Irrigation systems
- Food and beverage industry
- Agricultural machines
- Engine manufacturing
- Pump and filter
- Suction lines
- Ventilation lines
- Washing machine hoses
- Pneumatic lines

Materials

W1	W2	W3	W4	W5
			x	

Material	Corrosion resistance in salt spray testing
W4	Min. 240 h

Selecting the right nominal diameter

Push the hose onto the spigot and measure the outer diameter D_o .

The applicable nominal diameter d_1 is then matched to this outer diameter D_o .

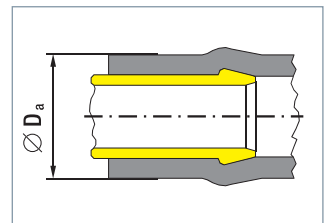

If required, we can send you an appropriate sample before you place your order.

If you have any additional, application-specific questions, we will be happy to advise you in more detail.

Technical data & Ordering information

NORMACLAMP® COBRA						
Width	Designation	Clamping ranges		Nominal diameter	W4 Product No.	Color
		in mm	in inches			
7	COBRA 7.5/7	8-9	5/16-3/8"	7.5	0107 7000 075	White
	COBRA 8.0/7	8.5-9.5	5/16-3/8"	8.0	0107 7000 008	Yellow
	COBRA 8.5/7	9-10	3/8-3/8"	8.5	0107 7000 085	Green
	COBRA 9.0/7	9.5-10.5	3/8-3/8"	9.0	0107 7000 009	Purple
	COBRA 9.5/7	10-11	3/8-7/16"	9.5	0107 7000 095	Black
	COBRA 10.0/7	10.5-11.5	3/8-7/16"	10	0107 7000 010	White
	COBRA 10.5/7	11-12	7/16-1/2"	10.5	0107 7000 105	Yellow
	COBRA 11.0/7	11.5-12.5	7/16-1/2"	11	0107 7000 011	Green
	COBRA 11.5/7	12-13	1/2-1/2"	11.5	0107 7000 115	Purple
8	COBRA 12/8	12.5-14	1/2-9/16"	12	0108 7006 012	Black
	COBRA 13/8	13.5-15	1/2-5/8"	13	0108 7006 013	Yellow
	COBRA 14/8	14.5-16	9/16-5/8"	14	0108 7006 014	Purple
	COBRA 15/8	15.5-17	5/8-11/16"	15	0108 7006 015	White
	COBRA 16/8	16.5-18	5/8-3/4"	16	0108 7006 016	Green
	COBRA 17/8	17.5-19	11/16-3/4"	17	0108 7006 017	Black
	COBRA 18/8	18.5-20	3/4-13/16"	18	0108 7006 018	Yellow
	COBRA 19/8	19.5-21	3/4-13/16"	19	0108 7006 019	Purple
	COBRA 20/8	20.5-22	13/16-7/8"	20	0108 7006 020	White
	COBRA 21/8	21.5-23	13/16-7/8"	21	0108 7006 021	Green
	COBRA 22/8	22.5-24	7/8-15/16"	22	0108 7006 022	Black
	COBRA 23/8	23.5-25	7/8-1"	23	0108 7006 023	Yellow
	COBRA 24/8	24.5-26	15/16-1 1/16"	24	0108 7006 024	Purple
	COBRA 25/8	25.5-27	1-1 1/16"	25	0108 7006 025	White
	COBRA 26/8	26.5-28	1 1/16-1 1/8"	26	0108 7006 026	Green
	COBRA 27/8	27.5-29	1 1/16-1 1/8"	27	0108 7006 027	Black
	COBRA 28/8	28.5-30	1 1/8-1 3/16"	28	0108 7006 028	Yellow
	COBRA 29/8	29.5-31	1 1/8-1 1/4"	29	0108 7006 029	Purple
	COBRA 30/8	30.5-32	1 3/16-1 1/4"	30	0108 7006 030	White

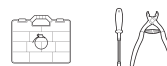

Refer to pages 187, 191 and 193

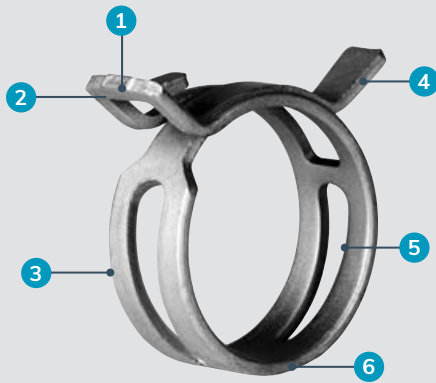

- 1 Lot number stamped on**
- reliable traceability
- 2 NORMA® logo**
- a visible sign of quality
- 3 Base and Topcoat Coating System**
- double layered chromium VI-free coating
- provides optimum corrosion and chemical protection
- 4 Nominal diameter stamped on**
- prevents mistakes
- 5 Special design**
- even distribution of clamping force and excellent roundness
- 6 Rounded band edges**
- optimum hose protection

Springband hose clamps in acc. with DIN 3021

NORMACLAMP® FBS springband hose clamps are the perfect choice for hose spigot systems that are exposed to significant temperature fluctuations. Once installed, their dynamic spring properties ensure an automatic re-tensioning effect over long periods of time. Even at low temperatures, this mechanism still enables sufficiently high levels of radial clamping force to be achieved, which in turn ensures excellent sealing reliability. With NORMACLAMP® FBS clamps even hoses that have a tendency to “creep” can be joined securely. Manual or pneumatic tools are used for professional installation.

Advantages at a glance

- ✓ One-piece, bolt-free hose clamp
- ✓ Even distribution of clamping force
- ✓ Optimum roundness
- ✓ Temperature resistance from -40 °C to 200 °C
- ✓ Automatically re-tensions to accommodate temperature fluctuations
- ✓ Clear traceability due to batch numbering

Applications

- Machine building
- White goods
- Agricultural machines
- Engine manufacturing
- Cooling and heating water circuits
- Fuel vent system
- Air ducts
- Water and brine outlet lines

Short description

- Dynamic clamp
- Band material C 75 S
- Coating containing zinc; no chromium (VI)
- Nominal diameter of 13 – 70 mm in various graduations

Materials

Material	Zinc/aluminum coating	Organic coating
C 75 S	Base coat	Topcoat
Corrosion resistance in salt spray testing		
Up to 720 h according to DIN EN ISO 9227		

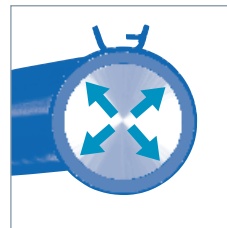

At high temperatures

- Hose diameter increases
- FBS adapts to internal pressure

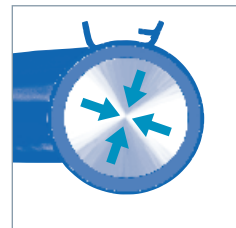

At low temperatures

- Hose diameter decreases
- FBS re-tensions
- Clamping force is retained and clamp provides perfect seal

Determine clamp size

To determine which clamp is right for you, follow these steps:

1. Push the hose onto the spigot and measure $D_{min.}$ and $D_{max.}$
2. Based on the $D_{min.}$ value, determine the nominal diameter (D_n) of the clamp in question. $D_n = D_{min.}$
3. Compare the $D_{max.}$ value with the minimum diameter ($D_{0 min.}$) specified for the open clamp and select the clamp that is appropriate. $D_{0 min.} \geq D_{max.}$

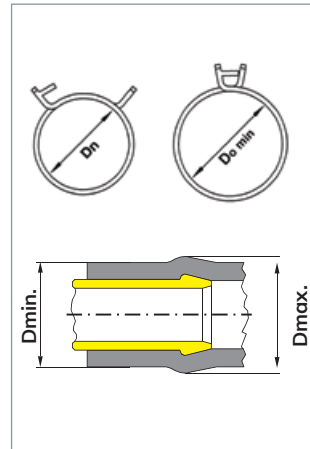

If required, we can send you an appropriate sample before you place your order. If you have any additional, application-specific questions, we will be happy to advise you in more detail.

Technical data & Ordering information

NORMACLAMP® FBS STANDARD							
Width	Designation	D _n mm	D _n in inches	D ₀ m in mm	D ₀ min in inches	Material C 75 S Product No.	
						Black	Silver
12	FBS 13/12	13	1/2"	14.5	9/16"	0112 8024 013	0112 8074 013
	FBS 14/12	14	9/16"	15.8	5/8"	0112 8024 014	0112 8074 014
	FBS 15/12	15	9/16"	16.8	11/16"	0112 8024 015	0112 8074 015
	FBS 16/12	16	5/8"	17.5	11/16"	0112 8024 016	0112 8074 016
	FBS 17/12	17	11/16"	18.5	3/4"	0112 8024 017	0112 8074 017
	FBS 18/12	18	11/16"	19	3/4"	0112 8024 018	0112 8074 018
	FBS 19/12	19	3/4"	21	13/16"	0112 8024 019	0112 8074 019
	FBS 20/12	20	13/16"	21.6	7/8"	0112 8024 020	0112 8074 020
	FBS 21/12	21	13/16"	22.5	7/8"	0112 8024 021	0112 8074 021
	FBS 22/12	22	7/8"	24.5	15/16"	0112 8024 022	0112 8074 022
	FBS 23/12	23	15/16"	24.7	1"	0112 8024 023	0112 8074 023
	FBS 24/12	24	15/16"	26	1"	0112 8024 024	0112 8074 024
	FBS 25/12	25	1"	27	1 1/16"	0112 8024 025	0112 8074 025
	FBS 26/12	26	1"	28	1 1/8"	0112 8024 026	0112 8074 026
	FBS 27/12	27	1 1/16"	29	1 1/8"	0112 8024 027	0112 8074 027
	FBS 28/12	28	1 1/8"	30.5	1 3/16"	0112 8024 028	0112 8074 028
	FBS 29/12	29	1 1/8"	31.5	1 1/4"	0112 8024 029	0112 8074 029
	FBS 30/12	30	1 3/16"	32.5	1 1/4"	0112 8024 030	0112 8074 030
	FBS 32/12	32	1 1/4"	34.5	1 3/8"	0112 8024 032	0112 8074 032
	FBS 35/12	35	1 3/8"	38	1 1/2"	0112 8024 035	0112 8074 035
	FBS 36/12	36	1 7/16"	39	1 9/16"	0112 8024 036	0112 8074 036
	FBS 38/12	38	1 1/2"	41.5	1 5/8"	0112 8024 038	0112 8074 038
	FBS 40/12	40	1 9/16"	42.5	1 11/16"	0112 8024 040	0112 8074 040
	FBS 42/12	42	1 5/8"	44.5	1 3/4"	0112 8024 042	0112 8074 042
	FBS 44/12	44	1 3/4"	46.5	1 13/16"	0112 8024 044	0112 8074 044
	FBS 46/12	46	1 13/16"	49	1 15/16"	0112 8024 046	0112 8074 046
	FBS 47/12	47	1 7/8"	50	2"	0112 8024 047	0112 8074 047
	FBS 50/12	50	2"	53	2 1/16"	0112 8024 050	0112 8074 050
	FBS 55/12	55	2 3/16"	58	2 1/4"	0112 8024 055	0112 8074 055
	FBS 60/12	60	2 3/8"	63	2 1/2"	0112 8024 060	0112 8074 060

Special diameters available on request



Refer to pages 191 and 194

FBS – VERSIONS

FBS R



The NORMACLAMP® FBS R was designed with the aim of achieving the smallest overall height that was technically possible so that it could be used in difficult installation conditions.

Main advantage

Space-saving clamp

Material

C75S



Refer to pages 191 and 194

FBS C



A pre-opened clamp that must be glued into place on the hose. Ask your sales representative for the gluing instructions. The retaining mechanism for this version is part of the band and is integrated into the clamp.

Advantages at a glance

- Pre-assembled clamp
- Ready to use

Material

C75S



Refer to page 191

FBS HC



A pre-opened version that is secured by a plastic clip and can also be glued into place on the hose. Ask your Sales Representative for gluing instructions. Once the clamp has been pushed onto the hose, this clip can be released easily by hand.

Main advantage

Easy to assemble

Material

C75S

FBS MC



A pre-opened version that is secured by a metal clip and can also be glued into place on the hose. Ask your Sales Representative for gluing instructions. The retaining clip for this version is removed by using pliers.

Main advantage

Secured clamp

Material

C75S

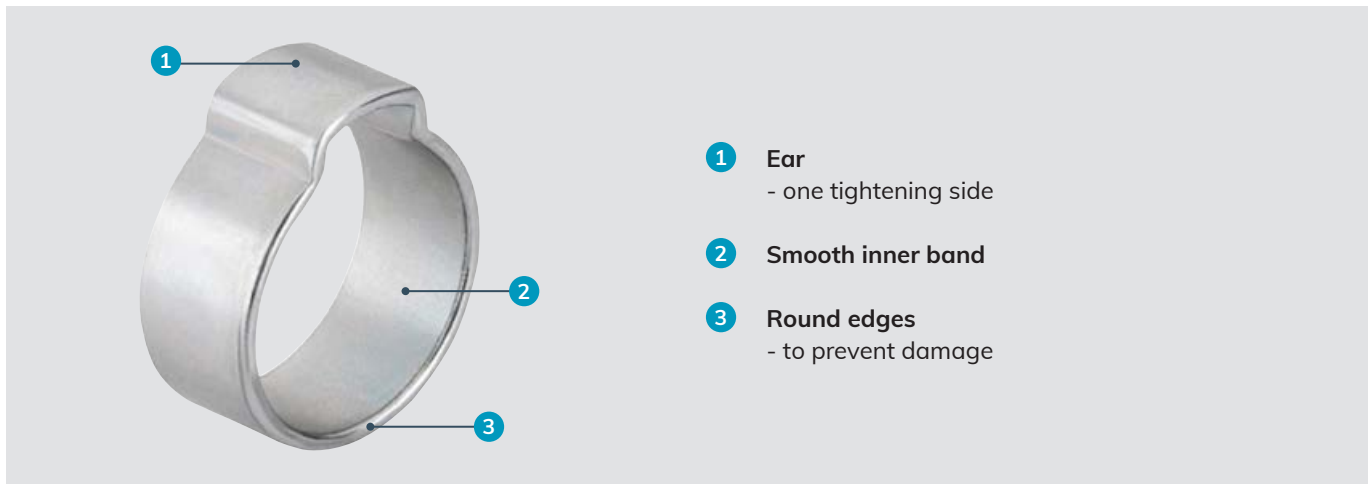

- 1 Ear**
- one tightening side
- 2 Smooth inner band**
- 3 Round edges**
- to prevent damage

One part clamp for low and medium pressure

The NORMACLAMP® Ear Clip Single has no screw. The assembly is fast, simple and safe thanks to the pinching of the ear.

Advantages at a glance

- ✓ Cost effective, and simple alternative to worm drive hose clips
- ✓ Fast and easy to install
- ✓ Ideal in narrow spaces
- ✓ Suitable for definitive fixation of connecting pipes
- ✓ To be assembled with simple ear clip pliers

Applications

- For hoses that convey compressed air or fluid
- Original equipment manufacturing
- Maintenance repair and overhaul

Materials

W1	W2	W3	W4	W5
x			x	

Technical data & Ordering information

NORMACLAMP® EAR CLIP SINGLE					
Width	Description	Clamping ranges		W1 Product No.	W4 Product No.
		in mm	in inches		
6	EAR CLIP SINGLE 8 - 10/6	8 - 10	5/16-3/8"	0110 7010 010	0110 7011 010
	EAR CLIP SINGLE 9 - 11/6.5	9 - 11	3/8-7/16"	0110 7010 011	0110 7011 011
6.5	EAR CLIP SINGLE 10 - 12/6.5	10 - 12	3/8-1/2"	0110 7010 012	0110 7011 012
	EAR CLIP SINGLE 11 - 13/6.5	11 - 13	7/16-1/2"	0110 7010 013	0110 7011 013
7	EAR CLIP SINGLE 12 - 14/7	12 - 14	1/2-9/16"	0110 7010 014	0110 7011 014
	EAR CLIP SINGLE 13 - 15/7	13 - 15	1/2-9/16"		0110 7011 015
	EAR CLIP SINGLE 14 - 16/7	14 - 16	9/16-5/8"	0110 7010 016	0110 7011 016
	EAR CLIP SINGLE 16 - 18/7	16 - 18	5/8-11/16"	0110 7010 018	0110 7011 018



Refer to page 193

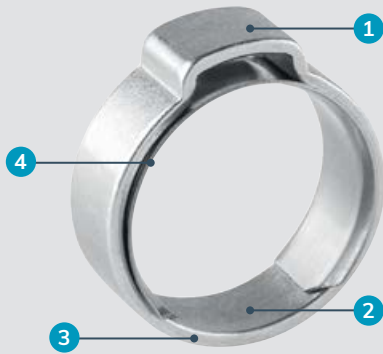

- 1 Ear**
- one tightening side
- 2 Smooth inner band and inner liner**
- for security and roundness
- 3 Round edges**
- to prevent damage
- 4 Inner liner**
- effective and powerful all-round seal

One part clamp for low and medium pressure

The NORMACLAMP® Ear Clip Safe has no screw. The assembly is fast, simple and safe thanks to the pinching of the ear. The inner insert allows a better distribution of the clamping force.

Advantages at a glance

- ✓ Cost effective, and simple alternative to worm drive hose clips
- ✓ Fast and easy to install
- ✓ Ideal in narrow spaces
- ✓ Suitable for definitive fixation of connecting pipes
- ✓ To be assembled with simple ear clip pliers
- ✓ Inner liner for security and better distribution of the clamping force

Applications

- For hoses that convey compressed air or fluid
- Original equipment manufacturing
- Maintenance repair and overhaul

Materials

W1	W2	W3	W4	W5
x			x	

Technical data & Ordering information

NORMACLAMP® EAR CLIP SAFE					
Width in mm	Description	Clamping ranges		W1 Product No.	W4 Product No.
		in mm	in inches		
6	EAR CLIP SAFE 7.5-8.5/6	7.5-8.5	5/16-5/16"	0110 7014 008	0110 7015 008
	EAR CLIP SAFE 8-9.5/6	8-9.5	5/16-3/8"	0110 7014 009	0110 7015 009
6.5	EAR CLIP SAFE 9-10.5/6.5	9-10.5	3/8-7/16"	0110 7014 010	0110 7015 010
	EAR CLIP SAFE 10-11.5/6.5	10-11.5	3/8-7/16"	0110 7014 011	0110 7015 011
	EAR CLIP SAFE 10.5-12.5/6.5	10.5-12.5	7/16-1/2"	0110 7014 012	0110 7015 012
7	EAR CLIP SAFE 11.5-13.3/7	11.5-13.3	7/16-1/2"	0110 7014 013	0110 7015 013
	EAR CLIP SAFE 12.5-14.5/7	12.5-14.5	1/2-9/16"		0110 7015 014
	EAR CLIP SAFE 13-15.3/7	13-15.3	1/2-5/8"	0110 7014 015	0110 7015 015
	EAR CLIP SAFE 14-16/7	14-16	9/16-1/4"		0110 7015 016
	EAR CLIP SAFE 15-17.3/7	15-17.3	9/16-11/16"	0110 7014 017	0110 7015 017
7.5	EAR CLIP SAFE 16-18.3/7.5	16-18.3	1/4-3/4"		0110 7015 018
	EAR CLIP SAFE 17-19.3/7.5	17-19.3	11-16-3/4"		0110 7015 019

Refer to page 193 

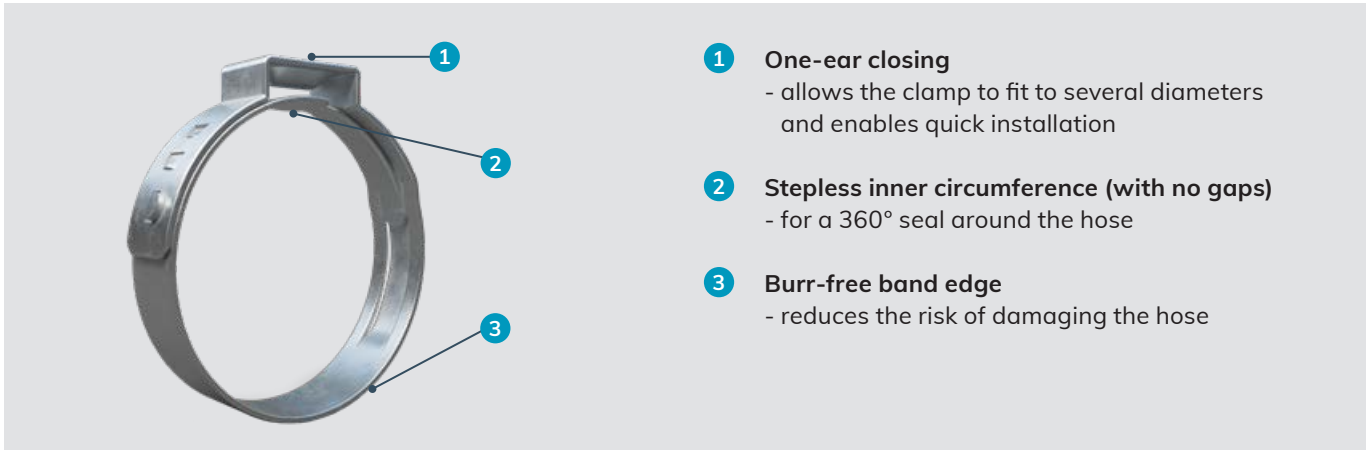

- 1 One-ear closing**
- allows the clamp to fit to several diameters and enables quick installation
- 2 Stepless inner circumference (with no gaps)**
- for a 360° seal around the hose
- 3 Burr-free band edge**
- reduces the risk of damaging the hose

Ear clip with 360° uniform compression sealing

NORMACLAMP® Ear Clip Pro³⁶⁰ has no steps or gaps on the inner circle of the clamp, thus enabling a 360° seal on the hose. Thanks to the bolt-free design the clamp can be installed precisely in tight spaces.

Advantages at a glance

- ✓ 360° seal on the hose
- ✓ Quick installation
- ✓ Low profile for tight spaces
- ✓ Burr-free band edge

Applications

Ear Clip Pro³⁶⁰ is well suited to applications involving poly and braided tubing that require a complete seal, e.g. for:

- Automotive aftermarket
- White goods industry
- Food & beverage industry

Materials

W1	W2	W3	W4	W5
			x	

Technical drawing

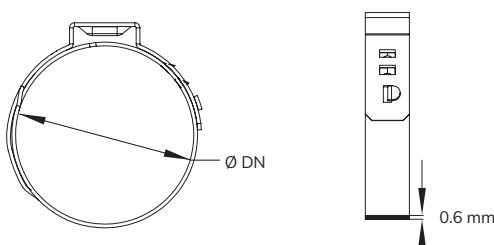

Technical data & Ordering information

NORMACLAMP® EAR CLIP PRO360			
Width in mm	Designation	Ø DN (mm)	W4 Product No.
5	Ear Clip Pro360 6.8-8.0 W4	6.8-8.0	0110 7245 080
	Ear Clip Pro360 7.3-9.0 W4	7.3-9.0	0110 7245 090
	Ear Clip Pro360 7.8-9.5 W4	7.8-9.5	0110 7245 095
	Ear Clip Pro360 8.8-10.5 W4	8.8-10.5	0110 7245 105
	Ear Clip Pro360 9.6-11.3 W4	9.6-11.3	0110 7245 113
7	Ear Clip Pro360 9.8-12.3 W4	9.8-12.3	0110 7247 123
	Ear Clip Pro360 10.3-12.8 W4	10.3-12.8	0110 7247 128
	Ear Clip Pro360 10.8-13.3 W4	10.8-13.3	0110 7247 133
	Ear Clip Pro360 11.3-13.8 W4	11.3-13.8	0110 7247 138
	Ear Clip Pro360 12.0-14.5 W4	12.0-14.5	0110 7247 145
	Ear Clip Pro360 13.2-15.7 W4	13.2-15.7	0110 7247 157
	Ear Clip Pro360 13.5-16.0 W4	13.5-16.0	0110 7247 160
	Ear Clip Pro360 14.3-16.8 W4	14.3-16.8	0110 7247 168
	Ear Clip Pro360 15.0-17.5 W4	15.0-17.5	0110 7247 175
	Ear Clip Pro360 15.3-18.5 W4	15.3-18.5	0110 7247 185
	Ear Clip Pro360 16.6-19.8 W4	16.6-19.8	0110 7247 198
	Ear Clip Pro360 17.8-21.0 W4	17.8-21.0	0110 7247 210
	Ear Clip Pro360 19.4-22.6 W4	19.4-22.6	0110 7247 226
	Ear Clip Pro360 22.4-25.6 W4	22.4-25.6	0110 7247 256
	Ear Clip Pro360 23.9-27.1 W4	23.9-27.1	0110 7247 271
	Ear Clip Pro360 25.4-28.6 W4	25.4-28.6	0110 7247 286
	Ear Clip Pro360 28.4-31.6 W4	28.4-31.6	0110 7247 316
	Ear Clip Pro360 29.9-33.1 W4	29.9-33.1	0110 7247 331

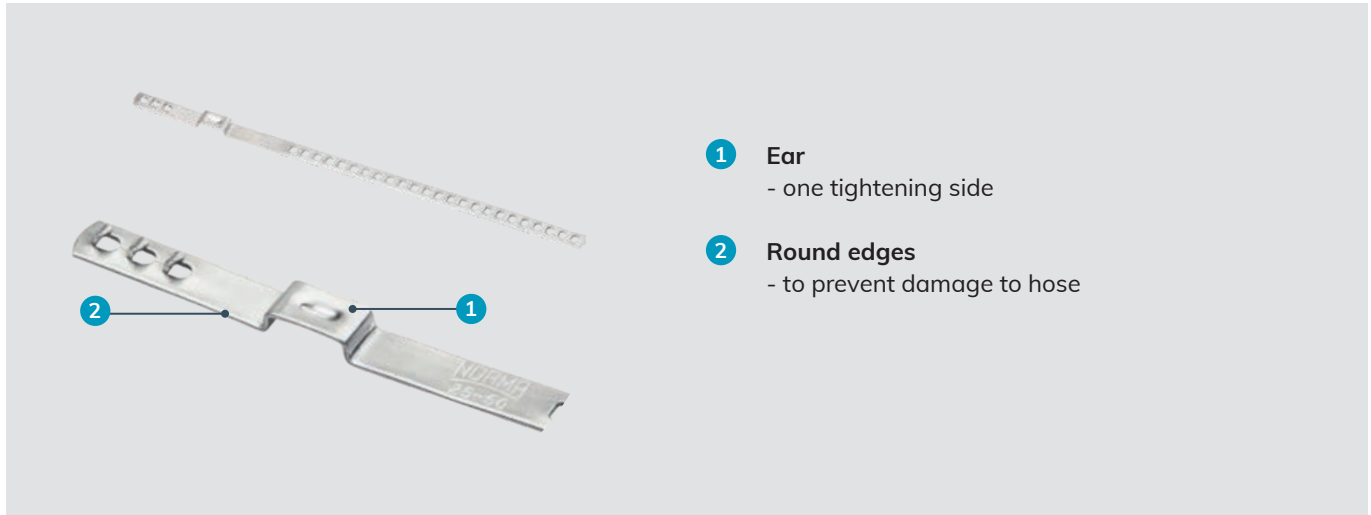

- 1 Ear
- one tightening side
- 2 Round edges
- to prevent damage to hose

Flexible clamp to mount different sizes of rubber boots

The NORMACLAMP® CV Boot Clamp has no screws. The assembly is fast and reliable, thanks to pinching of the ear.

Advantages at a glance

- ✓ Clamps can be adjusted to several diameters
- ✓ Fast and easy installation
- ✓ Robust clamping due to 3 locking teeth

Applications

NORMACLAMP® CV Boot Clamps are used to mount various sizes of rubber boots on drive shafts in passenger and commercial vehicles.

Materials

W1	W2	W3	W4	W5
			x	

Technical data & Ordering information

NORMACLAMP® CV BOOT CLAMP			
Width in mm	Description	Clamping ranges	W4 Product No.
		in mm	
7	CV Boot Clamp 25-50 (100 pcs x 1)	25-50	0110 7016 050
	CV Boot Clamp 40-120 (100 pcs x 1)	40-120	0110 7016 120
	CV Boot Clamp 25-50 (25 pcs x 4)	25-50	0110 5016 050
	CV Boot Clamp 40-120 (25 pcs x 4)	40-120	0110 5016 120



Refer to page 193

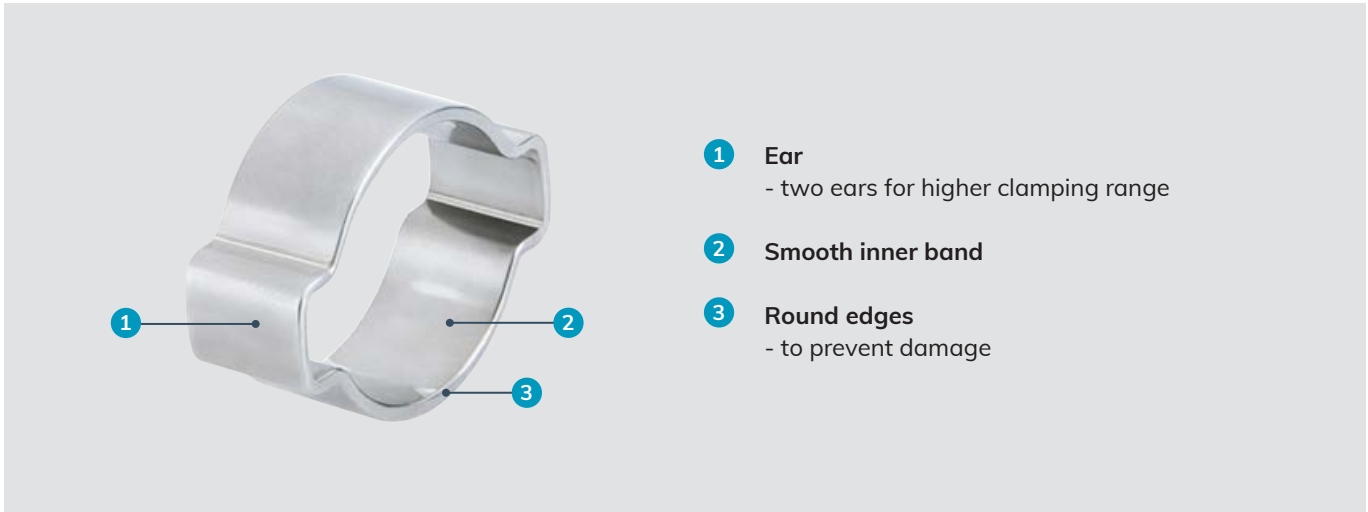

- 1 **Ear**
- two ears for higher clamping range
- 2 **Smooth inner band**
- 3 **Round edges**
- to prevent damage

One part clamp for low and medium pressure

The NORMACLAMP® Ear Clip Double has no screw. The assembly is fast, simple and safe thanks to the pinching of the ears. The two ears enable a better and more constant sealing force. The tightening force is improved.

Advantages at a glance

- ✓ Cost effective, and simple alternative to worm drive hose clips
- ✓ Fast and easy to install
- ✓ Ideal in narrow spaces
- ✓ Suitable for definitive fixation of connecting pipes
- ✓ To be assembled with simple ear clip pliers
- ✓ Extended clamping range

Applications

- For hoses that convey compressed air or fluid
- Original equipment manufacturing
- Maintenance repair and overhaul

Materials

W1	W2	W3	W4	W5
x			x	

EAR CLIP DOUBLE

Technical data & Ordering information

NORMACLAMP® EAR CLIP DOUBLE					
Width in mm	Designation	Clamping ranges		W1 Product No.	W4 Product No.
		in mm	in inches		
6	EAR CLIP DOUBLE 5-7/6	5-7	3/16-1/4"	0110 7012 007	0110 7013 007
	EAR CLIP DOUBLE 7-9/6	7-9	1/4-3/8"	0110 7012 009	0110 7013 009
6.5	EAR CLIP DOUBLE 9-11/6.5	9-11	3/8-7/16"	0110 7012 011	0110 7013 011
	EAR CLIP DOUBLE 10-12/6.5	10-12	3/8-1/2"	0110 7012 012	0110 7013 012
	EAR CLIP DOUBLE 11-13/6.5	11-13	7/16-1/2"	0110 7012 013	0110 7013 013
7	EAR CLIP DOUBLE 13-15/7	13-15	1/2-9/16"	0110 7012 015	0110 7013 015
	EAR CLIP DOUBLE 14-17/7	14-17	9/16-11/16"	0110 7012 017	0110 7013 017
7.5	EAR CLIP DOUBLE 15-18/7.5	15-18	9/16-11/16"	0110 7012 018	0110 7013 018
	EAR CLIP DOUBLE 17-20/7.5	17-20	11/16-13/16"	0110 7012 020	0110 7013 020
8	EAR CLIP DOUBLE 18-21/8	18-21	11/16-13/16"	0110 7012 021	0110 7013 021
	EAR CLIP DOUBLE 20-23/8	20-23	13/16-15/16"	0110 7012 023	0110 7013 023
9	EAR CLIP DOUBLE 22-25/9	22-25	7/8-1"	0110 7012 025	0110 7013 025
10	EAR CLIP DOUBLE 23-27/10	23-27	15/16-1 11/16"	0110 7012 027	
	EAR CLIP DOUBLE 25-28/10	25-28	1-1 1/8"	0110 7012 028	
	EAR CLIP DOUBLE 28-31/10	28-31	1 1/8-1 1/4"	0110 7012 031	
	EAR CLIP DOUBLE 31-34/10	31-34	1 1/4-1 5/16"	0110 7012 034	
	EAR CLIP DOUBLE 34-37/10	34-37	1 5/16-1 7/16"	0110 7012 037	
	EAR CLIP DOUBLE 37-40/10	37-40	1 7/16-1 9/16"	0110 7012 040	
	EAR CLIP DOUBLE 40-43/10	40-43	1 9/16-1 11/16"	0110 7012 043	
	EAR CLIP DOUBLE 43-46/10	43-46	1 11/16-1 13/16"	0110 7012 046	



Refer to page 193

NORMACONNECT® – Pipe Connections

The perfect method of connecting pipes

When it comes to pipe connections, the industry and OEMs rely on NORMACONNECT® – the reliable solution that can be used with all kinds of different requirements, pipe materials and outer pipe diameters.



Our solution for connecting – FGR

FGR pipe couplings are a compact, economical and reliable means for connecting plain-ended pipes. They are suitable for joining plastic and metal pipes and especially pipes made from stainless steel. They can be used in mechanical engineering and construction, shipbuilding, civil engineering and in hydro technology, water supply and water treatment.

Supply pipes as well as exhaust pipes for solid, liquid or gaseous media can be joined easily and safely in a very short period of time even in narrow spaces. Thanks to the wide range of various types and sizes they are suitable for use both in standard and specialized applications.

Product benefits

FGR pipe couplings are an economical alternative to conventional pipe joining techniques for both plastic and metal pipes. All plain-ended pipes can be joined easily by hand. The ready-to-fit coupling is pushed over the pipe ends and then aligned and rotated to any fitting position. Tightening the two bolts alternately with a torque wrench is all it takes to make a safe fitting.

Range of applications

FGR pipe coupling is a reliable connection for thick- and thin-walled pipes which conforms to the latest DIN Standard 86128. Feed and return lines for liquids, gases and solids (for mechanical engineering and construction, civil engineering, shipbuilding, pipeline construction, power stations, mining, filters, water technology, etc.) are joined quickly, easily and safely using FGR pipe couplings.

NORMA CONNECT®

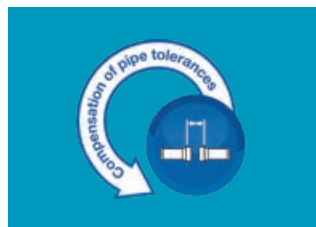
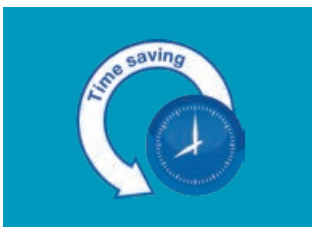

- No welding
- No necessity for prior pipe alignment or treatment of pipe ends
- Up to 80% time saving

- Compensates for pipe gaps up to 65 mm
- Compensates for axial movements up to 7.5 mm
- Compensates for misalignment up to 3 mm

- 70 % less weight

- Compensates for angular deflection up to + or - 2° in total

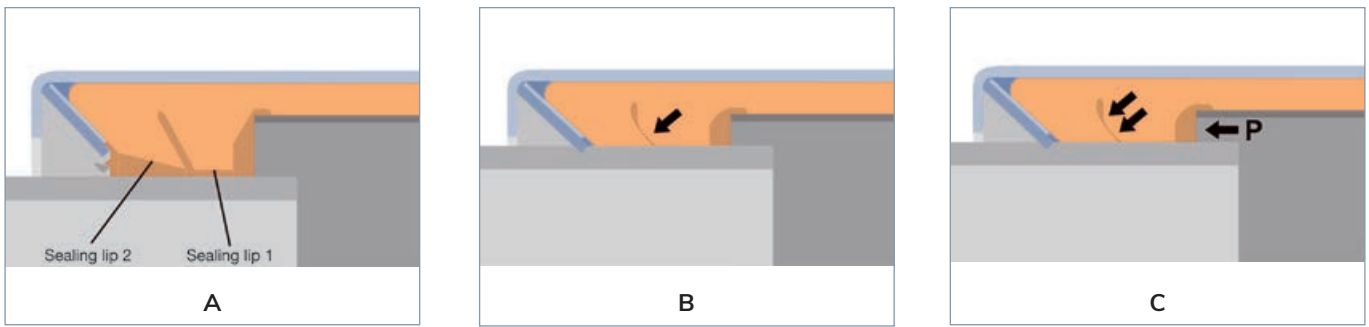

1. Double-lip sealing system

The patented double-lip sealing system of the FGR pipe couplings offers double safety. It provides maximum sealability at both low and high operating pressures (Fig. A).

When the bolts of the coupling are tightened, sealing lip 1 is pressed onto sealing lip 2, thus providing a highly reliable seal even under conditions of low pressure, vacuum or extreme loads acting on the joint (Fig. B).

The special sealing lip design means that when the internal pressure (P) increases, the sealing lips are pressed more firmly onto the pipe surface ensuring an even stronger seal (Fig. C).

2. Strip insert included as standard

All FGR pipe couplings are factory equipped with the strip insert as standard. The strip insert protects the sealing sleeve from increased mechanical and chemical loads. It also prevents the sealing sleeve from moisture expansion and allows larger gaps between the pipe ends to be connected.

Furthermore, it compensates for larger angular deflections and misalignment. With the strip insert the couplings can also be used for both vacuum and high pressure applications without any problems. The strip inserts are made from plastic material or stainless steel.

3. Heavy duty lock bars

For FGR pipe couplings we use lock bars with a larger diameter. Thus the rigidity of the coupling is increased and the engagement of the threaded end of the locking bolts is considerably improved.

4. Anchoring ring with conically stamped teeth







The anchoring ring with conically stamped teeth indents into the pipe surface and provides safe and strong axial restraint. Owing to the special design the coupling is able to withstand even high vibration loads.

5. Protection ring



The protection ring protects the sealing sleeve from UV rays, fire, etc., and increases the flexural strength of the coupling.





Approvals

Shipbuilding		FLEX / FLEX E / RFP	GRIP / GRIP E / Grip E-FP / RFP	CombiGrip / CombiGrip E	PlastGrip / PlastGrip E	Rep E
ABS		•	•	•	•	
Bureau Veritas		•	•	•	•	
DNV		•	•	•	•	
LR		• ¹	• ¹	•	•	
RINA		•	•			
MRS		•	•	•	•	
PRS		• ¹	• ¹			



Water supply & treatment

Elastomer guideline KTW/TZW W270		•	•	•	•	•
DVGW					• ²	
GOST		•	•	•	•	•
NSF		•	•	•	•	

GAS

DVGW / gwi			•			
BAM			•		•	

Special approvals

DIBT / TÜV south. Germany			•			
BAAINBW			• ³			
FDA		•	•	•	•	

¹ No approvals for RFP

² From 40.0 mm up to 160 mm

³ Approval for German Navy / NATO vessels

Pressure rating for axial non restraint pipe couplings type Flex

Pipes to be joined	Size (mm)	Flex	Flex E	Flex 3	REP E from 35 mm
Metal + Metal	26.9 to 168.3	70 to 32 bar	70 to 32 bar	-	60 to 32 bar
	180.0 to 1219.2	50 to 7 bar	30 to 4 bar	-	30 to 4 bar
	326.0 to 2032.0	-	-	16.5 to 1.5 bar	-
Plastic + Plastic	26.9 to 168.3	16 bar	16 bar	-	16 bar
	180.0 to 1219.2	16 to 4 bar	16 to 4 bar	-	16 to 4 bar
Metal + Plastic	26.9 to 168.3	16 bar	16 bar	-	-
	180.0 to 1219.2	16 to 7 bar	16 to 7 bar	-	-

Larger diameters available on request

Pressure rating for axial restraint pipe couplings type Grip

Pipes to be joined	Size (mm)	Grip	Grip E	Combi-Grip E	Combi-Grip	Plast-Grip E	Plast-Grip	Grip E-FP
Metal + Metal	26.9 to 168.3	70 to 32 bar	70 to 32 bar	-	-	-	-	60 to 32 bar
	180.0 to 419.0	-	20 to 2 bar	-	-	-	-	20 to 65 bar
	180.0 to 812.8	32 to 1 bar	-	-	-	-	-	-
Plastic + Plastic	40.0 to 168.3	-	-	-	-	16 bar	-	-
	200.0 to 406.4	-	-	-	-	-	16 to 6 bar	-
Metal + Plastic	38/40 to 160/168.3	16 bar	16 bar	16 bar	-	-	-	-
	200.0/204.0 to 406.0/406.4	-	-	-	16 to 6 bar	-	-	-

Larger diameters available on request

Sealing sleeves

Material of seal	EPDM	NBR	FKM
Temperature range	-30 °C up to +125 °C OD 26.9 up to 168.3 mm -20 °C up to +80 °C OD > 180 mm	-20 °C up to +80 °C	-10 °C to +150 °C*
Media	Drinking water Alcohols Compressed air Solids	Water Oils Gases (combustible) Fuels Hydrocarbons	Steam Several gases Hot water Ozone Oxygen Several acids** Several alkalis** Hydrocarbons

* Higher temperatures possible in some cases

** Case by case approval required. Please check with your sales representative

FGR Materials

Components and materials in accordance with AISI/BS. FGR pipe couplings are available in the materials W2, W4 and W5.

W2				
No.	Component	Flex/Flex E	Grip/Grip E	Plast Grip/ Plast Grip E
1	Housing with bridge	304/304 S31	304/304 S31	304/304 S31
2	Sealing sleeve	EPDM/NBR	EPDM/NBR	EPDM/NBR
3	Strip insert ¹⁾	316Ti/320 S31/PA-GR	316Ti/320 S31/PA-GR	316Ti/320 S31/PA-GR
4 A	Anchoring ring for metal pipes ²⁾	–	301/301 S21	–
4 A	Anchoring ring for plastic pipes ²⁾	–	–	PA-GF-NS ³⁾
4 B	Protection ring	316Ti/320 S31	–	–
5 + 6	Solid locking trunnions	AISI 1213	AISI 1213	AISI 1213
5 + 6	Hollow locking trunnions	AISI 1518	AISI 1518	AISI 1518
7	Locking bolts	10.9	10.9	10.9
8	Washer	A4-80/316	A4-80/316	A4-80/316

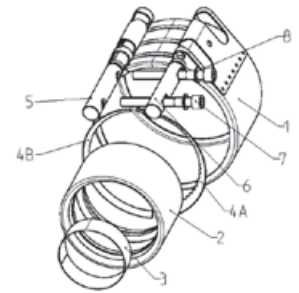

W4				
No.	Component	Flex/Flex E	Grip/Grip E	Plast Grip/ Plast Grip E
1	Housing with bridge	304/304 S31	304/304 S31	304/304 S31
2	Sealing sleeve	EPDM/NBR	EPDM/NBR	EPDM/NBR
3	Strip insert ¹⁾	316Ti/320 S31/PA-GR	316Ti/320 S31/PA-GR	316Ti/320 S31/PA-GR
4 A	Anchoring ring for metal pipes ²⁾	–	301/301 S21	–
4 A	Anchoring ring for plastic pipes ²⁾	–	–	PA-GF-NS ³⁾
4 B	Protection ring	316Ti/320 S31	316Ti/320 S31	–
5 + 6	Solid locking trunnions	316L	316L	316L
5 + 6	Hollow locking trunnions	316Ti/320 S31	316Ti/320 S31	316Ti/320 S31
7	Locking bolts	A4-80/316	A4-80/316	A4-80
8	Washer	A4-80/316	A4-80/316	A4-80

¹⁾ PA-GF plastic strip inserts are only for pipe couplings used in shipbuilding applications.

²⁾ COMBI GRIP couplings are equipped with two different anchoring rings (1 x for the metal end, 1 x for the plastic end).

³⁾ PA-GF: PA reinforced with fiber glass; NS: new silver.

W5						
No.	Component	Flex/Flex E	Grip/Grip E	Combi Grip/ Combi Grip E	Plast Grip/ Plast Grip E	Rep E
1	Housing	316Ti/320 S31	316Ti/320 S31	316Ti/320 S31	316Ti/320 S31	316Ti/320 S31
2	Sealing sleeve	EPDM/NBR/FKM	EPDM/NBR/FKM	EPDM/NBR	EPDM/NBR	EPDM/NBR
3	Strip insert ¹⁾	316Ti/320 S31/PA-GR	316Ti/320 S31/PA-GR	316Ti/320 S31/PA-GR	316Ti/320 S31/PA-GR	316Ti/320 S31/PA-GR
4 A	Anchoring ring for metal pipes ²⁾	–	301/301 S21	301/301 S21 301/301 S21	–	–
4 A	Anchoring ring for plastic pipes ²⁾	–	–	PA-GF-NS ³⁾	PA-GF-NS ³⁾	–
4 B	Protection ring	316Ti/320 S31	–	–	–	–
5 + 6	Solid locking trunnions	316L	316L	316L	316L	316L
5 + 6	Hollow locking trunnions	316Ti/320 S31	316Ti/320 S31	316Ti/320 S31	316Ti/320 S31	316Ti/320 S31
7	Locking bolts	A4-80/316	A4-80/316	A4-80/316	A4-80/316	A4-80/316
8	Washer	A4-80/316	A4-80/316	A4-80/316	A4-80/316	A4-80/316

¹⁾ PA-GF plastic strip inserts are only for pipe couplings used in shipbuilding applications.

²⁾ COMBI GRIP couplings are equipped with two different anchoring rings (1 x for the metal end, 1 x for the plastic end).

³⁾ PA-GF: PA reinforced with fiber glass; NS: nickel and silver.

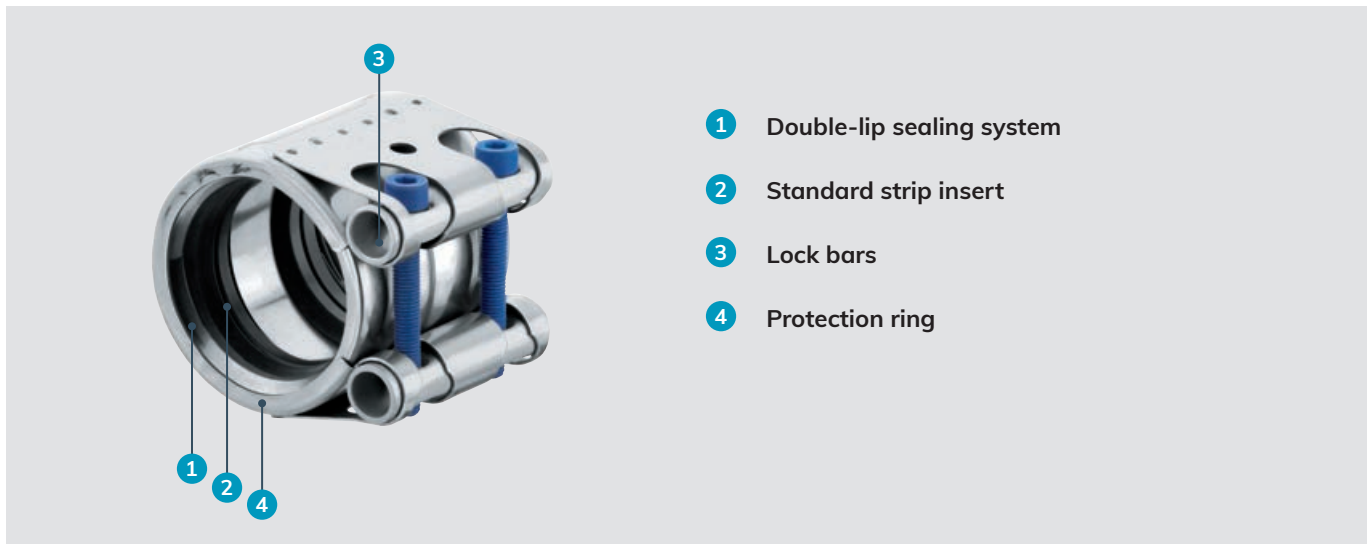

The protective pipe coupling

NORMACONNECT® FLEX /FLEX E are axial non-restraint couplings. They are used for all kind of metal pipes, as well as pipes made of concrete or plastic. Sealing reliability is ensured even when NORMACONNECT® FLEX /FLEX E pipe couplings are mounted on pipes with or without a gap and also on compensated pipes.



NORMACONNECT®

Advantages at a glance

- ✓ Compensates for thermal elongation of the pipes
- ✓ Joining all kind of pipe materials is possible, e.g., for steel, plastic, cast iron, etc.

Information

- Sizes: 26.9 mm –1219.1 mm
- Working pressure: 70.0 – 4.0 bar
- Material: AISI 304, AISI 316 Ti
- EPDM:
 - Sizes from 26.9 mm up to 168.3 mm: -30 °C up to +125 °C
 - Sizes > 180.0 mm: -20 °C up to +80 °C
- NBR: from -20 °C up to +80 °C
- FKM: -10 °C to +150 °C
(Higher temperatures possible in some cases.)



Materials

W1	W2	W3	W4	W5
	x		x	x

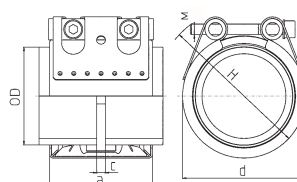
Technical data & Ordering information



Technical data & Ordering information

NORMACONNECT® FGR FLEX E											
Ø (O.D.)	Designation	Clamping ranges Oadmin - Odmax (mm)	PN ¹ (MAWP ¹ from diameter 180)	WP ²	C max (mm)	Dimensions (approx.)			Weight (approx.) (kg/pc.)	Hex socket locking bolts	
			 [bar]	 [bar]		a (mm)	d (mm)	H (mm)		Thread	Tightening torque (Nm)
26.9	Flex E 26.9	26.4-27.5	16	70	3	67	50	70	0.31	M 8 SW 6	5
28.0	Flex E 28.0	27.5-28.5	16	70	3	67	50	70	0.31	M 8 SW 6	5
30.0	Flex E 30.0	29.5-30.6	16	70	3	67	50	70	0.31	M 8 SW 6	5
33.7	Flex E 33.7	33.0-34.3	16	60	3	67	55	75	0.32	M 8 SW 6	5
35.0	Flex E 35.0	34.5-35.6	16	60	8	63	55	75	0.43	M 8 SW 6	5
38.0	Flex E 38.0	37.5-38.6	16	60	8	63	60	80	0.43	M 8 SW 6	5
42.4	Flex E 42.4	41.7-43.0	16	50	8	63	65	85	0.44	M 8 SW 6	5
44.5	Flex E 44.5	44.0-45.1	16	50	8	63	65	85	0.45	M 8 SW 6	5
48.3	Flex E 48.3	47.6-50.5	16	50	8	63	70	90	0.46	M 8 SW 6	5
54.0	Flex E 54.0	53.3-54.6	16	50	17	78	75	95	0.60	M 8 SW 6	10
57.0	Flex E 57.0	56.3-57.7	16	50	17	78	80	100	0.61	M 8 SW 6	10
60.3	Flex E 60.3	59.5-61.0	16	40	17	78	85	105	0.62	M 8 SW 6	10
63.0	FLEX E 63.0	62.2-63.9	16	40	17	78	85	105	0.62	M 8 SW 6	10
70.0	Flex E 70.0	69.0-71.0	16	40	25	98	90	110	1.16	M 8 SW 6	10
73.0	Flex E 73.0	72.1-73.8	16	40	25	98	95	115	1.18	M 8 SW 6	10
76.1	Flex E 76.1	75.2-77.0	16	35	25	98	100	120	1.18	M 8 SW 6	10
80.0	Flex E 80.0	79.0-80.8	16	35	25	98	100	120	1.21	M 8 SW 6	10
84.0	Flex E 84.0	83.0-85.0	16	35	25	98	105	125	1.24	M 8 SW 6	10
88.9	Flex E 88.9	87.0-89.9	16	35	25	98	110	130	1.26	M 8 SW 6	10
101.6	Flex E 101.6	100.4-102.8	16	35	25	98	125	145	1.39	M 8 SW 6	10
104.0	Flex E 104.0	102.8-106.1	16	35	25	98	125	145	1.40	M 8 SW 6	10
108.0	Flex E 108.0	106.8-109.2	16	35	25	98	130	150	1.42	M 8 SW 6	10
110.0	Flex E 110.0	108.8-111.4	16	35	25	98	130	150	1.47	M 8 SW 6	10
114.3	Flex E 114.3	113.0-115.5	16	35	25	98	135	155	1.47	M 8 SW 6	15
129.0	Flex E 129.0	127.6-131.1	16	32	35	113	155	185	2.10	M 10 SW 8	20
133.0	Flex E 133.0	131.5-134.4	16	32	35	113	160	190	2.13	M 10 SW 8	20
139.7	Flex E 139.7	138.1-141.6	16	32	35	113	165	195	2.19	M 10 SW 8	25
141.3	Flex E 141.3	139.6-142.8	16	32	35	113	170	200	2.19	M 10 SW 8	25
154.0	Flex E 154.0	152.3-156.1	16	32	35	113	180	210	2.31	M 10 SW 8	30
159.0	Flex E 159.0	157.3-160.7	16	32	35	113	185	215	2.38	M 10 SW 8	30
168.3	Flex E 168.3	166.5-170.1	16	32	35	113	195	225	2.43	M 10 SW 8	30

PN¹ (Nominal Pressure) is the max. admissible working pressure in shipbuilding, based on a safety factor of ≥ 4.
 MAWP¹ (Maximum Allowable Working Pressure) is the max. admissible working pressure in shipbuilding, based on a safety factor of ≥ 4.
 WP² is the max. working pressure in industrial applications, with a safety factor as per NORMA specification.

NORMACONNECT®

Technical data & Ordering information



NORMACONNECT® FGR FLEX E								
Ø (O.D.)	Designation	W2 Product No.		W4 Product No.		W5 Product No.		
		EPDM	NBR	EPDM	NBR	EPDM	NBR	FKM
26.9	Flex E 26.9	0582 9100 026	0582 8400 026	0582 9200 026	0582 8500 026	0582 9300 026	0582 8600 026	
28.0	Flex E 28.0	0582 9100 028	0582 8400 028	0582 9200 028	0582 8500 028	0582 9300 028	0582 8600 028	
30.0	Flex E 30.0	0582 9100 030	0582 8400 030	0582 9200 030	0582 8500 030	0582 9300 030	0582 8600 030	
33.7	Flex E 33.7	0582 9100 033	0582 8400 033	0582 9200 033	0582 8500 033	0582 9300 033	0582 8600 033	0582 9900 033
35.0	Flex E 35.0	0582 9100 035	0582 8400 035	0582 9200 035	0582 8500 035	0582 9300 035	0582 8600 035	
38.0	Flex E 38.0	0582 9100 038	0582 8400 038	0582 9200 038	0582 8500 038	0582 9300 038	0582 8600 038	0582 9900 038
42.4	Flex E 42.4	0582 9100 042	0582 8400 042	0582 9200 042	0582 8500 042	0582 9300 042	0582 8600 042	0582 9900 042
44.5	Flex E 44.5	0582 9100 044	0582 8400 044	0582 9200 044	0582 8500 044	0582 9300 044	0582 8600 044	
48.3	Flex E 48.3	0582 9100 048	0582 8400 048	0582 9200 048	0582 8500 048	0582 9300 048	0582 8600 048	0582 9900 048
54.0	Flex E 54.0	0582 9100 054	0582 8400 054	0582 9200 054	0582 8500 054	0582 9300 054	0582 8600 054	
57.0	Flex E 57.0	0582 9100 057	0582 8400 057	0582 9200 057	0582 8500 057	0582 9300 057	0582 8600 057	0582 9900 057
60.3	Flex E 60.3	0582 9100 060	0582 8400 060	0582 9200 060	0582 8500 060	0582 9300 060	0582 8600 060	0582 9900 060
63.0	FLEX E 63.0	0582 9100 063	0582 8400 063	0582 9200 063	0582 8500 063	0582 9300 063	0582 8600 063	0582 9900 063
70.0	Flex E 70.0	0582 9100 070	0582 8400 070	0582 9200 070	0582 8500 070	0582 9300 070	0582 8600 070	
73.0	Flex E 73.0	0582 9100 073	0582 8400 073	0582 9200 073	0582 8500 073	0582 9300 073	0582 8600 073	
76.1	Flex E 76.1	0582 9100 076	0582 8400 076	0582 9200 076	0582 8500 076	0582 9300 076	0582 8600 076	0582 9900 076
80.0	Flex E 80.0	0582 9100 080	0582 8400 080	0582 9200 080	0582 8500 080	0582 9300 080	0582 8600 080	
84.0	Flex E 84.0	0582 9100 084	0582 8400 084	0582 9200 084	0582 8500 084	0582 9300 084	0582 8600 084	
88.9	Flex E 88.9	0582 9100 088	0582 8400 088	0582 9200 088	0582 8500 088	0582 9300 088	0582 8600 088	0582 9900 088
101.6	Flex E 101.6	0582 9100 101	0582 8400 101	0582 9200 101	0582 8500 101	0582 9300 101	0582 8600 101	
104.0	Flex E 104.0	0582 9100 104	0582 8400 104	0582 9200 104	0582 8500 104	0582 9300 104	0582 8600 104	
108.0	Flex E 108.0	0582 9100 108	0582 8400 108	0582 9200 108	0582 8500 108	0582 9300 108	0582 8600 108	
110.0	Flex E 110.0	0582 9100 110	0582 8400 110	0582 9200 110	0582 8500 110	0582 9300 110	0582 8600 110	
114.3	Flex E 114.3	0582 9100 114	0582 8400 114	0582 9200 114	0582 8500 114	0582 9300 114	0582 8600 114	0582 9900 114
129.0	Flex E 129.0	0582 9100 129	0582 8400 129	0582 9200 129	0582 8500 129	0582 9300 129	0582 8600 129	0582 9900 129
133.0	Flex E 133.0	0582 9100 133	0582 8400 133	0582 9200 133	0582 8500 133	0582 9300 133	0582 8600 133	
139.7	Flex E 139.7	0582 9100 139	0582 8400 139	0582 9200 139	0582 8500 139	0582 9300 139	0582 8600 139	0582 9900 139
141.3	Flex E 141.3	0582 9100 141	0582 8400 141	0582 9200 141	0582 8500 141	0582 9300 141	0582 8600 141	
154.0	Flex E 154.0	0582 9100 154	0582 8400 154	0582 9200 154	0582 8500 154	0582 9300 154	0582 8600 154	
159.0	Flex E 159.0	0582 9100 159	0582 8400 159	0582 9200 159	0582 8500 159	0582 9300 159	0582 8600 159	
168.3	Flex E 168.3	0582 9100 168	0582 8400 168	0582 9200 168	0582 8500 168	0582 9300 168	0582 8600 168	0582 9900 168



NORMACONNECT® FLEX is an axial non-restraint coupling. It is used for connecting metal pipes, stainless pipes, as well as concrete and plastic pipes. This is a full trunnions version.

Material

W2, W4, W5

NORMACONNECT® FGR FLEX											
Ø (O.D.)	Designation	Clamping ranges	PN ¹ (MAWP ¹ from Ø 180)	WP ²	C max	Dimensions (approx.)			Weight (approx.)	Hex socket locking bolts	
		O _{dmin} - O _{dmax} (mm)	 [bar]	 [bar]	(mm)	a (mm)	d (mm)	H (mm)	(kg/pc.)	Thread	Tightening torque (Nm)
180.0	Flex 180.0	178.0 - 182.0	16.0	50.0	35	141	210	240	5.4	M 12 SW 10	35
193.7	Flex 193.7	192.0 - 196.0	16.0	46.0	35	141	225	255	5.6	M 12 SW 10	35
206.0	Flex 206.0	202.0 - 208.0	16.0	43.0	35	141	240	270	5.8	M 12 SW 10	35
219.0	Flex 219.0	216.0 - 221.0	16.0	40.5	35	141	250	280	6.0	M 12 SW 10	35
225.0	Flex 225.0	222.0 - 227.0	16.0	40.0	35	141	255	285	6.1	M 12 SW 10	35
229.9	Flex 229.9	228.0 - 232.0	16.0	39.0	35	141	260	290	6.2	M 12 SW 10	35
244.5	Flex 244.5	242.0 - 247.0	16.0	37.0	35	141	275	305	6.4	M 12 SW 10	35
254.0	Flex 254.0	250.0 - 256.0	16.0	35.5	35	141	285	315	6.5	M 12 SW 10	35
267.0	Flex 267.0	264.0 - 269.0	16.0	33.5	35	141	300	330	6.7	M 12 SW 10	35
273.0	Flex 273.0	270.0 - 275.0	16.0	33.0	35	141	305	335	6.8	M 12 SW 10	35
306.0	Flex 306.0	302.0 - 308.0	15.0	29.0	35	141	340	370	7.4	M 12 SW 10	35
323.9	Flex 323.9	320.0 - 327.0	15.0	28.0	35	141	355	385	7.6	M 12 SW 10	35
326.0	Flex 326.0	322.0 - 329.0	13.0	27.5	35	141	360	390	7.7	M 12 SW 10	35
355.6	Flex 355.6	352.0 - 359.0	13.0	25.0	35	141	390	420	8.1	M 12 SW 10	35
406.4	Flex 406.4	402.0 - 410.0	10.0	22.0	35	141	440	470	8.9	M 12 SW 10	35
429.0	Flex 429.0	426.0 - 431.0	7.5	21.0	35	141	460	490	9.3	M 12 SW 10	40
442.0	Flex 442.0	439.0 - 444.0	7.5	20.0	35	141	475	505	9.5	M 12 SW 10	40
457.2	Flex 457.2	454.0 - 459.0	7.5	19.5	35	141	490	520	9.7	M 12 SW 10	40
508.0	Flex 508.0	505.0 - 510.0	7.5	17.0	35	141	540	570	10.5	M 12 SW 10	40
531.0	Flex 531.0	528.0 - 534.0	7.5	16.0	35	141	565	595	10.9	M 12 SW 10	50
558.8	Flex 558.8	556.0 - 562.0	7.5	15.5	35	141	590	620	11.3	M 12 SW 10	50
609.6	Flex 609.6	606.0 - 613.0	6.0	14.0	35	141	640	670	12.1	M 12 SW 10	50
634.0	Flex 634.0	631.0 - 637.0	5.0	13.5	35	141	665	695	12.5	M 12 SW 10	50
711.2	Flex 711.2	707.0 - 715.0	5.0	12.0	35	141	745	775	13.7	M 12 SW 10	50
762.0	Flex 762.0	758.0 - 766.0	4.5	11.0	35	141	795	885	14.5	M 12 SW 10	50
812.8	Flex 812.8	808.0 - 817.0	4.5	10.5	35	141	845	935	17.2	M 12 SW 10	50
914.4	Flex 914.4	909.0 - 919.0	3.3	9.5	35	141	945	1035	18.8	M 12 SW 10	60
1016.0	Flex 1016.0	1013.0 - 1019.0	3.3	8.0	35	141	1050	1140	20.4	M 12 SW 10	60
1117.5	Flex 1117.5	1114.0 - 1120.0	3.3	7.5	35	141	1150	1240	22.0	M 12 SW 10	60
1219.2	Flex 1219.2	1216.0 - 1222.0	3.3	7.0	35	141	1250	1340	23.6	M 12 SW 10	60

PN¹ (Nominal Pressure) is the max. admissible working pressure in shipbuilding, based on a safety factor of ≥ 4.
 MAWP¹ (Maximum Allowable Working Pressure) is the max. admissible working pressure in shipbuilding, based on a safety factor of ≥ 4.
 WP² is the max. working pressure in industrial applications, with a safety factor as per NORMA specification.

Technical data & Ordering information

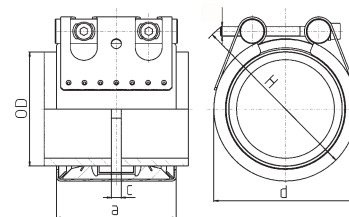

NORMACONNECT® FGR FLEX							
Ø (O.D.)	Designation	W2 Product No.		W4 Product No.		W5 Product No.	
		EPDM	NBR	EPDM	NBR	EPDM	NBR
180.0	Flex 180.0	0575 8140 180	0575 8440 180	0575 8240 180	0575 8540 180	0575 8340 180	0575 8640 180
193.7	Flex 193.7	0575 8140 193	0575 8440 193	0575 8240 193	0575 8540 193	0575 8340 193	0575 8640 193
206.0	Flex 206.0	0575 8140 206	0575 8440 206	0575 8240 206	0575 8540 206	0575 8340 206	0575 8640 206
219.0	Flex 219.0	0575 8140 219	0575 8440 219	0575 8240 219	0575 8540 219	0575 8340 219	0575 8640 219
225.0	Flex 225.0	0575 8140 225	0575 8440 225	0575 8240 225	0575 8540 225	0575 8340 225	0575 8640 225
229.9	Flex 229.9	0575 8140 229	0575 8440 229	0575 8240 229	0575 8540 229	0575 8340 229	0575 8640 229
244.5	Flex 244.5	0575 8140 244	0575 8440 244	0575 8240 244	0575 8540 244	0575 8340 244	0575 8640 244
254.0	Flex 254.0	0575 8140 254	0575 8440 254	0575 8240 254	0575 8540 254	0575 8340 254	0575 8640 254
267.0	Flex 267.0	0575 8140 267	0575 8440 267	0575 8240 267	0575 8540 267	0575 8340 267	0575 8640 267
273.0	Flex 273.0	0575 8140 273	0575 8440 273	0575 8240 273	0575 8540 273	0575 8340 273	0575 8640 273
306.0	Flex 306.0	0575 8140 306	0575 8440 306	0575 8240 306	0575 8540 306	0575 8340 306	0575 8640 306
323.9	Flex 323.9	0575 8140 323	0575 8440 323	0575 8240 323	0575 8540 323	0575 8340 323	0575 8640 323
326.0	Flex 326.0	0575 8140 326	0575 8440 326	0575 8240 326	0575 8540 326	0575 8340 326	0575 8640 326
355.6	Flex 355.6	0575 8140 355	0575 8440 355	0575 8240 355	0575 8540 355	0575 8340 355	0575 8640 355
406.4	Flex 406.4	0575 8140 406	0575 8440 406	0575 8240 406	0575 8540 406	0575 8340 406	0575 8640 406
429.0	Flex 429.0	0575 8140 429	0575 8440 429	0575 8240 429	0575 8540 429	0575 8340 429	0575 8640 429
442.0	Flex 442.0	0575 8140 442	0575 8440 442	0575 8240 442	0575 8540 442	0575 8340 442	0575 8640 442
457.2	Flex 457.2	0575 8140 457	0575 8440 457	0575 8240 457	0575 8540 457	0575 8340 457	0575 8640 457
508.0	Flex 508.0	0575 8140 508	0575 8440 508	0575 8240 508	0575 8540 508	0575 8340 508	0575 8640 508
531.0	Flex 531.0	0575 8140 531	0575 8440 531	0575 8240 531	0575 8540 531	0575 8340 531	0575 8640 531
558.8	Flex 558.8	0575 8140 558	0575 8440 558	0575 8240 558	0575 8540 558	0575 8340 558	0575 8640 558
609.6	Flex 609.6	0575 8140 609	0575 8440 609	0575 8240 609	0575 8540 609	0575 8340 609	0575 8640 609
634.0	Flex 634.0	0575 8140 634	0575 8440 634	0575 8240 634	0575 8540 634	0575 8340 634	0575 8640 634
711.2	Flex 711.2	0575 8140 711	0575 8440 711	0575 8240 711	0575 8540 711	0575 8340 711	0575 8640 711
762.0	Flex 762.0	0575 8140 762	0575 8440 762	0575 8240 762	0575 8540 762	0575 8340 762	0575 8640 762
812.8	Flex 812.8	0575 8140 812	0575 8440 812	0575 8240 812	0575 8540 812	0575 8340 812	0575 8640 812
914.4	Flex 914.4	0575 8140 914	0575 8440 914	0575 8240 914	0575 8540 914	0575 8340 914	0575 8640 914
1016.0	Flex 1016.0	0575 8141 016	0575 8441 016	0575 8241 016	0575 8541 016	0575 8341 016	0575 8641 016
1117.5	Flex 1117.5	0575 8141 117	0575 8441 117	0575 8241 117	0575 8541 117	0575 8341 117	0575 8641 117
1219.2	Flex 1219.2	0575 8141 219	0575 8441 219	0575 8241 219	0575 8541 219	0575 8341 219	0575 8641 219

NORMACONNECT®

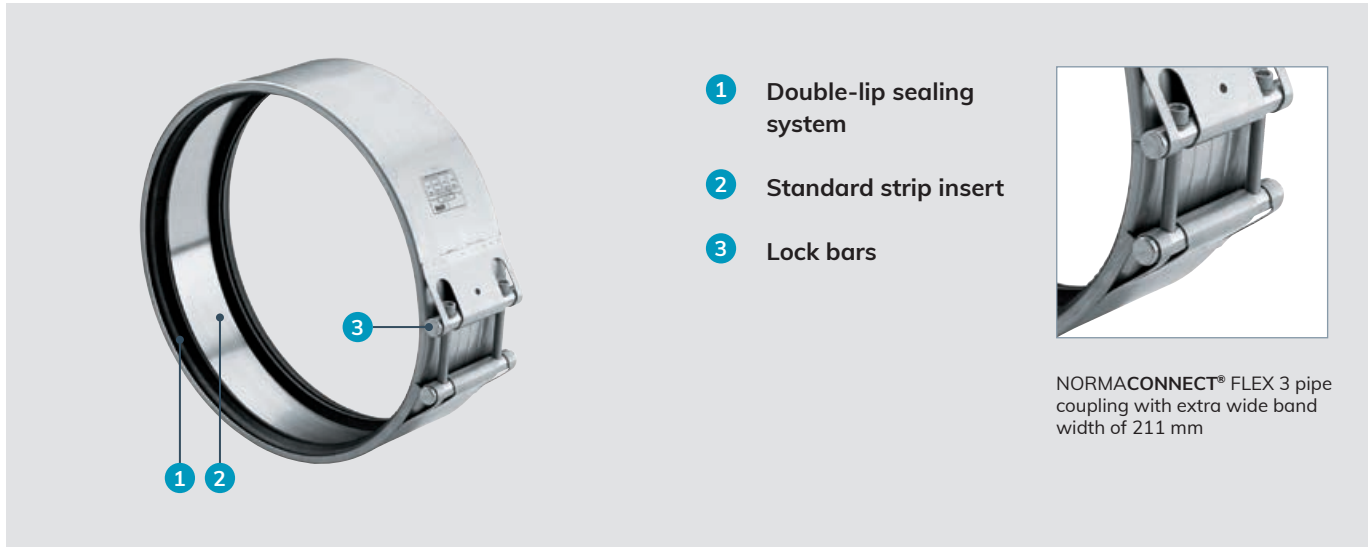

- 1 Double-lip sealing system
- 2 Standard strip insert
- 3 Lock bars



NORMACONNECT® FLEX 3 pipe coupling with extra wide band width of 211 mm

The pipe coupling with extra wide band

NORMACONNECT® FLEX 3 featuring an extra wide band is an axial non-restraint coupling used to connect metal and/or plastic pipes quickly and safely.



Advantages at a glance

- ✓ Easy and quick to assemble
- ✓ Pipe end distance up to 65 mm possible
- ✓ Compensation of misalignment, angular deflection up to 4° possible

Information

- Sizes: from 812.8 mm to 2032.0 mm
- Working pressure: 6.5 bar – 1.5 bar
- Solid trunnions
- 2 closure units
- Material: AISI 316 Ti
- EPDM: from -20 °C up to +80 °C
- NBR: from -20 °C up to +80 °C

Materials

W1	W2	W3	W4	W5
				x

Technical data & Ordering information

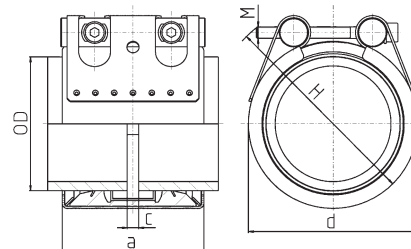

Technical data & Ordering information

NORMACONNECT® FGR FLEX 3												
Ø (O.D.)	Designation	Clamping ranges	WP ¹	C max	Dimensions (approx.)			Weight (approx.)	Hex socket locking bolts		W5 Product No.	
			 [bar]	(mm)	a (mm)	d (mm)	H (mm)	(kg/pc.)	Thread	Tightening torque (Nm)	EPDM	NBR
812.8	Flex 3 812.8	808.0 - 817.0	6.5	65	211	850	890	21.4	M 16 SW 14	45	0571 8330 812	0571 8630 812
914.4	Flex 3 914.4	909.0 - 919.0	6.0	65	211	950	990	23.4	M 16 SW 14	45	0571 8330 914	0571 8630 914
1016.0	Flex 3 1016.0	1013.0 - 1019.0	5.0	65	211	1055	1095	25.4	M 16 SW 14	50	0571 8331 016	0571 8631 016
1117.5	Flex 3 1117.5	1114.0 - 1120.0	4.5	65	211	1155	1195	27.4	M 16 SW 14	50	0571 8331 117	0571 8631 117
1219.2	Flex 3 1219.2	1216.0 - 1222.0	4.0	65	211	1255	1295	29.4	M 16 SW 14	55	0571 8331 219	0571 8631 219
1320.8	Flex 3 1320.8	1314.0 - 1328.0	3.0	65	211	1360	1400	31.4	M 16 SW 14	55	0571 8331 320	0571 8631 320
1422.4	Flex 3 1422.4	1415.0 - 1430.0	3.0	65	211	1460	1500	33.4	M 16 SW 14	60	0571 8331 422	0571 8631 422
1524.0	Flex 3 1524.0	1516.0 - 1532.0	2.5	65	211	1560	1600	35.4	M 16 SW 14	60	0571 8331 524	0571 8631 524
1625.6	Flex 3 1625.6	1617.0 - 1634.0	2.5	65	211	1665	1705	37.4	M 16 SW 14	70	0571 8331 625	0571 8631 625
1727.2	Flex 3 1727.2	1718.0 - 1736.0	2.0	65	211	1765	1805	39.4	M 16 SW 14	70	0571 8331 727	0571 8631 727
1828.8	Flex 3 1828.8	1819.0 - 1838.0	2.0	65	211	1865	1905	41.4	M 16 SW 14	80	0571 8331 828	0571 8631 828
1930.4	Flex 3 1930.4	1320.0 - 1940.0	2.0	65	211	1970	2010	43.4	M 16 SW 14	80	0571 8331 930	0571 8631 930
2032.0	Flex 3 2032.0	2021.0 - 2042.0	1.5	65	211	2070	2110	45.4	M 16 SW 14	80	0571 8332 032	0571 8632 032

WP¹ is the max. working pressure in industrial applications, with a safety factor as per NORMA specification.

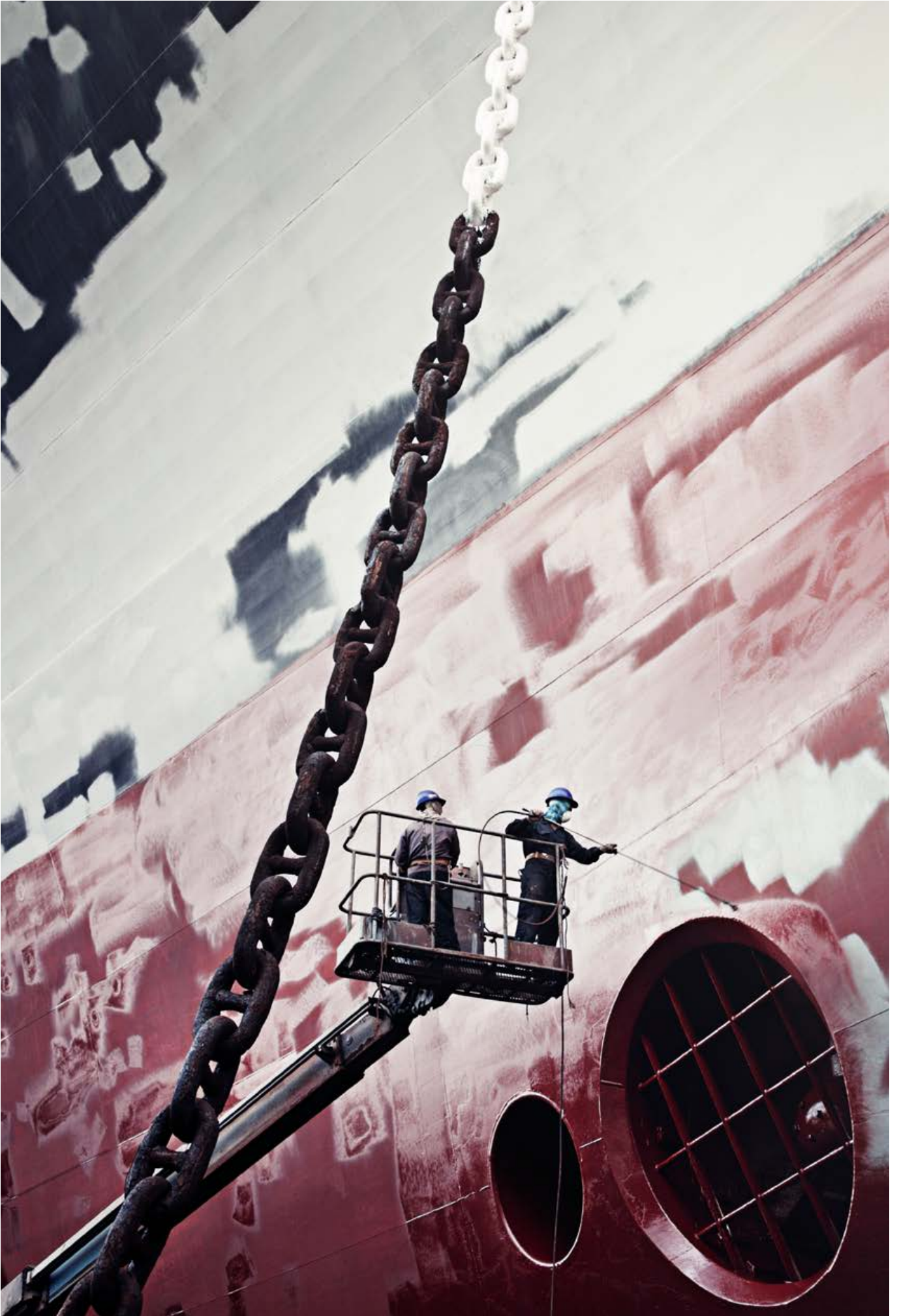

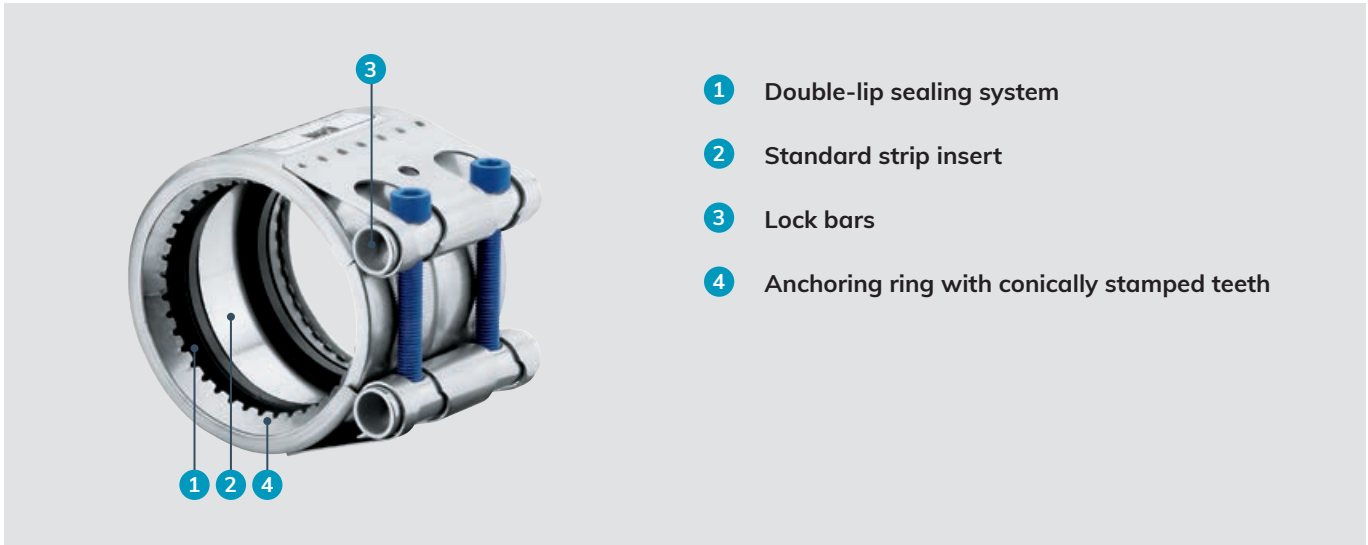

- 1 Double-lip sealing system
- 2 Standard strip insert
- 3 Lock bars
- 4 Anchoring ring with conically stamped teeth

The strong pipe coupling

NORMACONNECT® GRIP/GRIP E axial restraint pipe couplings are used to connect metal pipes. The anchoring ring with conically stamped teeth indents into the pipe surface (steel, stainless steel or cast iron) and provides safe and strong axial restraint. Owing to the special design, the coupling can withstand even high vibration loads.

Advantages at a glance

- ✓ Progressive locking effect ensures a trouble- and maintenance-free connection
- ✓ Reusable
- ✓ Shock resistant
- ✓ Space saving connector
- ✓ Withstand high vibration loads

Information

- Sizes: 26.9 mm – 812.8 mm
- Working pressure: 70.0 bar – 1 bar
- Material: AISI 304, AISI 316 Ti
- EPDM:
 - Sizes from 26.9 mm up to 168.3 mm: -30 °C up to +125 °C
 - Sizes > 180.0 mm: from -20 °C up to +80 °C
- NBR: from -20 °C up to +80 °C
- FKM: -10 °C to +150 °C
(Higher temperatures possible in some cases.)



Materials

W1	W2	W3	W4	W5
	x		x	x

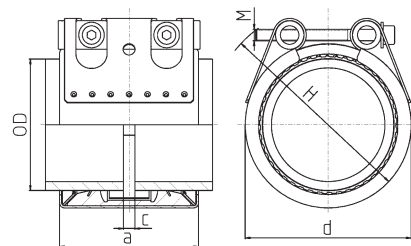
Technical data & Ordering information



Technical data & Ordering information

NORMACONNECT® FGR GRIP E											
Ø (O.D.)	Designation	Clamping ranges	PN ¹	WP ²	C max	Dimensions (approx.)			Weight (approx.)	Hex socket locking bolts	
		Odmin - Odmax (mm)	 [bar]	 [bar]	(mm)	a (mm)	d (mm)	H (mm)	(kg/pc.)	Thread	Tightening torque (Nm)
26.9	Grip E 26.9	26.4 - 27.5	16	70	3	67	50	70	0.32	M 8 SW 6	10
28.0	Grip E 28.0	27.5 - 28.5	16	70	3	67	50	70	0.32	M 8 SW 6	10
30.0	Grip E 30.0	29.5 - 30.6	16	70	3	67	50	70	0.32	M 8 SW 6	10
33.7	Grip E 33.7	33.0 - 34.3	16	60	3	67	55	75	0.33	M 8 SW 6	10
35.0	Grip E 35.0	34.5 - 35.6	16	60	8	63	55	75	0.45	M 8 SW 6	15
38.0	Grip E 38.0	37.5 - 38.6	16	60	8	63	60	80	0.45	M 8 SW 6	15
42.4	Grip E 42.4	41.7 - 43.0	16	50	8	63	65	85	0.46	M 8 SW 6	15
44.5	Grip E 44.5	44.0 - 45.1	16	50	8	63	65	85	0.47	M 8 SW 6	15
48.3	Grip E 48.3	47.6 - 50.5	16	50	8	63	70	90	0.48	M 8 SW 6	15
54.0	Grip E 54.0	53.3 - 54.6	16	50	17	78	75	95	0.62	M 8 SW 6	15
57.0	Grip E 57.0	56.3 - 57.7	16	50	17	78	80	100	0.63	M 8 SW 6	20
60.3	Grip E 60.3	59.5 - 61.0	16	40	17	78	85	105	0.64	M 8 SW 6	20
70.0	Grip E 70.0	69.0 - 71.0	16	40	25	98	90	110	1.21	M 10 SW 8	30
73.0	Grip E 73.0	72.1 - 73.8	16	40	25	98	95	115	1.23	M 10 SW 8	30
76.1	Grip E 76.1	75.2 - 77.0	16	35	25	98	100	120	1.23	M 10 SW 8	30
80.0	Grip E 80.0	79.0 - 80.8	16	35	25	98	100	120	1.27	M 10 SW 8	30
84.0	Grip E 84.0	83.0 - 85.0	16	35	25	98	105	125	1.29	M 10 SW 8	30
88.9	Grip E 88.9	87.0 - 89.9	16	35	25	98	110	130	1.31	M 10 SW 8	30
101.6	Grip E 101.6	100.4 - 102.8	16	35	25	98	125	145	1.45	M 10 SW 8	30
104.0	Grip E 104.0	102.8 - 106.1	16	35	25	98	125	145	1.46	M 10 SW 8	30
108.0	Grip E 108.0	106.8 - 109.2	16	35	25	98	130	150	1.49	M 10 SW 8	30
110.0	Grip E 110.0	108.8 - 111.4	16	35	25	98	130	150	1.54	M 10 SW 8	30
114.3	Grip E 114.3	113.0 - 115.5	16	35	25	98	135	155	1.54	M 10 SW 8	50
129.0	Grip E 129.0	127.6 - 131.1	16	32	35	115	155	185	2.83	M 12 SW 10	50
133.0	Grip E 133.0	131.5 - 134.4	16	32	35	115	160	190	2.93	M 12 SW 10	50
139.7	Grip E 139.7	138.1 - 141.6	16	32	35	115	165	195	3.04	M 12 SW 10	50
141.3	Grip E 141.3	139.6 - 142.8	16	32	35	115	170	200	3.04	M 12 SW 10	50
154.0	Grip E 154.0	152.3 - 156.1	16	32	35	115	180	210	3.17	M 12 SW 10	60
159.0	Grip E 159.0	157.3 - 160.7	16	32	35	115	185	215	3.28	M 12 SW 10	60
168.3	Grip E 168.3	166.5 - 170.1	16	32	35	115	195	225	3.35	M 12 SW 10	60

PN¹ (Nominal Pressure) is the max. admissible working pressure in shipbuilding, based on a safety factor of ≥ 4 .
 WP² is the max. working pressure in industrial applications, with a safety factor as per NORMA specification.

Technical data & Ordering information

NORMACONNECT® FGR GRIP E								
Ø (O.D.)	Designation	W2 Product No.		W4 Product No.		W5 Product No.		
		EPDM	NBR	EPDM	NBR	EPDM	NBR	FKM
26.9	Grip E 26.9	0579 9100 026	0579 8400 026	0579 9200 026	0579 8500 026	0579 9300 026	0579 8600 026	
28.0	Grip E 28.0	0579 9100 028	0579 8400 028	0579 9200 028	0579 8500 028	0579 9300 028	0579 8600 028	
30.0	Grip E 30.0	0579 9100 030	0579 8400 030	0579 9200 030	0579 8500 030	0579 9300 030	0579 8600 030	
33.7	Grip E 33.7	0579 9100 033	0579 8400 033	0579 9200 033	0579 8500 033	0579 9300 033	0579 8600 033	0579 9900 033
35.0	Grip E 35.0	0579 9100 035	0579 8400 035	0579 9200 035	0579 8500 035	0579 9300 035	0579 8600 035	
38.0	Grip E 38.0	0579 9100 038	0579 8400 038	0579 9200 038	0579 8500 038	0579 9300 038	0579 8600 038	0579 9900 038
42.4	Grip E 42.4	0579 9100 042	0579 8400 042	0579 9200 042	0579 8500 042	0579 9300 042	0579 8600 042	0579 9900 042
44.5	Grip E 44.5	0579 9100 044	0579 8400 044	0579 9200 044	0579 8500 044	0579 9300 044	0579 8600 044	
48.3	Grip E 48.3	0579 9100 048	0579 8400 048	0579 9200 048	0579 8500 048	0579 9300 048	0579 8600 048	0579 9900 048
54.0	Grip E 54.0	0579 9100 054	0579 8400 054	0579 9200 054	0579 8500 054	0579 9300 054	0579 8600 054	
57.0	Grip E 57.0	0579 9100 057	0579 8400 057	0579 9200 057	0579 8500 057	0579 9300 057	0579 8600 057	0579 9900 057
60.3	Grip E 60.3	0579 9100 060	0579 8400 060	0579 9200 060	0579 8500 060	0579 9300 060	0579 8600 060	0579 9900 060
63.0	Grip E 63.0	0579 9100 063	0579 8400 063	0579 9200 063	0579 8500 063	0579 9300 063	0579 8600 063	0579 9900 063
70.0	Grip E 70.0	0579 9100 070	0579 8400 070	0579 9200 070	0579 8500 070	0579 9300 070	0579 8600 070	
73.0	Grip E 73.0	0579 9100 073	0579 8400 073	0579 9200 073	0579 8500 073	0579 9300 073	0579 8600 073	
76.1	Grip E 76.1	0579 9100 076	0579 8400 076	0579 9200 076	0579 8500 076	0579 9300 076	0579 8600 076	0579 9900 076
80.0	Grip E 80.0	0579 9100 080	0579 8400 080	0579 9200 080	0579 8500 080	0579 9300 080	0579 8600 080	
84.0	Grip E 84.0	0579 9100 084	0579 8400 084	0579 9200 084	0579 8500 084	0579 9300 084	0579 8600 084	
88.9	Grip E 88.9	0579 9100 088	0579 8400 088	0579 9200 088	0579 8500 088	0579 9300 088	0579 8600 088	0579 9900 088
101.6	Grip E 101.6	0579 9100 101	0579 8400 101	0579 9200 101	0579 8500 101	0579 9300 101	0579 8600 101	
104.0	Grip E 104.0	0579 9100 104	0579 8400 104	0579 9200 104	0579 8500 104	0579 9300 104	0579 8600 104	
108.0	Grip E 108.0	0579 9100 108	0579 8400 108	0579 9200 108	0579 8500 108	0579 9300 108	0579 8600 108	
110.0	Grip E 110.0	0579 9100 110	0579 8400 110	0579 9200 110	0579 8500 110	0579 9300 110	0579 8600 110	
114.3	Grip E 114.3	0579 9100 114	0579 8400 114	0579 9200 114	0579 8500 114	0579 9300 114	0579 8600 114	0579 9900 114
129.0	Grip E 129.0	0579 9100 129	0579 8400 129	0579 9200 129	0579 8500 129	0579 9300 129	0579 8600 129	0579 9900 129
133.0	Grip E 133.0	0579 9100 133	0579 8400 133	0579 9200 133	0579 8500 133	0579 9300 133	0579 8600 133	
139.7	Grip E 139.7	0579 9100 139	0579 8400 139	0579 9200 139	0579 8500 139	0579 9300 139	0579 8600 139	0579 9900 139
141.3	Grip E 141.3	0579 9100 141	0579 8400 141	0579 9200 141	0579 8500 141	0579 9300 141	0579 8600 141	
154.0	Grip E 154.0	0579 9100 154	0579 8400 154	0579 9200 154	0579 8500 154	0579 9300 154	0579 8600 154	
159.0	Grip E 159.0	0579 9100 159	0579 8400 159	0579 9200 159	0579 8500 159	0579 9300 159	0579 8600 159	
168.3	Grip E 168.3	0579 9100 168	0579 8400 168	0579 9200 168	0579 8500 168	0579 9300 168	0579 8600 168	0579 9900 168

NORMACONNECT®

FGR GRIP



NORMACONNECT® GRIP axial restraint pipe couplings are used to connect metal pipes.

Material

W2, W4, W5

NORMACONNECT® FGR GRIP											
Ø (O.D.)	Designation	Clamping ranges O _{dmin} - O _{dmax} (mm)	PN ¹  [bar]	WP ²  [bar]	C max (mm)	Dimensions (approx.)			Weight (approx.) (kg/pc.)	Hex socket locking bolts	
						a (mm)	d (mm)	H (mm)		Thread	Tightening torque (Nm)
193.7	Grip 193.7	192.0 - 196.0	16	32	35	142	225	255	6.8	M 16 SW 14	150
206.0	Grip 206.0	202.0 - 208.0	16	32	35	142	240	270	7.0	M 16 SW 14	150
219.1	Grip 219.1	216.0 - 221.0	16	32	35	142	250	280	7.3	M 16 SW 14	150
225.0	Grip 225.0	222.0 - 227.0	13	26.5	35	142	255	285	7.4	M 16 SW 14	180
229.9	Grip 229.9	228.0 - 232.0	13	26	35	142	260	290	7.5	M 16 SW 14	180
244.5	Grip 244.5	242.0 - 247.0	12	24.5	35	142	275	305	7.7	M 16 SW 14	180
254.0	Grip 254.0	250.0 - 256.0	11.5	22.5	35	142	285	315	7.9	M 16 SW 14	180
267.0	Grip 267.0	264.0 - 269.0	11	22.5	35	142	300	330	8.2	M 16 SW 14	180
273.0	Grip 273.0	270.0 - 275.0	11	22	35	142	305	335	8.3	M 16 SW 14	180
306.0	Grip 306.0	302.0 - 308.0	9.5	19.5	35	142	340	370	8.9	M 16 SW 14	180
323.9	Grip 323.9	320.0 - 327.0	6.5	13	35	142	355	385	9.2	M 16 SW 14	180
326.0	Grip 326.0	322.0 - 329.0	6.5	13	35	142	360	390	9.3	M 16 SW 14	180
355.6	Grip 355.6	352.0 - 359.0	6	12	35	142	390	420	9.8	M 16 SW 14	180
406.4	Grip 406.4	402.0 - 410.0	4.5	9	35	142	440	470	10.8	M 16 SW 14	180
429.0	Grip 429.0	426.0 - 431.0	4	8.5	35	142	460	490	11.3	M 16 SW 14	180
442.0	Grip 442.0	439.0 - 444.0	4	8	35	142	475	505	11.5	M 16 SW 14	180
457.2	Grip 457.2	454.0 - 459.0	4	8	35	142	490	520	11.8	M 16 SW 14	180
508.0	Grip 508.0	505.0 - 510.0	2.5	5	35	142	540	570	12.7	M 16 SW 14	180
531.0	Grip 531.0	528.0 - 534.0	2.5	5	35	142	565	595	13.2	M 16 SW 14	180
558.8	Grip 558.8	556.0 - 562.0	2	4.5	35	142	590	620	13.7	M 16 SW 14	180
609.6	Grip 609.6	606.0 - 613.0	1.5	3	35	142	640	670	14.7	M 16 SW 14	180
634.0	Grip 634.0	631.0 - 637.0	1.5	3	35	142	665	695	15.1	M 16 SW 14	200
711.2	Grip 711.2	707.0 - 715.0	1.5	2.5	35	142	745	775	16.6	M 16 Sw 14	200

PN¹ (Nominal Pressure) is the max. admissible working pressure in shipbuilding, based on a safety factor of ≥ 4 .

WP² is the max. working pressure in industrial applications, with a safety factor as per NORMA specification.

Technical data & Ordering information

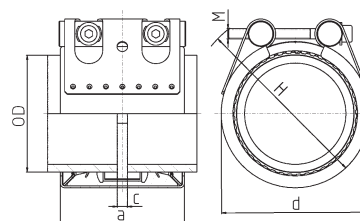

NORMACONNECT® FGR GRIP							
Ø (O.D.)	Designation	W2 Product No.		W4 Product No.		W5 Product No.	
		EPDM	NBR	EPDM	NBR	EPDM	NBR
193.7	Grip 193.7	0577 8100 193	0577 8400 193	0577 8200 193	0577 8500 193	0577 8300 193	0577 8600 193
206.0	Grip 206.0	0577 8100 206	0577 8400 206	0577 8200 206	0577 8500 206	0577 8300 206	0577 8600 206
219.1	Grip 219.1	0577 8100 219	0577 8400 219	0577 8200 219	0577 8500 219	0577 8300 219	0577 3600 219
225.0	Grip 225.0	0577 8100 225	0577 8400 225	0577 8200 225	0577 8500 225	0577 8300 225	0577 8600 225
229.9	Grip 229.9	0577 8100 229	0577 8400 229	0577 8200 229	0577 8500 229	0577 8300 229	0577 8600 229
244.5	Grip 244.5	0577 8100 244	0577 8400 244	0577 8200 244	0577 8500 244	0577 8300 244	0577 8600 244
254.0	Grip 254.0	0577 8100 254	0577 8400 254	0577 8200 254	0577 8500 254	0577 8300 254	0577 8600 254
267.0	Grip 267.0	0577 8100 267	0577 8400 267	0577 8200 267	0577 8500 267	0577 8300 267	0577 8600 267
273.0	Grip 273.0	0577 8100 273	0577 8400 273	0577 8200 273	0577 8500 273	0577 8300 273	0577 3600 273
306.0	Grip 306.0	0577 8100 306	0577 8400 306	0577 8200 306	0577 8500 306	0577 8300 306	0577 8600 306
323.9	Grip 323.9	0577 8100 323	0577 8400 323	0577 8200 323	0577 8500 323	0577 8300 323	0577 8600 323
326.0	Grip 326.0	0577 8100 326	0577 8400 326	0577 8200 326	0577 8500 326	0577 8300 326	0577 8600 326
355.6	Grip 355.6	0577 8100 355	0577 8400 355	0577 8200 355	0577 8500 355	0577 8300 355	0577 8600 355
406.4	Grip 406.4	0577 8100 406	0577 8400 406	0577 8200 406	0577 8500 406	0577 8300 406	0577 8600 406
429.0	Grip 429.0	0577 8100 429	0577 8400 429	0577 8200 429	0577 8500 429	0577 8300 429	0577 8600 429
442.0	Grip 442.0	0577 8100 442	0577 8400 442	0577 8200 442	0577 8500 442	0577 8300 442	0577 8600 442
457.2	Grip 457.2	0577 8100 457	0577 8400 457	0577 8200 457	0577 8500 457	0577 8300 457	0577 8600 457
508.0	Grip 508.0	0577 8100 508	0577 8400 508	0577 8200 508	0577 8500 508	0577 8300 508	0577 8600 508
531.0	Grip 531.0	0577 8100 531	0577 8400 531	0577 8200 531	0577 8500 531	0577 8300 531	0577 8600 531
558.8	Grip 558.8	0577 8100 558	0577 8400 558	0577 8200 558	0577 8500 558	0577 8300 558	0577 8600 558
609.6	Grip 609.6	0577 8100 609	0577 8400 609	0577 8200 609	0577 8500 609	0577 8300 609	0577 8600 609
634.0	Grip 634.0	0577 8100 634	0577 8400 634	0577 8200 634	0577 8500 634	0577 8300 634	0577 8600 634
711.2	Grip 711.2	0577 8100 711	0577 8400 711	0577 8200 711	0577 8500 711	0577 8300 711	0577 8600 711

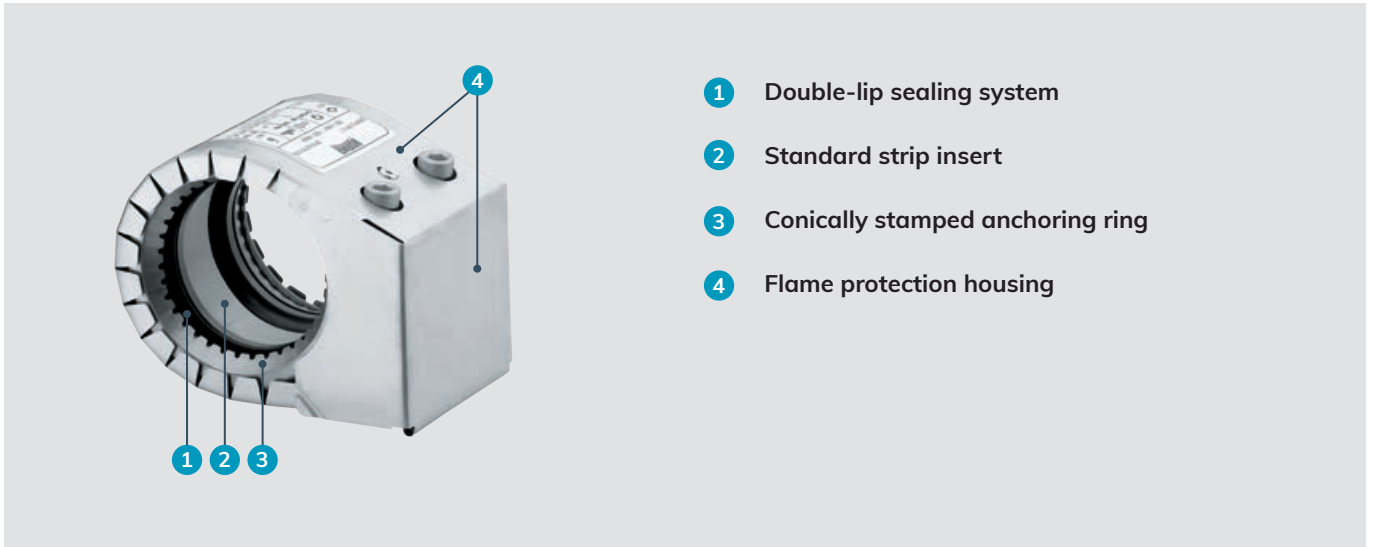

- 1 Double-lip sealing system
- 2 Standard strip insert
- 3 Conically stamped anchoring ring
- 4 Flame protection housing

The fire resistant coupling

NORMACONNECT® GRIP E-FP pipe couplings with integrated flame protection are used with applications in the marine sector (civil and military) as well as in sprinkler systems. For this purpose the GRIP E type has been equipped with an additional housing made from stainless steel plus a fire-resistant lining which can resist temperatures of 850 °C and upwards.

Advantages at a glance

- ✓ Dampens absorbing vibrations, pressure surges
- ✓ Weight saving
- ✓ Tension free
- ✓ Ready to install

Information

- Sizes: 26.9 mm – 219.1 mm
- Working pressure: 16.0 – 6.0 bar
- Material: AISI 304, AISI 316 Ti
- EPDM:
 - Sizes from 26.9 mm up to 168.3 mm: -30 °C up to +125 °C
 - Sizes > 180.0 mm: from -20 °C up to +80 °C
- NBR: from -20 °C up to +80 °C



Materials

W1	W2	W3	W4	W5
				x

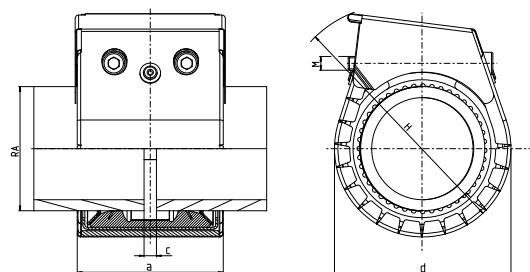
Technical data & ordering information



Technical data & Ordering information

NORMACONNECT® FGR GRIP E-FP													
Ø (O.D.)	Designation	Clamping ranges	PN ¹ (MAWP ¹ from dia- meter 180)	WP ¹	C max	Dimensions (approx.)			Weight (approx.)	Hex socket locking bolts		W5 Product No.	
			Odmin - Odmax (mm)	 [bar]	 [bar]	(mm)	a (mm)	d (mm)	H (mm)	(kg/pc.)	Thread	Tightening torque (Nm)	EPDM
26.9	Grip E-FP 26.9	26.4 - 27.5	16	70	3	67	60	110	0.42	M 8 SW 6	10	0579 9370 026	0579 8670 026
28.0	Grip E-FP 28.0	27.5 - 28.5	16	70	3	67	60	110	0.42	M 8 SW 6	10	0579 9370 028	0579 8670 028
30.0	Grip E-FP 30.0	29.5 - 30.6	16	70	3	67	60	110	0.42	M 8 SW 6	10	0579 9370 030	0579 8670 030
33.7	Grip E-FP 33.7	33.0 - 34.3	16	60	3	67	65	115	0.43	M 8 SW 6	10	0579 9370 033	0579 8670 033
35.0	Grip E-FP 35.0	34.5 - 35.6	16	60	8	75	65	115	0.58	M 8 SW 6	15	0579 9370 035	0579 8670 035
38.0	Grip E-FP 38.0	37.5 - 38.6	16	60	8	75	70	120	0.58	M 8 SW 6	15	0579 9370 038	0579 8670 038
42.4	Grip E-FP 42.4	41.7 - 43.0	16	50	8	75	75	125	0.59	M 8 SW 6	15	0579 9370 042	0579 8670 042
44.5	Grip E-FP 44.5	44.0 - 45.1	16	50	8	75	75	125	0.60	M 8 SW 6	15	0579 9370 044	0579 8670 044
48.3	Grip E-FP 48.3	47.6 - 50.5	16	50	8	75	80	130	0.61	M 8 SW 6	15	0579 9370 048	0579 8670 048
54.0	Grip E-FP 54.0	53.3 - 54.6	16	50	17	90	85	135	0.92	M 8 SW 6	15	0579 9370 054	0579 8670 054
57.0	Grip E-FP 57.0	56.3 - 57.7	16	50	17	90	90	140	0.93	M 8 SW 6	20	0579 9370 057	0579 8670 057
60.3	Grip E-FP 60.3	59.5 - 61.0	16	40	17	90	95	145	0.94	M 8 SW 6	20	0579 9370 060	0579 8670 060
73.0	Grip E-FP 73.0	72.1 - 73.8	16	40	17	90	95	145	0.94	M 10 SW 8	30	0579 9370 073	0579 8670 073
76.1	Grip E-FP 76.1	75.2 - 77.0	16	35	25	110	105	155	1.49	M 10 SW 8	30	0579 9370 076	0579 8670 076
84.0	Grip E-FP 84.0	83.0 - 85.0	16	35	25	110	110	160	1.49	M 10 SW 8	30	0579 9370 084	0579 8670 084
88.9	Grip E-FP 88.9	87.0 - 89.9	16	35	25	110	115	165	1.56	M 10 SW 8	30	0579 9370 088	0579 8670 088
101.6	Grip E-FP 101.6	100.4 - 102.8	16	35	25	110	120	170	1.59	M 10 SW 8	30	0579 9370 101	0579 8670 101
104.0	Grip E-FP 104.0	102.8 - 106.1	16	35	25	110	135	185	1.75	M 10 SW 8	30	0579 9370 104	0579 8670 104
108.0	Grip E-FP 108.0	106.8 - 109.2	16	35	25	110	135	185	1.76	M 10 SW 8	30	0579 9370 108	0579 8670 108
110.0	Grip E-FP 110.0	108.8 - 111.4	16	35	25	110	140	190	1.79	M 10 SW 8	30	0579 9370 110	0579 8670 110
114.3	Grip E-FP 114.3	113.0 - 115.5	16	35	25	110	145	195	1.89	M 10 SW 8	40	0579 9370 114	0579 8670 114
129.0	Grip E-FP 129.0	127.6 - 131.1	16	32	35	125	165	215	3.25	M 12 SW 10	50	0579 9370 129	0579 8670 129
133.0	Grip E-FP 133.0	131.5 - 134.4	16	32	35	125	170	220	3.36	M 12 SW 10	50	0579 9370 133	0579 8670 133
139.7	Grip E-FP 139.7	138.1 - 141.6	16	32	35	125	175	225	3.48	M 12 SW 10	50	0579 9370 139	0579 8670 139
141.3	Grip E-FP 141.3	139.6 - 142.8	16	32	35	125	180	230	3.48	M 12 SW 10	50	0579 9370 141	0579 8670 141
154.0	Grip E-FP 154.0	152.3 - 156.1	16	32	35	125	190	240	3.63	M 12 SW 10	60	0579 9370 154	0579 8670 154
159.0	Grip E-FP 159.0	157.3 - 160.7	16	32	35	125	195	245	3.75	M 12 SW 10	60	0579 9370 159	0579 8670 159
168.3	Grip E-FP 168.3	166.5 - 170.1	16	32	35	125	205	255	3.83	M 12 SW 10	60	0579 9370 168	0579 8670 168
193.7	Grip E-FP 193.7	192.0 - 196.0	10	20	35	125	235	285	6.9	M 16 SW 14	100	0579 9370 193	0579 8670 193
206.0	Grip E-FP 206.0	202.0 - 208.0	10	20	35	125	250	300	7.2	M 16 SW 14	100	0579 9370 206	0579 8670 206
219.1	Grip E-FP 219.1	216.0 - 221.0	10	20	35	125	260	310	7.4	M 16 SW 14	100	0574 8370 219	0574 8670 219

PN¹ (Nominal Pressure) is the max. admissible working pressure in shipbuilding, based on a safety factor of ≥ 4 .

MAWP¹ (Maximum Allowable Working Pressure) is the max. admissible working pressure in shipbuilding, based on a safety factor of ≥ 4 .

WP² is the max. working pressure in industrial applications, with a safety factor as per NORMA specification.

Bigger dimensions available on request.



- 1 Metal housing made from AISI 316 Ti
- 2 Environmentally-friendly – No use of chemicals
- 3 Shoulders of the coupling are flame protected



Double-locked safeguards prevent accidental dismantling

RFP for application at shipbuilding

The NORMACONNECT® RFP is a retrofittable flame protector housing that has been specially designed for use with all NORMACONNECT® FLEX and GRIP pipe couplings. Its low weight and straightforward design allows quick, easy assembly without any tools. The built-in flame resistant mineral fiber mat provides a premium level of flame protection. The Retrofit Flame Protector (RFP) housing has been extensively tested and is approved by several international classification societies.

Advantages at a glance

- ✓ Retrofittable
- ✓ Easy assembly without tooling
- ✓ Low weight
- ✓ Meets current IACS requirements
- ✓ No chemicals in flame protection mat
- ✓ High flexibility
- ✓ Clear identification whether coupling is flame protected or not
- ✓ Mechanical stress resistant
- ✓ Less warehouse costs

Information

Sizes from 26.9 mm up to 273.0 mm

Materials

W1	W2	W3	W4	W5
				x

Technical data & Ordering information

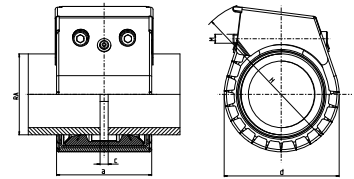

NORMACONNECT® FGR RFP						
Ø (O.D.)	Designation	Dimensions (approx.)			Weight of RFP (approx.) (kg/piece)	W5 Product No.
		a (mm)	d (mm)	H* (mm)		
26.9	NC RFP W5 RFP 26.9	69	60	110	0.09	0573 0000 026
28.0	NC RFP W5 RFP 28.0	69	60	110	0.09	0573 0000 028
30.0	NC RFP W5 RFP 30.0	69	60	110	0.10	0573 0000 030
33.7	NC RFP W5 RFP 33.7	69	65	115	0.10	0573 0000 033
38.0	NC RFP W5 RFP 38.0	75	70	120	0.11	0573 0000 038
42.4	NC RFP W5 RFP 42.4	75	75	125	0.12	0573 0000 042
44.5	NC RFP W5 RFP 44.5	75	75	125	0.12	0573 0000 044
48.3	NC RFP W5 RFP 48.3	75	80	130	0.13	0573 0000 048
54.0	NC RFP W5 RFP 54.0	90	90	135	0.14	0573 0000 054
57.0	NC RFP W5 RFP 57.0	90	90	140	0.16	0573 0000 057
60.3	NC RFP W5 RFP 60.3	90	95	145	0.16	0573 0000 060
76.1	NC RFP W5 RFP 76.1	110	110	160	0.24	0573 0000 076
88.9	NC RFP W5 RFP 88.9	110	120	170	0.26	0573 0000 088
101.6	NC RFP W5 RFP 101.6	110	135	185	0.28	0573 0000 101
104.0	NC RFP W5 RFP 104.0	110	135	185	0.29	0573 0000 104
108.0	NC RFP W5 RFP 108.0	110	140	190	0.30	0573 0000 108
114.3	NC RFP W5 RFP 114.3	110	145	195	0.31	0573 0000 114
133.0	NC RFP W5 RFP 133.0	125	170	220	0.41	0573 0000 133
139.7	NC RFP W5 RFP 139.7	125	175	225	0.43	0573 0000 139
154.0	NC RFP W5 RFP 154.0	125	190	240	0.45	0573 0000 154
159.0	NC RFP W5 RFP 159.0	125	195	245	0.49	0573 0000 159
168.3	NC RFP W5 RFP 168.3	125	205	255	0.50	0573 0000 168
219.1	NC RFP W5 RFP 219.1	155	260	310	0.73	0573 0000 219

* Dimensions of the housing are given as assembled on a NORMACONNECT® Grip/ Grip E/ Flex/ Flex E pipe coupling. Further sizes available on request.

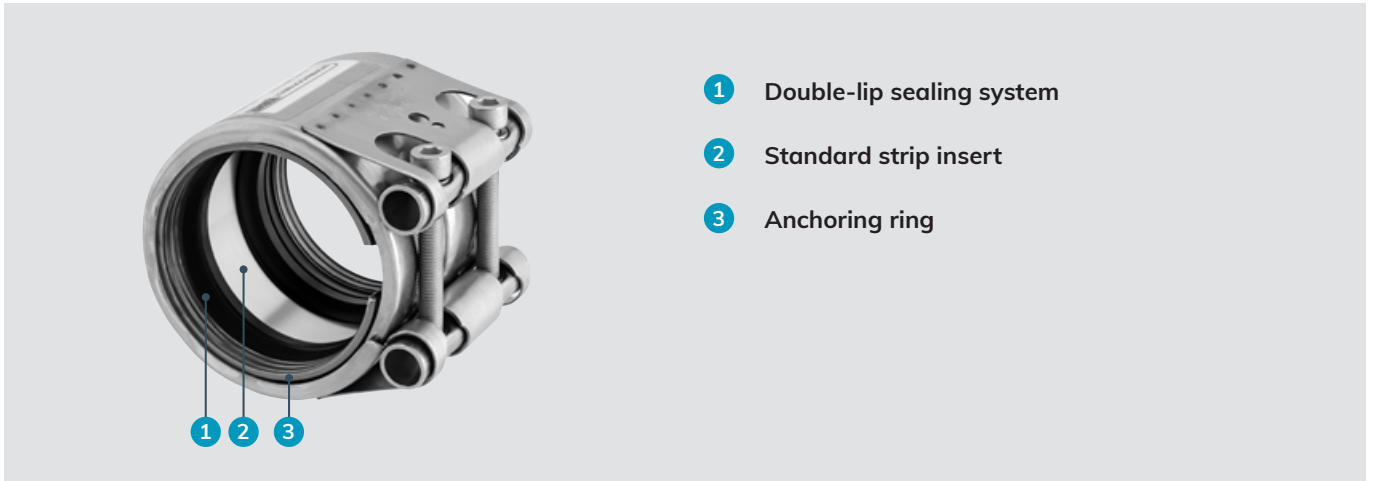

- 1 Double-lip sealing system
- 2 Standard strip insert
- 3 Anchoring ring

The coupling for plastic pipes

NORMACONNECT® PLAST GRIP/PLAST GRIP E axial restraint pipe couplings are used to connect plastic pipes. The specially designed anchoring ring, featuring flat rows of teeth, engages into the pipe surface without damaging the plastic material. The force applied is distributed evenly across the pipe surface. NORMACONNECT® PLAST GRIP E has hollow trunnions (smaller diameters). NORMACONNECT® PLAST GRIP has solid trunnions (larger diameters).

Advantages at a glance

- ✓ Also usable for smooth thermoplastics such as PP and PE.
- ✓ Also available with hollow trunnions for weight-saving

Information

- Sizes: 40.0 mm – 400.0 mm
- Working pressure: 16.0 – 6.0 bar
- Material: AISI 304, AISI 316 Ti
- EPDM:
 - Sizes from 40.0 mm up to 168.3 mm -30 °C up to +125 °C
 - Sizes > 180.0 mm: -20 °C up to +80 °C
- NBR: -20 °C up to +80 °C

Materials

W1	W2	W3	W4	W5
				x

Technical data & ordering information

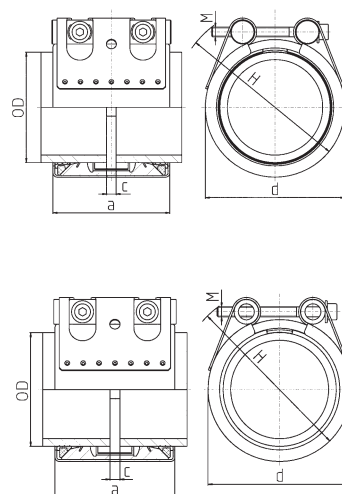



NORMACONNECT® PLAST GRIP/PLAST GRIP E axial restraint pipe couplings are used to connect plastic pipes.

Main advantage

- PLAST GRIP E has hollow trunnions and is weight-saving (available for smaller diameters)
- PLAST GRIP has solid trunnions (available for larger diameters)

Material

W5

NORMACONNECT®

Technical data & Ordering information

NORMACONNECT® FGR PLAST GRIP E													
Ø (O.D.)	Designation	Clamping ranges	PN ¹	WP ²	C max	Dimensions (approx.)			Weight (approx.)	Hex socket locking bolts		W5 Product No.	
		Oadmin - Odmax (mm)	[bar]	[bar]	(mm)	a (mm)	d (mm)	H (mm)	(kg/pc.)	Thread	Tightening torque (Nm)	EPDM	NBR
40.0	Plast Grip E W5 40	39.0 - 40.5	10	16	8	62	60	80	0.48	M 8 SW 6	15	0581 9360 040	0581 8660 040
50.0	Plast Grip E W5 50	49.0 - 50.5	10	16	8	62	70	90	0.52	M 8 SW 6	15	0581 9360 050	0581 8660 050
63.0	Plast Grip E W5 63	62.0 - 63.5	10	16	17	78	85	105	0.67	M 8 SW 6	20	0581 9360 063	0581 8660 063
75.0	Plast Grip E W5 75	74.0 - 76.0	10	16	25	98	100	120	1.33	M 10 SW 8	30	0581 9360 075	0581 8660 075
90.0	Plast Grip E W5 90	89.0 - 91.0	10	16	25	98	110	130	1.42	M 10 SW 8	30	0581 9360 090	0581 8660 090
110.0	Plast Grip E W5 110	109.0 - 111.0	10	16	25	98	130	150	1.66	M 10 SW 8	30	0581 9360 110	0581 8660 110
125.0	Plast Grip E W5 125	124.0 - 126.0	10	16	35	115	140	160	1.42	M 12 SW 10	40	0581 9360 125	0581 8660 125
140.0	Plast Grip E W5 140	139.0 - 141.0	10	16	35	115	160	180	1.18	M 12 SW 10	50	0581 9360 140	0581 8660 140
154.0	Plast Grip E W5 154	152.3 - 156.1	10	16	35	115	170	190	1.27	M 12 SW 10	50	0581 9360 154	0581 8660 154
160.0	Plast Grip E W5 160	159.0 - 162.0	10	16	35	115	180	200	1.45	M 12 SW 10	60	0581 9360 160	0581 8660 160

NORMACONNECT® FGR PLAST GRIP													
Ø (O.D.)	Designation	Clamping ranges	PN ¹	WP ²	C max	Dimensions (approx.)			Weight (approx.)	Hex socket locking bolts		W5 Product No.	
		Oadmin - Odmax (mm)	[bar]	[bar]	(mm)	a (mm)	d (mm)	H (mm)	(kg/pc.)	Thread	Tightening torque (Nm)	EPDM	NBR
180.0	Plast Grip W5 180	178.0 - 182.0	-	16	35	142	210	240	7.6	M 12 SW 10	60	0581 8350 180	0581 8650 180
200.0	Plast Grip W5 200	198.0 - 202.0	-	16	35	142	230	260	8.1	M 12 SW 10	60	0581 8350 200	0581 8650 200
225.0	Plast Grip W5 225	222.0 - 227.0	-	10	35	142	255	285	8.7	M 12 SW 10	60	0581 8350 225	0581 8650 225
250.0	Plast Grip W5 250	247.0 - 253.0	-	10	35	142	280	310	9.4	M 12 SW 10	80	0581 8350 250	0581 8650 250
280.0	Plast Grip W5 280	277.0 - 283.0	-	10	35	142	310	340	10.1	M 16 SW 14	100	0581 8350 280	0581 8650 280
315.0	Plast Grip W5 315	311.0 - 318.0	-	10	35	142	345	375	11	M 16 SW 14	100	0581 8350 315	0581 8650 315
355.0	Plast Grip W5 355	352.0 - 359.0	-	6	35	142	385	415	12	M 16 SW 14	120	0581 8350 355	0581 8650 355
400.0	Plast Grip W5 400	396.0 - 404.0	-	6	35	142	430	460	13.1	M 16 SW 14	120	0581 8350 400	0581 8650 400

PN¹ (Nominal Pressure) is the max. admissible working pressure in shipbuilding, based on a safety factor of ≥ 4.
 WP² is the max. working pressure in industrial applications, with a safety factor as per NORMA specification.

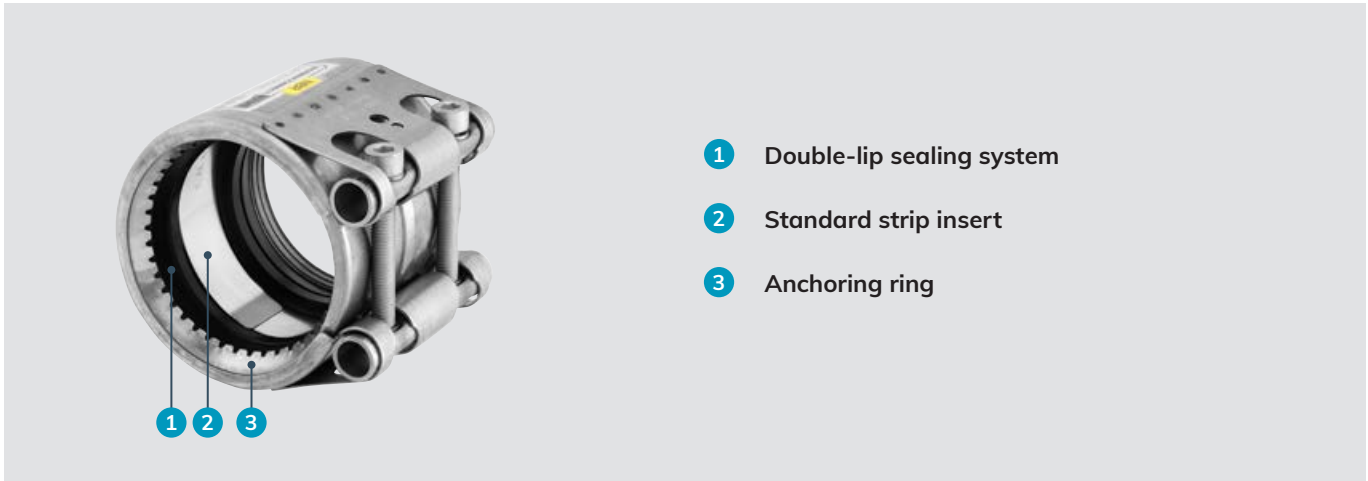

- 1 Double-lip sealing system
- 2 Standard strip insert
- 3 Anchoring ring

The combining pipe coupling

NORMACONNECT® COMBI GRIP/COMBI GRIP E axial restraint pipe couplings are used to connect plastic pipes with metal pipes.

On the side connecting the plastic pipe, the coupling has a special anchoring ring with rows of flat teeth which are pressed into the pipe surface without damaging the material. At the same time the force applied is distributed evenly across the pipe surface.

On the side connecting the metal pipe, the coupling has a different anchoring ring with conically stamped teeth which grip into the pipe surface. Due to the special design of the anchoring ring the coupling can withstand even high vibration loads. NORMACONNECT® COMBI GRIP E has hollow trunnions (smaller diameters). NORMACONNECT® COMBI GRIP has solid trunnions (larger diameters).

Advantages at a glance

- ✓ Corrosion resistant
- ✓ No welding
- ✓ No special tools necessary
- ✓ Installation and working in every kind of weather (hot and cold)
- ✓ Reusable

Information

- Sizes: from 38.0/40.0 mm to 400.0/406.0 mm
- Working pressure: 16.0 – 6.0 bar
- Material: AISI 304, AISI 316 Ti
- EPDM:
 - Sizes from 38.0 mm up to 160.0 mm: -30 °C up to +125 °C
 - Sizes > 200.0 mm: -20 °C up to +80 °C
- NBR: from -20 °C up to +80 °C

Materials

W1	W2	W3	W4	W5
				x

Technical data & Ordering information

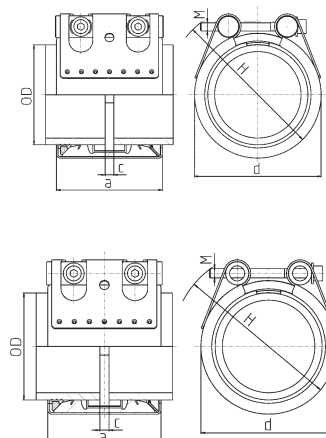



NORMACONNECT® COMBI GRIP/COMBI GRIP E axial restraint pipe couplings are used to connect plastic pipes with metal pipes.



Advantages at a glance

- COMBI GRIP E has hollow trunnions (smaller diameters)
- COMBI GRIP has solid trunnions (larger diameters)

Material

W5

Technical data & Ordering information

NORMACONNECT® FGR COMBI GRIP E														
Ø (O.D.)	Designation	Clamping ranges O _{dmin} - O _{dmax} (mm)		PN ¹  [bar]	WP ²  [bar]	C max (mm)	Dimensions (approx.)			Weight (approx.) (kg/pc.)	Hex socket locking bolts		W5 Product No.	
		Plastic	Metal				a (mm)	d (mm)	H (mm)		Thread	Tight- ening torque (Nm)	EPDM	NBR
38.0 / 40.0	Combi Grip E 38.0 / 40.0	39.0-40.5	37.5-38.6	10	16	8	62	60	80	0.46	M 8 SW 6	15	0584 9360 038	0584 8660 038
40.0 / 42.4	Combi Grip E 40.0 / 42.4	39.0-40.5	41.7-43.0	10	16	8	62	65	85	0.47	M 8 SW 6	15	0584 9360 042	0584 8660 042
50.0 / 48.3	Combi Grip E 50.0 / 48.3	47.6-51.0	47.6-50.5	10	16	8	62	70	90	0.5	M 8 SW 6	15	0584 9360 048	0584 8660 048
56.0 / 54.0*	Combi Grip E 56.0 / 54.0	55.0-56.5	53.3-54.6	-	5*	17	78	80	100	0.62	M 8 SW 6	15	0584 9360 054	0584 8660 054
63.0 / 60.3	Combi Grip E 63.0 / 60.3	62.0-63.5	59.5-61.0	10	16	17	78	85	105	0.65	M 8 SW 6	20	0584 9360 060	0584 8660 060
75.0 / 76.1	Combi Grip E 75.0 / 76.1	74.0-76.0	75.2-77.0	10	16	25	98	100	120	1.3	M 10 SW 8	30	0584 9360 076	0584 8660 076
90.0 / 88.9	Combi Grip E 90.0 / 88.9	89.0-91.0	87.0-89.9	10	16	25	98	110	130	1.39	M 10 SW 8	30	0584 9360 088	0584 8660 088
110.0 / 108.0	Combi Grip E 110.0 / 108.0	109.0-111.0	106.8-109.2	10	16	25	98	130	150	1.58	M 10 SW 8	40	0584 9360 108	0584 8660 108
110.0 / 114.3	Combi Grip E 110.0 / 114.3	109.0-111.0	113.0-115.5	10	16	25	98	135	155	1.62	M 10 SW 8	40	0584 9360 110	0584 8660 110
140.0 / 139.7	Combi Grip E 140.0 / 139.7	139.0-141.0	138.1-141.6	10	16	35	115	160	180	3.14	M 12 SW 10	50	0584 9360 139	0584 8660 139
160.0 / 159.0	Combi Grip E 159.0 / 160.0	159.0-162.0	157.3-160.7	10	16	35	115	180	200	3.45	M 12 SW 10	60	0584 9360 159	0584 8660 159

NORMACONNECT® FGR COMBI GRIP														
Ø (O.D.)	Designation	Clamping ranges O _{dmin} - O _{dmax} (mm)		PN ¹  [bar]	WP ²  [bar]	C max (mm)	Dimensions (approx.)			Weight (approx.) (kg/pc.)	Hex socket locking bolts		W5 Product No.	
		Plastic	Metal				a (mm)	d (mm)	H (mm)		Thread	Tight- ening torque (Nm)	EPDM	NBR
200.0 / 204.0	Combi Grip 200.0 / 204.0	198.0-202.0	202.0-206.0	-	16	35	142	235	265	7.5	M 12 SW 10	60	0584 8350 204	0584 8650 204
225.0 / 219.1	Combi Grip 225.0 / 219.1	222.0-227.0	216.0-221.0	-	10	35	142	255	285	8.1	M 12 SW 10	60	0584 8350 220	0584 8650 220
225.0 / 222.0	Combi Grip 225.0 / 222.0	222.0-227.0	220.0-224.0	-	10	35	142	255	285	8.1	M 12 SW 10	60	0584 8350 222	0584 8650 222
250.0 / 254.0	Combi Grip 250.0 / 254.0	247.0-253.0	250.0-256.0	-	10	35	142	285	315	8.6	M 12 SW 10	80	0584 8350 254	0584 8650 254
280.0 / 273.0	Combi Grip 280.0 / 273.0	277.0-283.0	270.0-275.0	-	10	35	142	310	340	9.3	M 16 SW 14	100	0584 8350 273	0584 8650 273
355.0 / 355.6	Combi Grip 355.0 / 355.6	351.0-359.0	352.0-359.0	-	6	35	142	390	420	10.9	M 16 SW 14	120	0584 8350 355	0584 8650 355
400.0 / 406.4	Combi Grip 400.0 / 406.4	396.0-404.0	402.0-410.0	-	6	35	142	440	470	11.9	M 16 SW 14	120	0584 8350 400	0584 8650 400

PN¹ (Nominal Pressure) is the max. admissible working pressure in shipbuilding, based on a safety factor of ≥ 4.

WP² is the max. working pressure in industrial applications, with a safety factor as per NORMA specification.

* Special coupling for joining metal pipes with PE-HD drainage pipes



Support sleeve to be used with **NORMACONNECT® PLAST GRIP/PLAST GRIP E, COMBI GRIP GRIP E** in W5 (316Ti) material.

For copper and CuNiFe pipes an optional support sleeve made from brass is available on request.

Optional support sleeve

When joining plastic pipes made from PE and PP a support sleeve must be used. If the pipes to be joined are made from soft thermoplastic (e.g., PE) the use of a support sleeve is mandatory. The support sleeve is inserted into the pipe end within the area to be joined and thus protects the pipe from being deformed.

Technical data & Ordering information

INTERNAL SUPPORT SLEEVE FOR PLAST GRIP / PLAST GRIP E IN W5 (316Ti)*						
PE	SDR 11		SDR 13.6		SDR 17	
Ø OD mm	Product No.	Ø mm	Product No.	Ø mm	Product No.	Ø mm
40	0581 0011 040	32.6	0581 0013 040	34.0	0581 0017 040	35.2
50	0581 0011 050	40.8	0581 0013 050	42.6	0581 0017 050	44.0
63	0581 0011 063	51.4	0581 0013 063	53.6	0581 0017 063	55.4
75	0581 0011 075	61.4	0581 0013 075	63.8	0581 0017 075	66.0
90	0581 0011 090	73.6	0581 0013 090	76.6	0581 0017 090	79.2
110	0581 0011 110	90.0	0581 0013 110	93.8	0581 0017 110	96.8
125	0581 0011 125	102.2	0581 0013 125	106.6	0581 0017 125	110.2
140	0581 0011 140	114.6	0581 0013 140	119.4	0581 0017 140	123.4
160	0581 0011 160	130.8	0581 0013 160	136.4	0581 0017 160	141.0
180	0581 0011 180	147.2	0581 0013 180	153.4	0581 0017 180	158.6
200	0581 0011 200	163.6	0581 0013 200	170.6	0581 0017 200	176.2
225	0581 0011 225	184.0	0581 0013 225	191.8	0581 0017 225	198.2
250	0581 0011 250	204.6	0581 0013 250	213.2	0581 0017 250	220.4
280	0581 0011 280	229.2	0581 0013 280	238.8	0581 0017 280	246.8
315	0581 0011 315	257.8	0581 0013 315	268.6	0581 0017 315	277.6
355	0581 0011 355	290.6	0581 0013 355	302.8	0581 0017 355	312.8
400	0581 0011 400	327.4	0581 0013 400	341.2	0581 0017 400	352.6
450	0581 0011 450		0581 0013 450		0581 0017 450	

Table continues on next page
* Other SDR classes on request.

Technical data & Ordering information

NORMACONNECT®

INTERNAL SUPPORT SLEEVE FOR PLAST GRIP / PLAST GRIP E IN W5 (316TI)*				
PE	SDR 17.6		SDR 21	
Ø OD mm	Product No.	Ø mm	Product No.	Ø mm
40	0581 0018 040	35.4	0581 0021 040	36.0
50	0581 0018 050	44.2	0581 0021 050	45.2
63	0581 0018 063	55.8	0581 0021 063	57.0
75	0581 0018 075	66.4	0581 0021 075	67.8
90	0581 0018 090	79.8	0581 0021 090	81.4
110	0581 0018 110	97.4	0581 0021 110	99.4
125	0581 0018 125	110.8	0581 0021 125	113.0
140	0581 0018 140	124.0	0581 0021 140	126.6
160	0581 0018 160	141.8	0581 0021 160	144.6
180	0581 0018 180	159.6	0581 0021 180	162.8
200	0581 0018 200	177.2	0581 0021 200	180.8
225	0581 0018 225	199.4	0581 0021 225	203.4
250	0581 0018 250	221.6	0581 0021 250	226.2
280	0581 0018 280	248.2	0581 0021 280	253.2
315	0581 0018 315	279.2	0581 0021 315	285.0
355	0581 0018 355	314.8	0581 0021 355	321.2
400	0581 0018 400	354.6	0581 0021 400	361.8
450	0581 0018 450	399.0	0581 0021 450	407.0

* Other SDR classes on request

INTERNAL SUPPORT SLEEVE FOR PLAST GRIP / PLAST GRIP E IN W5 (316TI)*						
PP	SDR 11		SDR 17		SDR 17.6	
Ø OD mm	Product No.	Ø mm	Product No.	Ø mm	Product No.	Ø mm
40	0581 1011 040	32.6	0581 1017 040	35.2	0581 1018 040	35.4
50	0581 1011 050	40.8	0581 1017 050	44.0	0581 1018 050	44.2
63	0581 1011 063	51.4	0581 1017 063	55.4	0581 1018 063	55.8
75	0581 1011 075	61.4	0581 1017 075	66.0	0581 1018 075	66.4
90	0581 1011 090	73.6	0581 1017 090	79.2	0581 1018 090	79.8
110	0581 1011 110	90.0	0581 1017 110	96.8	0581 1018 110	97.4
125	0581 1011 125	102.2	0581 1017 125	110.2	0581 1018 125	110.8
140	0581 1011 140	114.6	0581 1017 140	123.4	0581 1018 140	124.0
160	0581 1011 160	130.8	0581 1017 160	141.0	0581 1018 160	141.8
180	0581 1011 180	147.2	0581 1017 180	158.6	0581 1018 180	159.6
200	0581 1011 200	163.6	0581 1017 200	176.2	0581 1018 200	177.2
225	0581 1011 225	184.0	0581 1017 225	198.2	0581 1018 225	199.4
250	0581 1011 250	204.6	0581 1017 250	220.4	0581 1018 250	221.6
280	0581 1011 280	229.2	0581 1017 280	246.8	0581 1018 280	248.2
315	0581 1011 315	257.8	0581 1017 315	277.6	0581 1018 315	279.2
355	0581 1011 355	290.6	0581 1017 355	312.8	0581 1018 355	314.8
400	0581 1011 400	327.4	0581 1017 400	352.6	0581 1018 400	354.6
450	0581 1011 450	368.2	0581 1017 450	396.6	0581 1018 450	399.0

* Other SDR classes on request

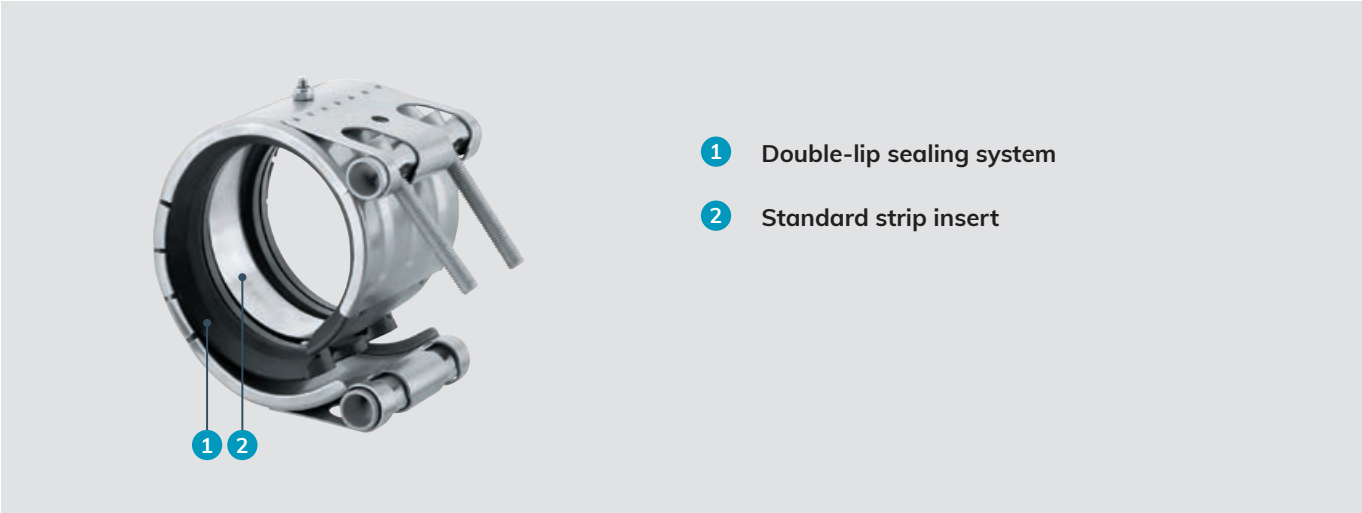

- 1 Double-lip sealing system
- 2 Standard strip insert

The repair coupling

NORMACONNECT® REP E are non-restraint repair couplings. They are used to seal damaged metal and plastic pipes. They also enable repairs to be carried out easily, quickly and safely without the need to dismantle the pipes.

Advantages at a glance

- ✔ Ensures a reliable, safe, leakage-free seal of pipe damages
- ✔ Enables easy, quick and safe repair without dismantling the pipes
- ✔ Easy to install without special tools

Information

- Sizes: from 35.0 mm to 1219.1 mm
- Working pressure: from 60.0 bar to 4.0 bar
- Material: AISI 316 Ti
- EPDM:
 - Sizes from 35.0 mm up to 168.3 mm: -30 °C up to +125 °C
 - Sizes > 180.0 mm: -20 °C up to +80 °C
- NBR : from -20 °C up to +80 °C

Materials

W1	W2	W3	W4	W5
				x

Technical data & Ordering information

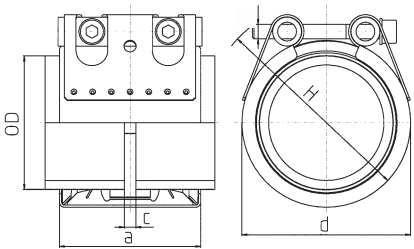

Technical data & Ordering information

NORMA CONNECT®

NORMA CONNECT® FGR REP E												
Ø (O.D.)	Designation	Clamping ranges	WP ¹	C max	Dimensions (approx.)			Weight (approx.)	Hex socket locking bolts		W5 Product No.	
		O _{dmin} - O _{dmax} (mm)	 [bar]	(mm)	a (mm)	d (mm)	H (mm)	(kg/pc.)	Thread	Tightening torque (Nm)	EPDM	NBR
35.0	Rep E W5 35.0	34.5 - 35.6	60	8	63	55	75	0.41	M 8 SW 6	5	0572 9360 035	0572 8660 035
38.0	Rep E W5 38.0	37.5 - 38.6	60	8	63	60	80	0.41	M 8 SW 6	5	0572 9360 038	0572 8660 038
42.4	Rep E W5 42.4	41.7 - 43.0	50	8	63	65	85	0.42	M 8 SW 6	5	0572 9360 042	0572 8660 042
44.5	Rep E W5 44.5	44.0 - 45.1	50	8	63	65	85	0.43	M 8 SW 6	5	0572 9360 044	0572 8660 044
48.3	Rep E W5 48.3	47.6 - 50.5	50	8	63	70	90	0.44	M 8 SW 6	5	0572 9360 048	0572 8660 048
54.0	Rep E W5 54.0	53.3 - 54.6	50	17	78	75	95	0.58	M 8 SW 6	10	0572 9360 054	0572 8660 054
57.0	Rep E W5 57.0	56.3 - 57.7	50	17	78	80	100	0.58	M 8 SW 6	10	0572 9360 057	0572 8660 057
60.3	Rep E W5 60.3	59.5 - 61.0	40	17	78	85	105	0.59	M 8 SW 6	10	0572 9360 060	0572 8660 060
70.0	Rep E W5 70.0	69.0 - 71.0	40	25	98	90	110	0.59	M 8 SW 6	10	0572 9360 070	0572 8660 070
73.0	Rep E W5 73.0	72.1 - 73.8	40	25	98	95	115	1.13	M 8 SW 6	10	0572 9360 073	0572 8660 073
76.1	Rep E W5 76.1	75.2 - 77.0	35	25	98	100	120	1.13	M 8 SW 6	10	0572 9360 076	0572 8660 076
78.0	Rep E W5 78.0	77.1 - 78.9	35	25	98	100	120	1.14	M 8 SW 6	15	0572 9360 078	0572 8660 078
80.0	Rep E W5 80.0	79.0 - 80.8	35	25	98	100	120	1.16	M 8 SW 6	15	0572 9360 080	0572 8660 080
84.0	Rep E W5 84.0	83.0 - 85.0	35	25	98	105	125	1.18	M 8 SW 6	15	0572 9360 084	0572 8660 084
88.9	Rep E W5 88.9	87.0 - 89.9	35	25	98	110	130	1.20	M 8 SW 6	15	0572 9360 088	0572 8660 088
101.6	Rep E W5 101.6	100.4 - 102.8	35	25	98	125	145	1.33	M 8 SW 6	15	0572 9360 101	0572 8660 101
104.0	Rep E W5 104.0	102.8 - 106.1	35	25	98	125	145	1.36	M 8 SW 6	15	0572 9360 104	0572 8660 104
108.0	Rep E W5 108.0	106.8 - 109.2	35	25	98	130	150	1.40	M 8 SW 6	15	0572 9360 108	0572 8660 108
110.0	Rep E W5 110.0	108.8 - 111.4	35	25	98	130	150	1.40	M 8 SW 6	20	0572 9360 110	0572 8660 110
114.3	Rep E W5 114.0	113.0 - 115.5	35	25	98	135	155	1.99	M 8 SW 6	30	0572 9360 114	0572 8660 114
129.0	Rep E W5 129.0	127.6 - 131.1	32	35	113	155	185	2.00	M 10 SW 8	30	0572 9360 129	0572 8660 129
133.0	Rep E W5 133.0	131.5 - 134.4	32	35	113	160	190	2.03	M 10 SW 8	30	0572 9360 133	0572 8660 133
139.7	Rep E W5 139.7	138.1 - 141.6	32	35	113	165	195	2.08	M 10 SW 8	30	0572 9360 139	0572 8660 139
141.3	Rep E W5 141.3	139.6 - 142.8	32	35	113	170	200	2.09	M 10 SW 8	35	0572 9360 141	0572 8660 141
154.0	Rep E W5 154.0	152.3 - 156.1	32	35	113	180	210	2.19	M 10 SW 8	50	0572 9360 154	0572 8660 154
159.0	Rep E W5 159.0	157.3 - 160.7	32	35	113	185	215	2.26	M 10 SW 8	50	0572 9360 159	0572 8660 159
168.3	Rep E W5 168.0	166.5 - 170.1	32	35	113	195	225	2.31	M 10 SW 8	50	0572 9360 168	0572 8660 168
180.0	Rep E W5 180.0	178.0 - 182.0	30.0	35	139	210	240	4.0	M 12 SW 10	25	0576 8360 180	0576 8660 180
193.7	Rep E W5 193.7	192.0 - 196.0	28.0	35	139	225	255	4.1	M 12 SW 10	25	0576 8360 193	0576 8660 193
206.0	Rep E W5 206.0	202.0 - 208.0	26.5	35	139	240	270	4.3	M 12 SW 10	25	0576 8360 206	0576 8660 206
219.0	Rep E W5 219.0	216.0 - 221.0	23.0	35	139	250	280	4.4	M 12 SW 10	25	0576 8360 219	0576 8660 219
225.0	Rep E W5 225.0	222.0 - 227.0	23.0	35	139	255	285	4.5	M 12 SW 10	25	0576 8360 225	0576 8660 225
229.9	Rep E W5 229.9	228.0 - 232.0	23.0	35	139	260	290	4.5	M 12 SW 10	25	0576 8360 229	0576 8660 229
244.5	Rep E W5 244.5	242.0 - 247.0	22.0	35	139	275	305	4.7	M 12 SW 10	25	0576 8360 244	0576 8660 244
254.0	Rep E W5 254.0	250.0 - 256.0	21.0	35	139	285	315	4.8	M 12 SW 10	25	0576 8360 254	0576 8660 254
267.0	Rep E W5 267.0	264.0 - 269.0	20.0	35	139	300	330	5.0	M 12 SW 10	25	0576 8360 267	0576 8660 267
273.0	Rep E W5 273.0	270.0 - 275.0	20.0	35	139	305	335	5.1	M 12 SW 10	25	0576 8360 273	0576 8660 273
306.0	Rep E W5 306.0	302.0 - 308.0	17.5	35	139	340	370	5.5	M 12 SW 10	25	0576 8360 306	0576 8660 306
323.9	Rep E W5 323.9	320.0 - 327.0	17.5	35	139	355	385	5.7	M 12 SW 10	25	0576 8360 323	0576 8660 323
326.0	Rep E W5 326.0	322.0 - 329.0	16.5	35	139	360	390	5.7	M 12 SW 10	25	0576 8360 326	0576 8660 326
355.6	Rep E W5 355.6	352.0 - 359.0	15.0	35	139	390	420	6.0	M 12 SW 10	25	0576 8360 355	0576 8660 355
406.4	Rep E W5 406.4	402.0 - 410.0	14.0	35	139	440	470	6.6	M 12 SW 10	25	0576 8360 406	0576 8660 406
429.0	Rep E W5 429.0	426.0 - 431.0	13.0	35	139	460	490	6.9	M 12 SW 10	40	0576 8360 429	0576 8660 429
442.0	Rep E W5 442.0	439.0 - 444.0	13.0	35	139	475	505	7.1	M 12 SW 10	40	0576 8360 442	0576 8660 442
457.2	Rep E W5 457.2	454.0 - 459.0	12.0	35	139	490	520	7.3	M 12 SW 10	40	0576 8360 457	0576 8660 457
508.0	Rep E W5 508.0	505.0 - 510.0	11.0	35	139	540	570	7.9	M 12 SW 10	40	0576 8360 508	0576 8660 508
531.0	Rep E W5 531.0	528.0 - 534.0	10.5	35	139	565	595	8.1	M 12 SW 10	40	0576 8360 531	0576 8660 531
558.8	Rep E W5 558.8	556.0 - 562.0	10.0	35	139	590	620	8.5	M 12 SW 10	40	0576 8360 558	0576 8660 558
609.6	Rep E W5 609.6	606.0 - 613.0	9.0	35	139	640	670	9.1	M 12 SW 10	40	0576 8360 609	0576 8660 609
634.0	Rep E W5 634.0	631.0 - 637.0	8.0	35	139	665	695	9.4	M 12 SW 10	40	0576 8360 634	0576 8660 634
711.2	Rep E W5 711.2	707.0 - 715.0	7.0	35	139	745	775	10.3	M 12 SW 10	40	0576 8360 711	0576 8668 711
762.0	Rep E W5 762.0	758.0 - 766.0	7.0	35	139	795	825	10.9	M 12 SW 10	40	0576 8360 762	0576 8668 762
812.8	Rep E W5 812.8	808.0 - 817.0	6.5	35	139	845	875	11.5	M 12 SW 10	40	0576 8368 812	0576 8668 812
914.4	Rep E W5 914.4	909.0 - 919.0	5.5	35	139	945	975	12.7	M 12 SW 10	45	0576 8368 914	0576 8668 914
1016.0	Rep E W5 1016.0	1013.0 - 1019.0	5.0	35	139	1050	1080	13.9	M 12 SW 10	45	0576 8368 016	0576 8668 016
1117.5	Rep E W5 1117.5	1114.0 - 1120.0	4.5	35	139	1150	1180	15.1	M 12 SW 10	50	0576 8368 117	0576 8668 117
1219.2	Rep E W5 1219.2	1216.0 - 1222.0	4.0	35	139	1250	1280	16.3	M 12 SW 10	50	0576 8368 219	0576 8668 219

Coupling sizes > 800 mm are in 2-parts design! Sizes > 1219.2 on request



Certificates, Liability, Memberships

Certificates

Materialprüfungsamt Nordrhein-Westfalen (MPA NRW)

Liability

Product liability: In case of bodily injury and/or material damage.

Memberships

IZEG – Informationszentrum Entwässerungstechnik Guss
 GEG – Gütergemeinschaft Entwässerungstechnik Guss



Informationszentrum
 Entwässerungstechnik Guss e.V.









Materials at a glance

Materials for connectors and claws				
	Codllar	Clamping unit	Screws, Nuts, Bolts	Sealing sleeve
W1			Steel, protected surface	–
W2	AISI 430 Ti	AISI 304	Steel, protected surface	EPDM
W4	AISI 304	AISI 304	AISI 304	EPDM
W5	AISI 316 Ti	AISI 316 Ti	AISI 316	EPDM

Materials for NORMACONNECT® pipe couplings				
	Collar	Clamping unit	Screws	Sealing sleeve
W2	AISI 304	Steel, protected surface	Steel, protected surface	EPDM
W5	AISI 316 Ti	AISI 316 Ti	AISI 316	EPDM

Products and Application at a glance

TYPE	DN and Pressure [bar]														Seal Type	Material	Application				
	40	50	70	75	75 S	75/80	100	125	150	200	250	300	400	500			600	Stand-ard	Build-ings	Bridges	Soil
NON-PULL-OUT resistant connections																					
RAPID 		•	•			•	•	•	•	•							EPDM	W 2	•	-	-
RAPID 		•	•			•	•	•	•	•	•						EPDM	W 5	•	•	•
MSM RAPID 		•	•			•	•	•	•	•							EPDM	W 2	•	-	-
Pull-out resistant connections																					
UNIVERSAL Claw * 		10	10			10	10	10	5	5	3	3					-	W 2	•	-	-
RECORD Claw * 		10	10			10	10	5	5	3							-	W 1	•	-	-
COMBI Claw * 		10	10			10	10	5	5	5	3	3					-	W 1	•	-	-
Changeover connectors																					
CONFIX 		•	•			•	•	•									EPDM	-	•	-	-

Technical Changes reserved

* The claws are only suitable for open drainage systems. It is not allowed for use in closed pressure systems.

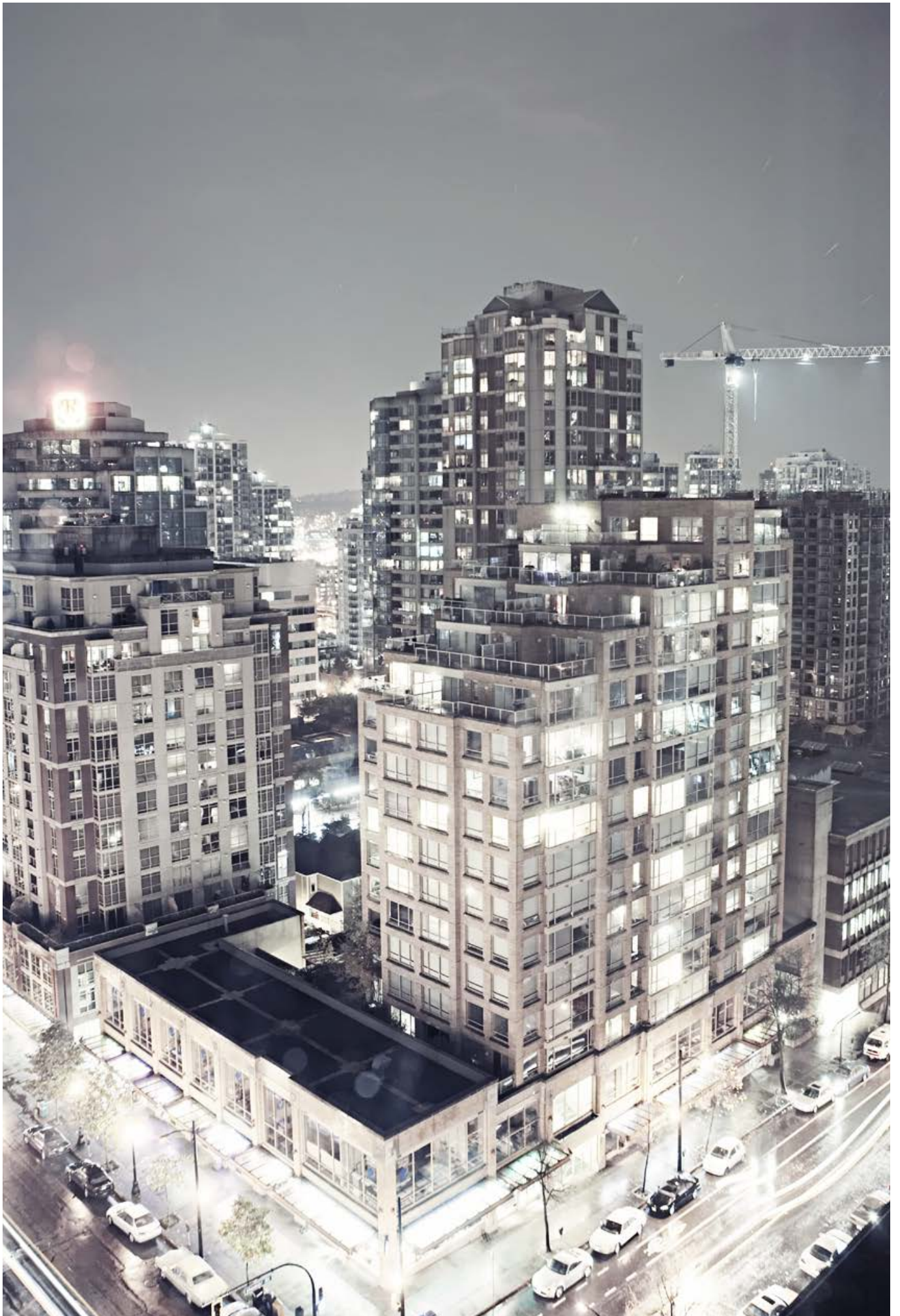

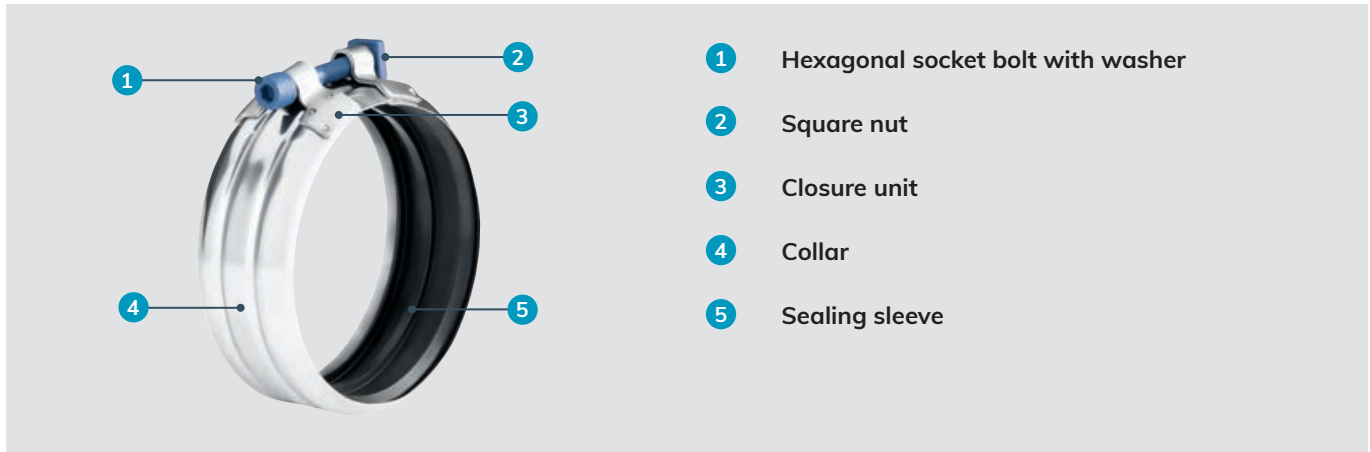

The original Rapid with block tightening

The NORMACONNECT® DCS RAPID with block tightening for non-pull-out resistant connections enables a fast connection. The visible torque control and the single-bolt closure provide for a fast and easy installation. Our DCS RAPID is the perfect solution to connect drainage fittings and pipes made of cast iron acc. to EN 877.

Materials

W1	W2	W3	W4	W5
	x			x

W2

- Material, Collar: AISI 430 Ti
- Material, Clamping unit: AISI 304 / AISI 430 Ti
- Material, Bolts/Nuts: Steel, surface protected
- Material, Sealing sleeve: EPDM

W5

- Material, Collar: AISI 316Ti
- Material, Clamping unit: AISI 316Ti
- Material, Bolts/Nuts, Steel, surface protected
- Material, Sealing sleeve: EPDM

Information

- DN 50 – DN 200: Resisting axial pull-out forces up to max. 0.5 bar
- DN 250 – DN 300: Resisting axial pull-out forces up to max. 0.3 bar
- Defined locking torque without using a special tool
- Meeting the fire protection requirements

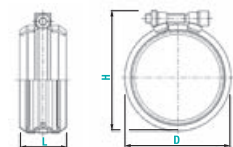

Technical data & Ordering information

NORMACONNECT® DCS RAPID									
Designation	Max. Dimensions after Assembly ~							W2 Product No.	W5 Product No.
	DN	D (mm)	H (mm)	L (mm)	P max (bar)	Torque (Nm)	Bolt (mm)		
RAPID DN 50	50	70	80	46	0.5	Tight-Locking	M 8	0245 8218 050	0245 8126 050
RAPID DN 70	70	90	100	43	0.5	Tight-Locking	M 8	0245 8219 070	0245 8127 070
RAPID DN 75 S	75	87	97	40.5	0.5	Tight-Locking	M 8	0245 8265 075	
RAPID DN 80	75/80	95	105	40	0.5	Tight-Locking	M 8	0245 8220 080	0245 8129 075
RAPID DN 100	100	125	135	39.0	0.5	Tight-Locking	M 8	0245 8221 100	0245 8130 100
RAPID DN 125	125	147	162	37.0	0.5	Tight-Locking	M 8	0245 8222 125	0245 8131 125
RAPID DN 150	150	172	187	35.5	0.5	Tight-Locking	M 8	0245 8223 150	0245 8132 150
RAPID DN 200	200	227	244	33.5	0.5	Tight-Locking	M 10	0245 8224 200	0245 8133 200
RAPID DN 250	250	293	306	96	0.3	Tight-Locking	M 10		0245 8208 250
RAPID DN 300	300	345	360	96	0.3	Tight-Locking	M 10		0245 8209 300

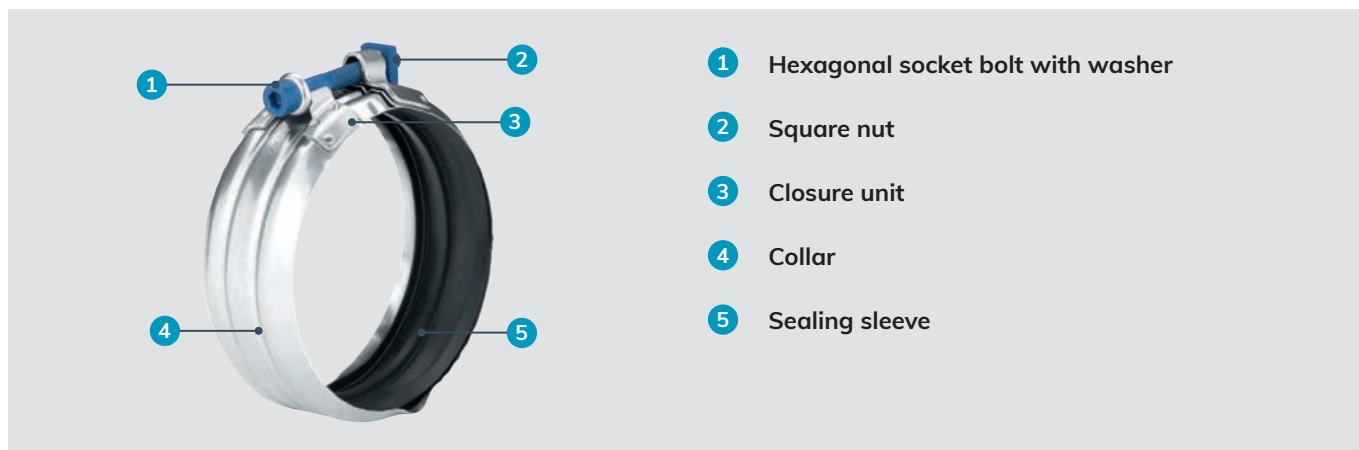

- 1 Hexagonal socket bolt with washer
- 2 Square nut
- 3 Closure unit
- 4 Collar
- 5 Sealing sleeve

The fast connection with quick release closure

The NORMACONNECT® DCS RAPID MSM connection is easy-fitting and thus especially suitable for repair purposes. It is the fast connection with quick release closure for non-pull-out resistant connections.



NORMACONNECT®

Materials

W1	W2	W3	W4	W5
	x			

W2

- Material, Collar: AISI 430 Ti
- Material, Clamping unit: AISI 304 / AISI 430 Ti
- Material, Bolts/Nuts: Steel, surface protected
- Material, Sealing sleeve: EPDM

Information

- Resisting axial pull-out forces up to max. 0.5 bar
- Defined locking torque without using a special tool
- Meeting the fire protection requirements

Technical data & Ordering information

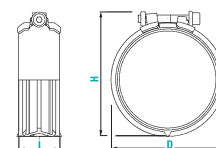

NORMACONNECT® DCS RAPID MSM								
Designation	Max. Dimensions after Assembly ~							W2 Product No.
	DN	D (mm)	H (mm)	L (mm)	P max (bar)	Torque (Nm)	Bolt (mm)	
RAPID DN 50 MSM	50	70	80	40	0.5	Tight-Locking	M 8	0245 8257 050
RAPID DN 70 MSM	70	90	100	40	0.5	Tight-Locking	M 8	0245 8258 070
RAPID DN 80 MSM	75/80	95	105	40	0.5	Tight-Locking	M 8	0245 8260 080
RAPID DN 100 MSM	100	125	135	46	0.5	Tight-Locking	M 8	0245 8261 100
RAPID DN 125 MSM	125	147	162	55	0.5	Tight-Locking	M 8	0245 8262 125
RAPID DN 150 MSM	150	172	187	55	0.5	Tight-Locking	M 8	0245 8263 150
RAPID DN 200 MSM	200	227	244	70	0.5	Tight-Locking	M 10	0245 8264 200

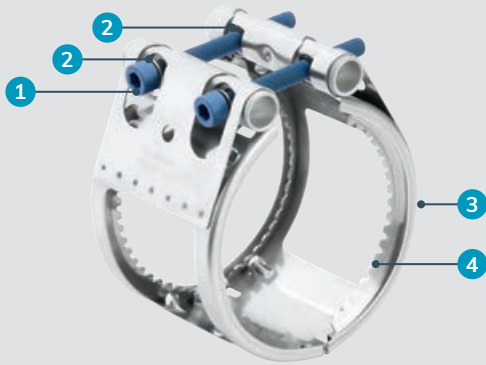

- 1 Hexagonal socket bolts
- 2 Hollow locking bars
- 3 Housing
- 4 Grip ring insert

NORMACONNECT®

The powerful add-on claw

Combined with either DCS RAPID or DCS RAPID MSM standards connectors, our NORMACONNECT® DCS Universal Claw is an axial restraint claw which resists high tensile loads. The grip-type coupling resists high tensile loads for non-pull-out resistant connections.



Materials

W1	W2	W3	W4	W5
	x			

W2

- Material, Housing: AISI 430 Ti
- Material, Closure unit: Steel, surface protected
- Material, Grip ring: AISI 301

Information

Recommended for use in combination with types RAPID/ RAPID MSM: up to max. 10 bar

Technical data & Ordering information

NORMACONNECT® DCS Universal CLAW									
Designation	DN	A (mm)	D (mm)	H (mm)	Bolt (mm)	P max (bar)		Torque (Nm)	W2 Product No.
						RAPID / RAPID MSM			
Universal Claw DN 50	50	77	85	105	M 8	10		Tight-Locking	0262 8401 050
Universal Claw DN 70	70	77	100	120	M 8	10		Tight-Locking	0262 8402 070
Universal Claw DN 75S	75	77	100	120	M 8	10		Tight-Locking	0262 8404 075
Universal Claw DN 80	75/80	77	105	125	M 8	10		Tight-Locking	0262 8403 080
Universal Claw DN 100	100	97	130	150	M 10	10		Tight-Locking	0262 8405 100
Universal Claw DN 125	125	97	165	195	M 10	10		Tight-Locking	0262 8406 125
Universal Claw DN 150	150	97	185	215	M 10	5		Tight-Locking	0262 8407 150
Universal Claw DN 200	200	113	240	270	M 12	5		Tight-Locking	0262 8415 200
Universal Claw DN 250	250	139	305	335	M 12	3		Tight-Locking	0262 8416 250
Universal Claw DN 300	300	139	400	490	M 12	3		Tight-Locking	0262 8417 300

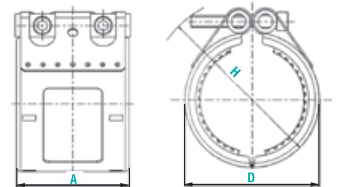

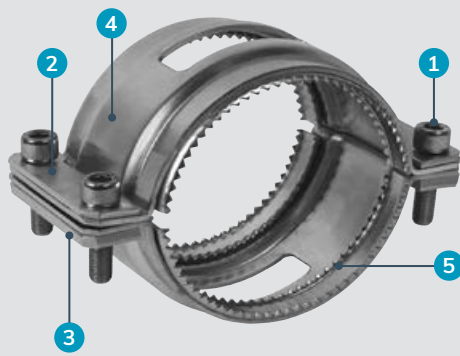

- 1 Hexagonal socket bolt with fine pitch thread
- 2 Guiding plate
- 3 Threaded plate
- 4 Housing
- 5 Grip ring insert (hardened)

The claw which resists high tensile loads

Axial restraint safety claw for use with pressurized pump lines in lifting systems as well as for rainwater sewage lines that are at risk of undergoing back pressures, but only in combination with the NORMACONNECT® DCS RAPID standard connectors. The powerful add-on claw for non-pull-out resistant connections.

Materials

W1	W2	W3	W4	W5
x				

W1

- Material, Housing: Steel, surface protected
- Material, Closure unit: Steel, surface protected

Advantages at a glance

- ✓ Two parts (halves) with hardened grip ring inserts
- ✓ Strong guiding plates with threaded holes plus four hexagonal socket bolts with fine pitch thread

Technical data & Ordering information

NORMACONNECT® DCS RECORD CLAW								
Designation	DN	A (mm)	D (mm)	L (mm)	Torque (Nm)	Bolt (mm)	P max (bar)	W1 Product No.
RECORD Claw DN 50	50	21	75	69	12-15	M 8	up to 10	0262 1265 050
RECORD Claw DN 70	70	21	95	69	12-15	M 8	up to 10	0262 1266 070
RECORD Claw DN 80	75/80	21	100	69	12-15	M 8	up to 10	0262 1287 080
RECORD Claw DN 100	100	25	135	87	25-30	M 10	up to 10	0262 1246 100
RECORD Claw DN 125	125	25	160	95	30-35	M 10	up to 5	0262 1267 125
RECORD Claw DN 150	150	25	185	95	30-35	M 10	up to 5	0262 1268 150
RECORD Claw DN 200	200	30	235	111	60-65	M 12	up to 3	0262 1269 200

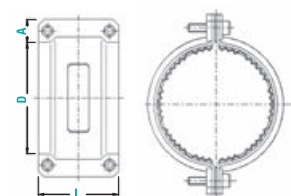

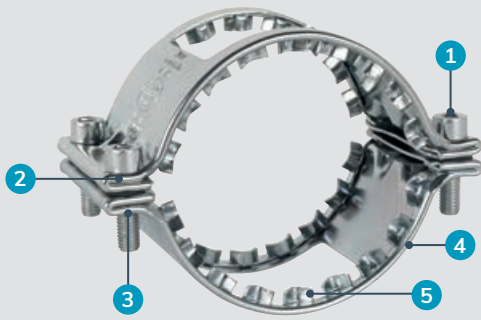

- 1 Hexagonal socket bolts
- 2 Guiding side
- 3 Threaded side
- 4 Housing
- 5 Anchoring teeth

NORMACONNECT®

The claw which resists high tensile loads

Our NORMACONNECT® DCS Combi Claw is an axial restraint safety claw for connecting rainwater and sewage lines that are at risk of undergoing back pressures. It is used in combination with NORMACONNECT® RAPID/RAPID MSM and standard connectors. The powerful add-on claw for non-pull-out resistant connections.

Materials

W1	W2	W3	W4	W5
x				

Information

- Axial restraint up to 10 bar
- Diameters DN 50 up to DN 300

W1

- Material, Housing: Steel, surface protected
- Material, Closure unit: Steel, surface protected

Technical data & Ordering information

NORMACONNECT® DCS COMBI CLAW								
Designation	DN	D (mm)	A (mm)	L (mm)	Torque (Nm)	Bolt (mm)	P max (bar)	W1 Product No.
COMBI Claw DN 50	50	76	18	72	20	M8	up to 10	0262 8590 050
COMBI Claw DN 80	80	99	18	72	20	M8	up to 10	0262 8590 080
COMBI Claw DN 100	100	130	21	82	25	M10	up to 10	0262 8591 100
COMBI Claw DN 125	125	156	21	96	25	M10	up to 8	0262 8592 125
COMBI Claw DN 150	150	180	21	96	25	M10	up to 8	0262 8592 150
COMBI Claw DN 200	200	235	27	110	65	M 12	up to 5	0262 8592 200
COMBI Claw DN 250	250	285	27	130	65	M 12	up to 3	0262 8592 250
COMBI Claw DN 300	300	335	27	130	65	M 12	up to 3	0262 8592 300

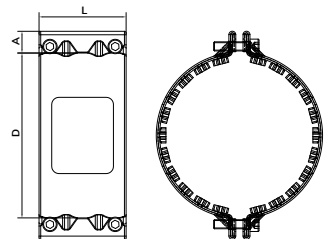



- 1 Easy handling
- 2 Strong worm-drive hose clamp

The changeover connector with 2 lip seals

The NORMACONNECT® CONFIX is a flexible connection which adapts to different pipe dimensions and materials.

Materials

W1	W2	W3	W4	W5
	x			

Material, Connector: EPDM
 Material, Worm-drive hose clamp band: AISI 430

Main advantage

- ✓ The connection of feed or suction lines to a pipe – either made of steel or plastics – is easily and safely achieved with the CONFIX connector.

Technical data & Ordering information

NORMACONNECT® DCS CONFIX, EPDM with TORRO W2, Changeover Connector											
Designation	DN	D1 (mm)	D3 (mm)	D4 (mm)	D5 (mm)	D7 (mm)	L1 (mm)	L3 (mm)	L8 (mm)	Insertion depth (mm)	W2 Product No.
CONFIX DN 50	50	72	56	30	67.5	57	63	19	19	42	0245 9003 050
CONFIX DN 70	70	92	75	41	86.5	77	77	19	24	55	0245 9003 070
CONFIX DN 80 56-75	80	92	75	41	91	81	77	19	24	55	0245 9003 075
CONFIX DN 80 75-90	80	108	90	58	93	81	88	19	23	60	0245 9003 080
CONFIX DN 100	100	128	110	78	118	108	95	21	23	65	0245 9003 100
CONFIX DN 125	125	145	126	90	145	132	103	26	27	75	0245 9003 125

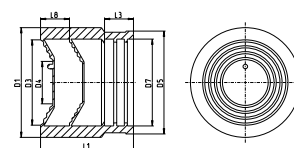

Dimensions of pipes and fittings to EN 877

Dimensions of pipes and fittings to EN 877				
DN	Outside Diameter (OD)		Wall Thickness	
	Nominal value	Tolerances	Nominal value	Minimum value
40	48	+2 -1	3.0	2.5
50	58	+2 -1	3.5	3.0
70	78	+2 -1	3.5	3.0
75/80	83	+2 -1	3.5	3.0
100	110	+2 -1	3.5	3.0
125	135	+2 -2	4.0	3.5
150	160	+2 -2	4.0	3.5
200	210	+2.5 -2.5	5.0	4.0
250	274	+2.5 -2.5	5.5	4.5
300	326	+2.5 -2.5	6.0	5.0
400	429	+2 -3	6.3	5.0
500	532	+2 -3.5	7.0	5.2
600	635	+2 -4	7.7	5.8

Dimensions in mm

NORMA CONNECT®

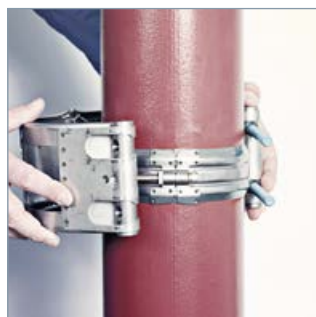

COMPRESSION FITTINGS

NORMA high-performance compression fittings

- ✓ Leakage-free connection for maximum water savings
- ✓ Excellent performance even under harsh conditions
- ✓ Highest durability for better system reliability

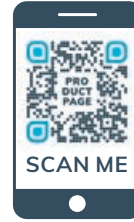

Find all details on our irrigation website:
norma-irrigation.com

NEW

QuickTight Technology
NORMA MARLIN®*



* Up to 50 % faster installations
Drinking water certified

Speed up your water pipe installations with QuickTight Technology!



NORMA MARLIN® PN 16

- Certified for drinking water
- Push fit installation in all sizes
- Faster and easier installation
- Lip-gasket technology for superior performance

More information:
norma-irrigation.com

Save time when repairing a broken pipe!



NORMA® Telescopic Fittings

- Ideal connection for repairing and taping into a PE pipe
- Dual O-rings are used to ensure leakage-free connections
- No additional components required for fixing the pipe
- Extensible telescopic function for easy and fast repair

More information:
norma-irrigation.com

High-performance compression fittings by NORMA



NORMA® PN 16

- Ideal for high-pressure applications
- Perfect water tightness
- Fast and easy connection
- Locking nut for clinching system

More information on
the following pages!

Cost-competitive high-quality compression fittings for your needs



NORMA® PN 10

- No special tooling required
- Easy connection
- High UV and temperature resistance
- Safe and durable

More information:
norma-irrigation.com



- 1 Male threaded adaptor – MA
- 2 Straight coupler – SC
- 3 Female threaded adaptor – FA
- 4 Flange adaptor – FLA
- 5 Equal bend – EB
- 6 Male threaded elbow – MB
- 7 Female threaded elbow – FB
- 8 Male threaded tee – MT
- 9 Female threaded tee – FT



NORMACONNECT®

PN 16 for non-potable water

NORMA® Compression Fittings are made of polypropylene for high-and-low density polyethylene tubing, diameters 16 to 110 mm. Maximum service pressure: PN 16* bar from diameter 16 to diameter 63 – PN 12.5 bar from diameter 75 to diameter 110. DOES NOT INCLUDE hot water application. NORMA® products are made in factories certified under ISO 9001 Version 2008.

Advantages at a glance

- ✓ Safe and durable
- ✓ Fast and easily connected
- ✓ Perfect water tightness
- ✓ Locking nut for a clinching system
- ✓ Simple insertion of the tube in the fitting
- ✓ No special workforce required
- ✓ High resistance to temperature and ultraviolet shocks

Applications

- Watering: Residential, municipal, sport fields, golf courses.
- Irrigation: Agriculture, horticulture, vineyards.
- Industry: Compressed air.



* PN 10 version available in our water management catalogue
Simply download the catalogue here: www.norma-irrigation.com

Information

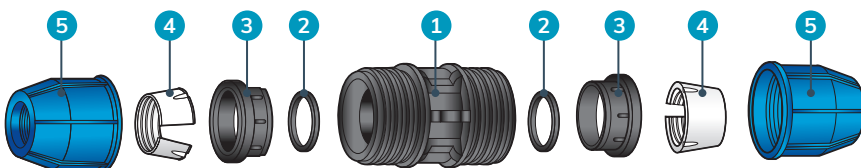

- 1 Body of Polypropylene
- 2 O-ring of NBR
- 3 Holder of Polypropylene
- 4 Clinching Ring of POM, acetal
- 5 Locking nut of Polypropylene

Male threaded adaptor – MA



NORMACONNECT®

Size mm x inch	Designation	Polypropylene homopolymer Product No.
16 x 1/2"	MALE THREADED ADAPTOR (MA) 16 x 1/2"	0796 2601 111
16 x 3/4"	MALE THREADED ADAPTOR (MA) 16 x 3/4"	0796 2601 112
20 x 1/2"	MALE THREADED ADAPTOR (MA) 20 x 1/2"	0796 2651 118
20 x 3/4"	MALE THREADED ADAPTOR (MA) 20 x 3/4"	0796 2651 120
20 x 1"	MALE THREADED ADAPTOR (MA) 20 x 1"	0796 2651 117
25 x 1/2"	MALE THREADED ADAPTOR (MA) 25 x 1/2"	0796 2651 121
25 x 3/4"	MALE THREADED ADAPTOR (MA) 25 x 3/4"	0796 2651 122
25 x 1"	MALE THREADED ADAPTOR (MA) 25 x 1"	0796 2651 124
32 x 1/2"	MALE THREADED ADAPTOR (MA) 32 x 1/2"	0796 2651 126
32 x 3/4"	MALE THREADED ADAPTOR (MA) 32 x 3/4"	0796 2651 127
32 x 1"	MALE THREADED ADAPTOR (MA) 32 x 1"	0796 2651 128
32 x 1 1/4"	MALE THREADED ADAPTOR (MA) 32 x 1 1/4"	0796 2651 130
40 x 3/4"	MALE THREADED ADAPTOR (MA) 40 x 3/4"	0796 2651 131
40 x 1"	MALE THREADED ADAPTOR (MA) 40 x 1"	0796 2651 132
40 x 1 1/4"	MALE THREADED ADAPTOR (MA) 40 x 1 1/4"	0796 2651 133
40 x 1 1/2"	MALE THREADED ADAPTOR (MA) 40 x 1 1/2"	0796 2651 134
50 x 1 1/4"	MALE THREADED ADAPTOR (MA) 50 x 1 1/4"	0796 2651 135
50 x 1 1/2"	MALE THREADED ADAPTOR (MA) 50 x 1 1/2"	0796 2651 136
50 x 2"	MALE THREADED ADAPTOR (MA) 50 x 2"	0796 2651 137
63 x 1 1/2"	MALE THREADED ADAPTOR (MA) 63 x 1 1/2"	0796 2651 138
63 x 2"	MALE THREADED ADAPTOR (MA) 63 x 2"	0796 2651 139
75 x 2"	MALE THREADED ADAPTOR (MA) 75 x 2"	0796 2640 310
75 x 2 1/2"	MALE THREADED ADAPTOR (MA) 75 x 2 1/2"	0796 2640 311
90 x 3"	MALE THREADED ADAPTOR (MA) 90 x 3"	0796 2640 312
110 x 4"	MALE THREADED ADAPTOR (MA) 110 x 4"	0796 2640 313

Female threaded adaptor – FA



Size mm x inch	Designation	Polypropylene homopolymer Product No.
16 x 1/2"	FEMALE THREADED ADAPTOR (FA) 16 x 1/2"	0796 2602 111
16 x 3/4"	FEMALE THREADED ADAPTOR (FA) 16 x 3/4"	0796 2602 112
20 x 1/2"	FEMALE THREADED ADAPTOR (FA) 20 x 1/2"	0796 2651 018
20 x 3/4"	FEMALE THREADED ADAPTOR (FA) 20 x 3/4"	0796 2651 020
25 x 1/2"	FEMALE THREADED ADAPTOR (FA) 25 x 1/2"	0796 2651 022
25 x 3/4"	FEMALE THREADED ADAPTOR (FA) 25 x 3/4"	0796 2651 025
25 x 1"	FEMALE THREADED ADAPTOR (FA) 25 x 1"	0796 2651 028
32 x 3/4"	FEMALE THREADED ADAPTOR (FA) 32 x 3/4"	0796 2651 030
32 x 1"	FEMALE THREADED ADAPTOR (FA) 32 x 1"	0796 2651 033
32 x 1 1/4"	FEMALE THREADED ADAPTOR (FA) 32 x 1 1/4"	0796 2651 035
40 x 1"	FEMALE THREADED ADAPTOR (FA) 40 x 1"	0796 2651 037
40 x 1 1/4"	FEMALE THREADED ADAPTOR (FA) 40 x 1 1/4"	0796 2651 039
40 x 1 1/2"	FEMALE THREADED ADAPTOR (FA) 40 x 1 1/2"	0796 2651 041
50 x 1 1/2"	FEMALE THREADED ADAPTOR (FA) 50 x 1 1/2"	0796 2651 043
50 x 2"	FEMALE THREADED ADAPTOR (FA) 50 x 2"	0796 2651 045
63 x 1 1/2"	FEMALE THREADED ADAPTOR (FA) 63 x 1 1/2"	0796 2651 047
63 x 2"	FEMALE THREADED ADAPTOR (FA) 63 x 2"	0796 2651 049
75 x 2"	FEMALE THREADED ADAPTOR (FA) 75 x 2"	0796 2640 291
75 x 2 1/2"	FEMALE THREADED ADAPTOR (FA) 75 x 2 1/2"	0796 2640 293
90 x 3"	FEMALE THREADED ADAPTOR (FA) 90 x 3"	0796 2640 295
110 x 4"	FEMALE THREADED ADAPTOR (FA) 110 x 4"	0796 2640 297

Male threaded tee – MT



Size mm x inch	Designation	Polypropylene homopolymer Product No.
16 x 1/2"	MALE THREADED TEE (MT) 16 x 1/2"	0796 2603 111
16 x 3/4"	MALE THREADED TEE (MT) 16 x 3/4"	0796 2603 112
20 x 1/2"	MALE THREADED TEE (MT) 20 x 1/2"	0796 2651 154
20 x 3/4"	MALE THREADED TEE (MT) 20 x 3/4"	0796 2651 155
25 x 1/2"	MALE THREADED TEE (MT) 25 x 1/2"	0796 2651 156
25 x 3/4"	MALE THREADED TEE (MT) 25 x 3/4"	0796 2651 157
25 x 1"	MALE THREADED TEE (MT) 25 x 1"	0796 2651 158
32 x 3/4"	MALE THREADED TEE (MT) 32 x 3/4"	0796 2651 159
32 x 1"	MALE THREADED TEE (MT) 32 x 1"	0796 2651 160
40 x 1"	MALE THREADED TEE (MT) 40 x 1"	0796 2651 161
40 x 1 1/4"	MALE THREADED TEE (MT) 40 x 1 1/4"	0796 2651 162
50 x 1 1/4"	MALE THREADED TEE (MT) 50 x 1 1/4"	0796 2651 163
50 x 1 1/2"	MALE THREADED TEE (MT) 50 x 1 1/2"	0796 2651 164
63 x 2"	MALE THREADED TEE (MT) 63 x 2"	0796 2651 165
75 x 2"	MALE THREADED TEE (MT) 75 x 2"	0796 2640 318
75 x 2 1/2"	MALE THREADED TEE (MT) 75 x 2 1/2"	0796 2640 319
90 x 3"	MALE THREADED TEE (MT) 90 x 3"	0796 2640 320
110 x 4"	MALE THREADED TEE (MT) 110 x 4"	0796 2640 321

NORMACONNECT®

Female threaded tee – FT



Size mm x inch	Designation	Polypropylene homopolymer Product No.
16 x 1/2"	FEMALE THREADED TEE (FT) 16 x 1/2"	0796 2604 111
16 x 3/4"	FEMALE THREADED TEE (FT) 16 x 3/4"	0796 2604 112
20 x 1/2"	FEMALE THREADED TEE (FT) 20 x 1/2"	0796 2651 088
20 x 3/4"	FEMALE THREADED TEE (FT) 20 x 3/4"	0796 2651 090
25 x 1/2"	FEMALE THREADED TEE (FT) 25 x 1/2"	0796 2651 092
25 x 3/4"	FEMALE THREADED TEE (FT) 25 x 3/4"	0796 2651 094
25 x 1"	FEMALE THREADED TEE (FT) 25 x 1"	0796 2651 096
32 x 3/4"	FEMALE THREADED TEE (FT) 32 x 3/4"	0796 2651 098
32 x 1"	FEMALE THREADED TEE (FT) 32 x 1"	0796 2651 100
32 x 1 1/4"	FEMALE THREADED TEE (FT) 32 x 1 1/4"	0796 2651 102
40 x 1"	FEMALE THREADED TEE (FT) 40 x 1"	0796 2651 104
40 x 1 1/4"	FEMALE THREADED TEE (FT) 40 x 1 1/4"	0796 2651 106
40 x 1 1/2"	FEMALE THREADED TEE (FT) 40 x 1 1/2"	0796 2651 108
50 x 1 1/2"	FEMALE THREADED TEE (FT) 50 x 1 1/2"	0796 2651 110
50 x 2"	FEMALE THREADED TEE (FT) 50 x 2"	0796 2651 112
63 x 1 1/2"	FEMALE THREADED TEE (FT) 63 x 1 1/2"	0796 2651 114
63 x 2"	FEMALE THREADED TEE (FT) 63 x 2"	0796 2651 116
75 x 2 1/2"	FEMALE THREADED TEE (FT) 75 x 2 1/2"	0796 2640 305
90 x 3"	FEMALE THREADED TEE (FT) 90 x 3"	0796 2640 307
110 x 4"	FEMALE THREADED TEE (FT) 110 x 4"	0796 2640 309

COMPRESSION FITTINGS

Male threaded elbow – MB



Size mm x inch	Designation	Polypropylene homopolymer Product No.
16 x 1/2"	MALE THREADED ELBOW (MB) 16 x 1/2"	0796 2605 111
16 x 3/4"	MALE THREADED ELBOW (MB) 16 x 3/4"	0796 2605 112
20 x 1/2"	MALE THREADED ELBOW - MALE BEND 90 (MB) 20 x 1/2"	0796 2651 140
20 x 3/4"	MALE THREADED ELBOW - MALE BEND 90 (MB) 20 x 3/4"	0796 2651 141
25 x 1/2"	MALE THREADED ELBOW - MALE BEND 90 (MB) 25 x 1/2"	0796 2651 142
25 x 3/4"	MALE THREADED ELBOW - MALE BEND 90 (MB) 25 x 3/4"	0796 2651 143
25 x 1"	MALE THREADED ELBOW - MALE BEND 90 (MB) 25 x 1"	0796 2651 144
32 x 3/4"	MALE THREADED ELBOW - MALE BEND 90 (MB) 32 x 3/4"	0796 2651 145
32 x 1"	MALE THREADED ELBOW - MALE BEND 90 (MB) 32 x 1"	0796 2651 146
40 x 1"	MALE THREADED ELBOW - MALE BEND 90 (MB) 40 x 1"	0796 2651 147
40 x 1 1/4"	MALE THREADED ELBOW - MALE BEND 90 (MB) 40 x 1 1/4"	0796 2651 148
40 x 1 1/2"	MALE THREADED ELBOW - MALE BEND 90 (MB) 40 x 1 1/2"	0796 2651 149
50 x 1 1/4"	MALE THREADED ELBOW - MALE BEND 90 (MB) 50 x 1 1/4"	0796 2651 150
50 x 1 1/2"	MALE THREADED ELBOW - MALE BEND 90 (MB) 50 x 1 1/2"	0796 2651 151
50 x 2"	MALE THREADED ELBOW - MALE BEND 90 (MB) 63 x 2"	0796 2651 152
63 x 2"	MALE THREADED ELBOW - MALE BEND 90 (MB) 63 x 2"	0796 2651 153
75 x 2"	MALE THREADED ELBOW - MALE BEND 90 (MB) 75 x 2"	0796 2640 314
75 x 2 1/2"	MALE THREADED ELBOW - MALE BEND 90 (MB) 75 x 2 1/2"	0796 2640 315
90 x 3"	MALE THREADED ELBOW - MALE BEND 90 (MB) 90 x 3"	0796 2640 316
110 x 4"	MALE THREADED ELBOW - MALE BEND 90 (MB) 110 x 4"	0796 2640 317

NORMACONNECT®

Female threaded elbow – FB



Size mm x inch	Designation	Polypropylene homopolymer Product No.
16 x 1/2"	FEMALE THREADED ELBOW (FB) 16 x 1/2"	0796 2606 111
16 x 3/4"	FEMALE THREADED ELBOW (FB) 16 x 3/4"	0796 2606 112
20 x 1/2"	FEMALE THREADED ELBOW - FEMALE BEND 90 (FB) 20 x 1/2"	0796 2651 051
20 x 3/4"	FEMALE THREADED ELBOW - FEMALE BEND 90 (FB) 20 x 3/4"	0796 2651 054
25 x 1/2"	FEMALE THREADED ELBOW - FEMALE BEND 90 (FB) 25 x 1/2"	0796 2651 056
25 x 3/4"	FEMALE THREADED ELBOW - FEMALE BEND 90 (FB) 25 x 3/4"	0796 2651 059
25 x 1"	FEMALE THREADED ELBOW - FEMALE BEND 90 (FB) 25 x 1"	0796 2651 061
32 x 1/2"	FEMALE THREADED ELBOW - FEMALE BEND 90 (FB) 32 x 1/2"	0796 2651 063
32 x 3/4"	FEMALE THREADED ELBOW - FEMALE BEND 90 (FB) 32 x 3/4"	0796 2651 065
32 x 1"	FEMALE THREADED ELBOW - FEMALE BEND 90 (FB) 32 x 1"	0796 2651 068
32 x 1 1/4"	FEMALE THREADED ELBOW - FEMALE BEND 90 (FB) 32 x 1 1/4"	0796 2651 070
40 x 1"	FEMALE THREADED ELBOW - FEMALE BEND 90 (FB) 40 x 1"	0796 2651 072
40 x 1 1/4"	FEMALE THREADED ELBOW - FEMALE BEND 90 (FB) 40 x 1 1/4"	0796 2651 074
40 x 1 1/2"	FEMALE THREADED ELBOW - FEMALE BEND 90 (FB) 40 x 1 1/2"	0796 2651 076
50 x 1 1/4"	FEMALE THREADED ELBOW - FEMALE BEND 90 (FB) 50 x 1 1/4"	0796 2651 078
50 x 1 1/2"	FEMALE THREADED ELBOW - FEMALE BEND 90 (FB) 50 x 1 1/2"	0796 2651 080
50 x 2"	FEMALE THREADED ELBOW - FEMALE BEND 90 (FB) 50 x 2"	0796 2651 082
63 x 1 1/2"	FEMALE THREADED ELBOW - FEMALE BEND 90 (FB) 63 x 1 1/2"	0796 2651 084
63 x 2"	FEMALE THREADED ELBOW - FEMALE BEND 90 (FB) 63 x 2"	0796 2651 086
75 x 2 1/2"	FEMALE THREADED ELBOW - FEMALE BEND 90 (FB) 75 x 2 1/2"	0796 2640 299
90 x 3"	FEMALE THREADED ELBOW - FEMALE BEND 90 (FB) 90 x 3"	0796 2640 301
110 x 4"	FEMALE THREADED ELBOW - FEMALE BEND 90 (FB) 110 x 4"	0796 2640 303

Straight coupler – SC



Size mm	Designation	Polypropylene homopolymer Product No.
16	STRAIGHT COUPLER (SC) 16	0796 2607 111
20	STRAIGHT COUPLER (SC) 20	0796 2651 191
25	STRAIGHT COUPLER (SC) 25	0796 2651 192
32	STRAIGHT COUPLER (SC) 32	0796 2651 193
40	STRAIGHT COUPLER (SC) 40	0796 2651 194
50	STRAIGHT COUPLER (SC) 50	0796 2651 195
63	STRAIGHT COUPLER (SC) 63	0796 2651 196
75	STRAIGHT COUPLER (SC) 75	0796 2640 334
90	STRAIGHT COUPLER (SC) 90	0796 2640 335
110	STRAIGHT COUPLER (SC) 110	0796 2640 336

Equal bend – EB



Size mm	Designation	Polypropylene homopolymer Product No.
16	EQUAL BEND (EB) 16	0796 2608 111
20	EQUAL BEND (EB) 20	0796 2650 998
25	EQUAL BEND (EB) 25	0796 2650 999
32	EQUAL BEND (EB) 32	0796 2651 000
40	EQUAL BEND (EB) 40	0796 2651 001
50	EQUAL BEND (EB) 50	0796 2651 002
63	EQUAL BEND (EB) 63	0796 2651 003
75	EQUAL BEND (EB) 75	0796 2640 281
90	EQUAL BEND (EB) 90	0796 2640 282
110	EQUAL BEND (EB) 110	0796 2640 283

Equal tee – ET



Size mm	Designation	Polypropylene homopolymer Product No.
16	EQUAL TEE (ET) 16	0796 2609 111
20	EQUAL TEE (ET) 20	0796 2651 010
25	EQUAL TEE (ET) 25	0796 2651 011
32	EQUAL TEE (ET) 32	0796 2651 012
40	EQUAL TEE (ET) 40	0796 2651 013
50	EQUAL TEE (ET) 50	0796 2651 014
63	EQUAL TEE (ET) 63	0796 2651 015
75	EQUAL TEE (ET) 75	0796 2640 287
90	EQUAL TEE (ET) 90	0796 2640 288
110	EQUAL TEE (ET) 110	0796 2640 289

End cap – EC



Size mm	Designation	Polypropylene homopolymer Product No.
16	END CAP (EC) 16	0796 2610 111
20	END CAP (EC) 20	0796 2651 004
25	END CAP (EC) 25	0796 2651 005
32	END CAP (EC) 32	0796 2651 006
40	END CAP (EC) 40	0796 2651 007
50	END CAP (EC) 50	0796 2651 008
63	END CAP (EC) 63	0796 2651 009
75	END CAP (EC) 75	0796 2640 284
90	END CAP (EC) 90	0796 2640 285
110	END CAP (EC) 110	0796 2640 286

COMPRESSION FITTINGS

Reducing coupler – RC



Size mm x inch	Designation	Polypropylene homopolymer Product No.
25 x 20"	REDUCING COUPLER (RC) 25 x 20"	0796 2651 166
32 x 20"	REDUCING COUPLER (RC) 32 x 20"	0796 2651 167
32 x 25"	REDUCING COUPLER (RC) 32 x 25"	0796 2651 168
40 x 20"	REDUCING COUPLER (RC) 40 x 20"	0796 2651 169
40 x 25"	REDUCING COUPLER (RC) 40 x 25"	0796 2651 170
40 x 32"	REDUCING COUPLER (RC) 40 x 32"	0796 2651 171
50 x 20"	REDUCING COUPLER (RC) 50 x 20"	0796 2651 172
50 x 25"	REDUCING COUPLER (RC) 50 x 25"	0796 2651 173
50 x 32"	REDUCING COUPLER (RC) 50 x 32"	0796 2651 174
50 x 40"	REDUCING COUPLER (RC) 50 x 40"	0796 2651 175
63 x 25"	REDUCING COUPLER (RC) 63 x 25"	0796 2651 176
63 x 32"	REDUCING COUPLER (RC) 63 x 32"	0796 2651 177
63 x 40"	REDUCING COUPLER (RC) 63 x 40"	0796 2651 178
63 x 50"	REDUCING COUPLER (RC) 63 x 50"	0796 2651 179
75 x 40"	REDUCING COUPLER (RC) 75 x 40"	0796 2640 322
75 x 50"	REDUCING COUPLER (RC) 75 x 50"	0796 2640 323
75 x 63"	REDUCING COUPLER (RC) 75 x 63"	0796 2640 324
90 x 63"	REDUCING COUPLER (RC) 90 x 63"	0796 2640 325
90 x 75"	REDUCING COUPLER (RC) 90 x 75"	0796 2640 326
110 x 90"	REDUCING COUPLER (RC) 110 x 90"	0796 2640 327

Reducing tee – RT



Size mm x inch	Designation	Polypropylene homopolymer Product No.
25 x 20"	REDUCING TEE (RT) 25 x 20"	0796 2651 180
32 x 20"	REDUCING TEE (RT) 32 x 20"	0796 2651 181
32 x 25"	REDUCING TEE (RT) 32 x 25"	0796 2651 182
40 x 25"	REDUCING TEE (RT) 40 x 25"	0796 2651 183
40 x 32"	REDUCING TEE (RT) 40 x 32"	0796 2651 184
50 x 25"	REDUCING TEE (RT) 50 x 25"	0796 2651 185
50 x 32"	REDUCING TEE (RT) 50 x 32"	0796 2651 186
50 x 40"	REDUCING TEE (RT) 50 x 40"	0796 2651 187
63 x 32"	REDUCING TEE (RT) 63 x 32"	0796 2651 188
63 x 40"	REDUCING TEE (RT) 63 x 40"	0796 2651 189
63 x 50"	REDUCING TEE (RT) 63 x 50"	0796 2651 190
75 x 40"	REDUCING TEE (RT) 75 x 40"	0796 2640 328
75 x 50"	REDUCING TEE (RT) 75 x 50"	0796 2640 329
75 x 63"	REDUCING TEE (RT) 75 x 63"	0796 2640 330
90 x 63"	REDUCING TEE (RT) 90 x 63"	0796 2640 331
90 x 75"	REDUCING TEE (RT) 90 x 75"	0796 2640 332
110 x 90"	REDUCING TEE (RT) 110 x 90"	0796 2640 333

Flange adaptor – FLA



Size mm x mm	Designation	Polypropylene homopolymer Product No.
63 x 50DN	FLANGE ADAPTOR (FLA) 63 x 50DN	0796 2600 004
90 x 80DN	FLANGE ADAPTOR (FLA) 90 x 80DN	0796 2600 005
110 x 100DN	FLANGE ADAPTOR (FLA) 110 x 100DN	0796 2600 006

Pop-up Equal bend – PE



Size mm x inch	Designation	Polypropylene homopolymer Product No.
20 x 1/2"	POP-UP EQUAL BEND (PE) 20 x 1/2"	0796 2030 181
25 x 1/2"	POP-UP EQUAL BEND (PE) 25 x 1/2"	0796 2030 182
32 x 3/4"	POP-UP EQUAL BEND (PE) 32 x 3/4"	0796 2030 183

Wall plate elbow – WPE



Size mm x inch	Designation	Polypropylene homopolymer Product No.
25 x 3/4"	WALL PLATE ELBOW (WPE) 25 x 3/4"	0796 2030 360

Male threaded adaptor with brass insert – MAB



Size mm x inch	Designation	Polypropylene homopolymer Product No.
20 x 1/2"	MALE THREADED ADAPTOR WITH BRASS INSERT (MAB) 20 x 1/2"	0796 2651 119
25 x 3/4"	MALE THREADED ADAPTOR WITH BRASS INSERT (MAB) 25 x 3/4"	0796 2651 123
25 x 1"	MALE THREADED ADAPTOR WITH BRASS INSERT (MAB) 25 x 1"	0796 2651 125
32 x 1"	MALE THREADED ADAPTOR WITH BRASS INSERT (MAB) 32 x 1"	0796 2651 129

Female threaded adaptor with brass insert – FAB



Size mm x inch	Designation	Polypropylene homopolymer Product No.
20 x 1/2"	FEMALE THREADED ADAPTOR WITH BRASS INSERT (FAB) 20 x 1/2"	0796 2651 017
25 x 3/4"	FEMALE THREADED ADAPTOR WITH BRASS INSERT (FAB) 25 x 3/4"	0796 2651 024
25 x 1"	FEMALE THREADED ADAPTOR WITH BRASS INSERT (FAB) 25 x 1"	0796 2651 027
32 x 1"	FEMALE THREADED ADAPTOR WITH BRASS INSERT (FAB) 32 x 1"	0796 2651 032

Female threaded bend with brass insert – FBB



Size mm x inch	Designation	Polypropylene homopolymer Product No.
20 x 3/4"	FEMALE THREADED BEND WITH BRASS INSERT (FBB) 20 x 3/4"	0796 2651 053
25 x 3/4"	FEMALE THREADED BEND WITH BRASS INSERT (FBB) 25 x 3/4"	0796 2651 058
32 x 1"	FEMALE THREADED BEND WITH BRASS INSERT (FBB) 32 x 1"	0796 2651 067

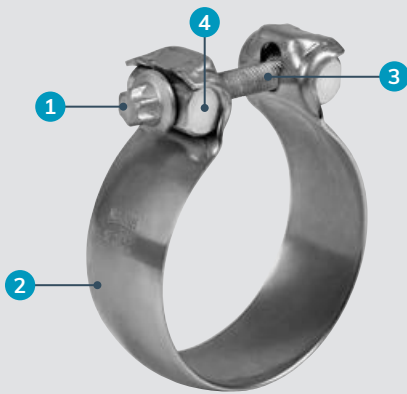

- 1 Torx screw with integrated washer**
- makes installation and removal easier
- 2 Band adapted to fit ball-shaped flange connections**
- system works in perfect harmony
- 3 Free from chromium (VI); easy-slide coating**
- improved clamping force
- 4 Solid trunnion, chromium (VI)-free coating**
- high temperature resistance, maintains high clamping force levels

NORMACONNECT®

Ball-flare connection of exhaust pipes

NORMACONNECT® SEC is the ideal solution when it comes to making connections in central and rear sections of vehicle exhaust systems. When used in conjunction with flange joints, it is possible to swivel exhaust pipes during installation.

Advantages at a glance

- ✔ Allows/compensates for angular deflection of pipe up to $\pm 3^\circ$
- ✔ Exhaust pipes can be swiveled during installation
- ✔ Installation and removal conditions easier to work with thanks to increased flexibility of overall system
- ✔ Low weight and low leakage rate

Applications

For low leak joints in rear and centre sections of car and truck exhaust systems with operating clamp surface temperatures of up to 700 °C.

Materials

W1	W2	W3	W4	W5
	x			

Material	Corrosion resistance in salt spray testing
W2	Min. 96 h

Technical data & Ordering information

NORMACONNECT® SEC					
Designation	Pipe diameter inner		Clamping diameter in mm	Flange radius in mm	W2 Product No.
	in mm	in inches			
SEC 55	55	2 3/16"	65	32.5	0595 6312 055-1
SEC 60	60	2 3/8"	69.5	34.8	0595 5312 060-1
SEC 65	65	2 9/16"	75	37.6	0595 5312 065-1
SEC 70	70	2 3/4"	81.5	40.2	0595 6312 070-1
SEC 75	75	2 20/21"	87	42.5	0595 6342 075

Additional diameters on request

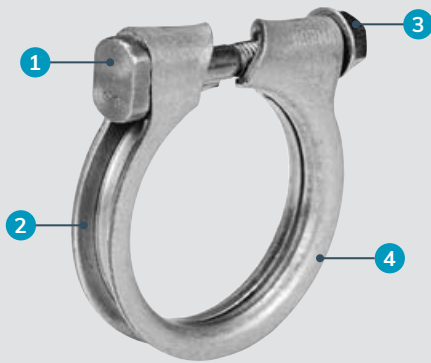

- 1** M8, M10 & M12 bolts available as alternatives
- depending on clamping force requirements
- 2** Clamp band in one piece
- contact surface meets pipe consistently
- even contact pressure over the entire pipe circumference
- excellent sealing properties
- 3** Single-bolt closure
- easy installation
- 4** Rounded band edges
- pipe protection
- prevents risk of injuries

Exhaust pipe clamps

NORMACONNECT® ARS exhaust pipe clamps provide a secure, reliable connection for pipes that are fitted into one another, even those that are subject to significant temperature fluctuations. As such, they are particularly suitable for connecting exhaust pipes and silencers in the automotive industry.

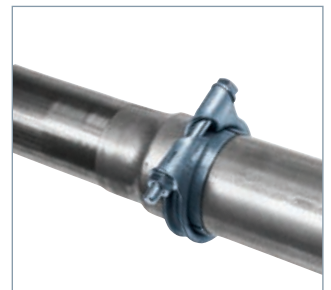

Advantages at a glance

- ✓ One piece
- ✓ Contact surface meets pipe consistently
- ✓ Even contact pressure over entire pipe circumference
- ✓ No risk of asymmetrical pipe deformation

Applications

- Agricultural machines
- Building machines
- Engine manufacturing

Materials

W1	W2	W3	W4	W5
x	x*		x*	x*

* On request.

Material	Corrosion resistance in salt spray testing
W1	Min. 144 h

Bolts

Bolt	Hammer head bolt/Flange nut	Hexagon-head bolt/Flange nut	Hexagon-head bolt/Hexagon	Loose washer*
M8	x	x		x**
M10			x	x
M12			x	x

* Under bolt head and under bolt nut.

** Under bolt head (select nominal diameters only).

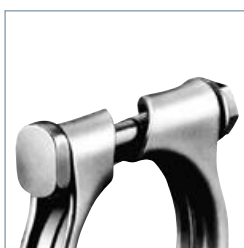

M8 version with hammer head bolt.

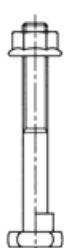

M10 and M12 version with hexagon-head bolt.

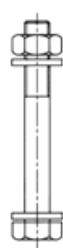

Technical data & Ordering information

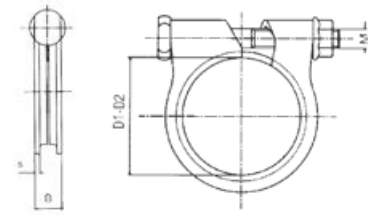

NORMACONNECT®

NORMACONNECT® ARS					
Designation	Clamping ranges D1-D2 in mm	S	B	Recommended tightening torque	W1 Product No.
ARS-M8-27	24-27	1.5	10.4	8 – 10 Nm	0151 8939 027
ARS-M8-33	30-33	1.5	10.4		0151 8939 033
ARS-M8-36	33-36	2.0	12.8	10 – 15 Nm	0151 8940 036
ARS-M8-39.5	36.5-39.5	2.0	12.0		0151 8940 040
ARS-M8-42	39-42	2.0	12.8		0151 8940 042
ARS-M8-45	42-45	2.5	13.6	15 – 20 Nm	0151 8941 045
ARS-M8-46	43-46	2.5	12.8		0151 8941 046
ARS-M8-47	44-47	2.5	13.6		0151 8941 047
ARS-M8-48	45-49	2.5	13.2		0151 8941 048
ARS-M8-49	45-49	2.5	13.2		0151 8941 049
ARS-M8-50.5	51-54	2.5	13.2		0151 8941 505
ARS-M8-51	48-51	2.5	13.2		0151 8941 051
ARS-M8-54	51-54	2.5	13.2		0151 8941 054
ARS-M8-55	52-55	2.5	13.6		0151 8941 055
ARS-M8-58	55-58	2.5	13.2		0151 8941 058
ARS-M8-64	61-64	2.5	13.2		0151 8941 064
ARS-M8-66	63-66	2.5	13.2		0151 8941 066
ARS-M8-71	68-71	2.5	13.2	0151 8941 071	

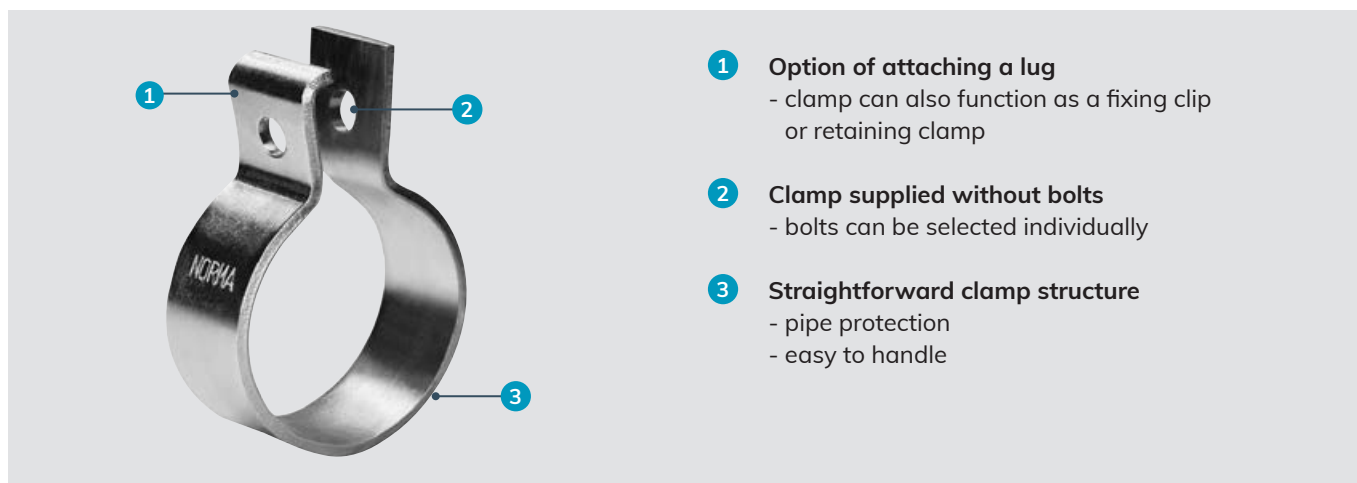

- 1 **Option of attaching a lug**
- clamp can also function as a fixing clip or retaining clamp
- 2 **Clamp supplied without bolts**
- bolts can be selected individually
- 3 **Straightforward clamp structure**
- pipe protection
- easy to handle

Exhaust pipe clamps in accordance with DIN 71555

NORMACONNECT® RS/DIN exhaust pipe clamps are an alternative to NORMACONNECT® ARS clamps. They ensure an equally secure connection for pipes that are fitted into one another. Additionally, the straight-forward clamp structure of the RS/DIN version allows a lug to be attached to it, meaning that it can also be used as a fixing clip.



Advantages at a glance

- ✓ Safe system for connecting pipes that are fitted to one another
- ✓ Can also be used as a fixing clip or retaining clamp
- ✓ In accordance with DIN 71555

Applications

- Agricultural machines
- Building machines
- Engine manufacturing

Materials

W1	W2	W3	W4	W5
x		x*	x*	x*

* On request.

Material	Corrosion resistance in salt spray testing
W1	Min. 144 h

Bolts

The scope of delivery does not include fastening bolts or nuts. Sizes M8 or M10 are required.

Technical data & Ordering information

NORMACONNECT® RS/DIN			
Band width	Designation	Clamping diameter in mm	W1 Product No.
20	RS 30.2 DIN 71555	30.2	0550 7000 030
	RS 32.2 DIN 71555	32.2	0550 7000 032
	RS 35.2 DIN 71555	35.2	0550 7000 035
	RS 37.2 DIN 71555	37.2	0550 7000 037
25	RS 40.3 DIN 71555	40.3	0550 7000 040
	RS 42.3 DIN 71555	42.3	0550 7000 042
	RS 45.5 DIN 71555	45.5	0550 7000 045
	RS 48.5 DIN 71555	48.5	0550 7000 048
	RS 50.5 DIN 71555	50.5	0550 7000 050
	RS 53.5 DIN 71555	53.5	0550 7000 053
	RS 55.5 DIN 71555	55.5	0550 7000 055
	RS 58.5 DIN 71555	58.5	0550 7000 058
	RS 60.5 DIN 71555	60.5	0550 7000 060
	RS 63.5 DIN 71555	63.5	0550 7000 063
	RS 65.5 DIN 71555	65.5	0550 7000 065
	RS 68.5 DIN 71555	68.5	0550 7000 068
30	RS 70.5 DIN 71555	70.5	0550 7000 070
	RS 73.5 DIN 71555	73.5	0550 7000 073
	RS 75.5 DIN 71555	75.5	0550 7000 075
	RS 78.5 DIN 71555	78.5	0550 7000 078
	RS 85.5 DIN 71555	85.5	0550 7000 085
	RS 89.5 DIN 71555	89.5	0550 7000 089
	RS 90.5 DIN 71555	90.5	0550 7000 090
	RS 94.5 DIN 71555	94.5	0550 7000 094
	RS 100.5 DIN 71555	100.5	0550 7000 100
	RS 104.5 DIN 71555	104.5	0550 7000 104
	RS 110.5 DIN 71555	110.5	0550 7000 110



- 1 High-strength fastener hardware
- 2 Easy to assemble
- 3 Reaction block serves as a defined stop, avoiding pipe deformation

NORMACONNECT®

High-performance clamp for joining two overlapping exhaust pipes

The NORMACONNECT® AccuSeal offers an innovative reaction block technology to provide a full 360 degree equal distribution of clamping force, prohibiting pipe distortion while completing a unique seal around the joined exhaust components with high clamp load.



Advantages at a glance

- ✓ Durable installation without damaging the pipe ends
- ✓ 360° equal distribution of clamping force
- ✓ Exhaust connections are serviceable and easy to disassemble
- ✓ Clamp available in different materials to cover a broad range of exhaust pipes
- ✓ Low weight and low leakage rate

Applications

AccuSeal clamps are used to join two overlapping exhaust pipes in rear and center sections of passenger and commercial vehicles. Recommended for pipes with wall thickness between 1.2 and 1.6 mm.

Materials

W1	W2	W3	W4	W5
x		x	x	

Technical data & Ordering information

- Assembly torque: 55 +/- 8 Nm
- Maximum pipe surface temperature: 600 °C

NORMACONNECT® ACCUSEAL				
Designation	Clamp diameter in delivery condition in mm	W1 Product No.	W3 Product No.	W4 Product No.
AccuSeal 476	47.6		0366 6100 476	
AccuSeal 506	50.6		0366 6100 506	0366 6120 506
AccuSeal 520	52.0		0366 6100 520	
AccuSeal 549	54.9		0366 6100 549	
AccuSeal 556	55.6			0366 6120 556
AccuSeal 564	56.4	0366 6100 564	0366 6110 564	
AccuSeal 606	60.6		0366 6110 606	0366 6120 606
AccuSeal 626	62.6			0366 6110 626
AccuSeal 629	62.9	0366 6100 629	0366 6120 629	
AccuSeal 649	64.9		0366 6110 649	
AccuSeal 656	65.6	0366 6100 656	0366 6110 656	0366 6120 656
AccuSeal 689	68.9	0366 6100 689		
AccuSeal 691	69.1		0366 6100 691	
AccuSeal 706	70.6	0366 6110 706	0366 6120 706	0366 6130 706
AccuSeal 756	75.6		0366 6000 756	0366 6100 756
AccuSeal 816	81.6			0366 6100 816
AccuSeal 818	81.8		0366 6120 818	
AccuSeal 949	94.9	0366 6100 949	0366 6110 949	
AccuSeal 1072	107.2	0366 6121 072	0366 6111 072	
AccuSeal 1326	132.6		0366 6101 326	
AccuSeal 1327	132.7			0366 6001 327
AccuSeal 1582	158.2	0366 6101 582	0366 6111 582	



- 1 Provides OE with a robust design alternative to flat flange
- 2 Provides rotational and axial alignment flexibility

Robust alternative clamp

The NORMACONNECT® AccuLock exhaust clamp provides a robust alternative to flat flanges with enhanced assembly flexibility, lower weight and improved overall value. Designed for use in low leak, pre- and after-treatment (catalyst) applications. Uses less space than a flat flange joint and has positive axial retention.

Advantages at a glance

- ✓ Enhanced assembly flexibility, lower weight, improved overall value
- ✓ Positive axial retention
- ✓ Uses less space than a flat flange joint

Applications

Designed for use in low leak, pre- and after-treatment (catalyst) applications

Materials

- Aluminized steel
- 409 stainless steel
- 430 stainless steel

Information

Available in standard industry sizes from 55 mm (2 1/5") up to 387.6 mm (15 1/3")

Technical data & Ordering information

NORMACONNECT® ACCULOCK			
Designation	Diameters		Aluminized Steel Product No.
	in mm	in inches	
ACCULOCK 55	55	2 1/5"	0370 0000 055
ACCULOCK 63.5	63.5	2 1/2"	0370 0001 064
ACCULOCK 88.9	88.9	3 1/2"	0370 0002 089

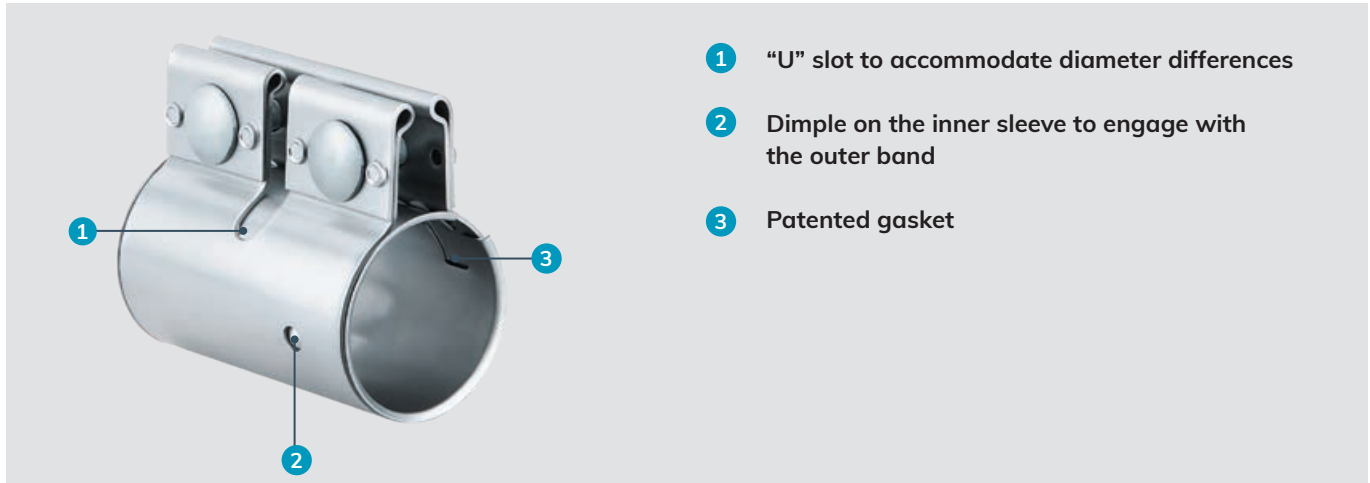

- 1 "U" slot to accommodate diameter differences
- 2 Dimple on the inner sleeve to engage with the outer band
- 3 Patented gasket

Joining exhaust system components

The NORMACONNECT® EuroCoupler is an effective way to join exhaust system components without the need for pipe flares/slip joints or slotting. This clamp offers superior clamp load capability and a serviceable joint. Allows for quick assembly and service of exhaust pipes. It provides significant resistance to longitudinal and rotational movement of pipes.

Advantages at a glance

- ✓ No need for pipe sizing or slotting
- ✓ Patented gasket with proven sealing ability to reduce leak rates
- ✓ Preassembled unit – easy, reliable installation
- ✓ Superior clamp load capability

Applications

Effective way to join pipe to pipe connections of same diameter in an exhaust system.

Materials

W1	W2	W3	W4	W5
		x		

Technical data & Ordering information

NORMACONNECT® EUROCOUPLER			
Width in mm	Designation	Nominal diameter	W3 Product No.
		in mm	
88.7	EUROCOUPLER 40-441/88	40	0367 6005 040
	EUROCOUPLER 45-441/88	45	0367 6009 045
	EUROCOUPLER 50-441/88	50	0367 6010 050
	EUROCOUPLER 55-441/88	55	0367 6008 055
	EUROCOUPLER 60-441/88	60	0367 6011 060
	EUROCOUPLER 65-441/88	65	0367 6022 065
	EUROCOUPLER 70-441/88	70	0367 6033 070



1 Pre-mounted screw and nuts

Exhaust system pipe clamp

The NORMACONNECT® Pipe Clamp M8/M10 meets quality standards, which are suitable for use with a wide range of pipe diameters. Pipe clamps are not only used in exhaust systems.

Advantages at a glance

- ✓ Hexagonal wheel for better maintenance of the U
- ✓ Completely assembled
- ✓ Suitable for use with a wide range of pipe diameters

Applications

- Exhaust systems
- Mounting of signage
- TV antennas/aerials

Materials

W1	W2	W3	W4	W5
x			x	

Technical data & Ordering information

NORMACONNECT® PIPE CLAMP M8/M10			
Designation	Diameter in mm	W1 Product No.	W4 Product No.
PIPE CLAMP M8 32	32	08937481032	08937411032
PIPE CLAMP M8 35	35	08937481035	08937411035
PIPE CLAMP M8 38	38	08937481038	08937411038
PIPE CLAMP M8 40	40	08937481040	08937411040
PIPE CLAMP M8 42	42	08937481042	08937411042
PIPE CLAMP M8 44	44	08937481044	08937411044
PIPE CLAMP M8 45	45	08937481045	08937411045
PIPE CLAMP M8 48	48	08937481048	08937411048
PIPE CLAMP M8 52	52	08937481052	08937411052
PIPE CLAMP M8 54	54	08937481054	08937411054
PIPE CLAMP M8 57	57	08937481057	08937411057
PIPE CLAMP M8 60	60	08937481060	08937411060
PIPE CLAMP M8 65	65	08937481065	08937411065
PIPE CLAMP M8 70	70	08937481070	08937411070
PIPE CLAMP M8 76	76	08937481076	08937411076
PIPE CLAMP M10 90	90	08937481090	
PIPE CLAMP M10 115	115	08937481115	
PIPE CLAMP M10 127	127	08937481127	
PIPE CLAMP M10 140	140	08937481140	

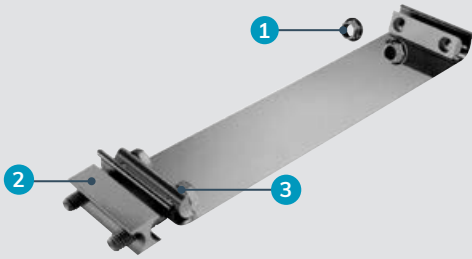

- 1 High-strength, plated grade 8 fasteners
- 2 The original invented reaction block technology creates a complete “inner circle seal” when clamp is secured
- 3 Pre-attached hardware for fast, easy and accurate installation

NORMACONNECT®

Wide band exhaust clamps

The NORMACONNECT® EasySeal offers the best value in wideband exhaust clamps. Used for joining overlapping exhaust members. The unique design makes for fast, easy and accurate installation.

Advantages at a glance

- ✓ Unique design makes for fast, easy and accurate installation – there’s no need to separate pipes or exhaust members before clamping
- ✓ Replaces U-bolts and clamps
- ✓ With pre-attached hardware
- ✓ Ideal, service specific design
- ✓ Flat, packaged, easy to store
- ✓ Easy, fast, accurate installation
- ✓ Unique sealing performance
Durable installation without damage to pipe ends

Materials

304 Stainless steel

Applications

To connect exhaust system components

Information

Available in standard industry sizes from 50.8 mm (2") up to 203.2 mm (8")

Technical data & Ordering information

NORMACONNECT® EASYSEAL			
Designation	Diameters		304 Stainless Steel Product No.
	in mm	in inches	
EASYSEAL 50.8	50.8	2"	0368 6000 051
EASYSEAL 57.15	57.15	2 1/4"	0368 6000 056
EASYSEAL 63.5	63.5	2 1/2"	0368 6000 064
EASYSEAL 69.85	69.85	2 3/4"	0368 6000 069
EASYSEAL 76.2	76.2	3"	0368 6000 076
EASYSEAL 88.9	88.9	3 1/2"	0368 6000 089
EASYSEAL 101.6	101.6	4"	0368 6000 102
EASYSEAL 114.3	114.3	5"	0368 6000 114
EASYSEAL 127	127	5"	0368 6000 127
EASYSEAL 152.4	152.4	6"	0368 6000 152
EASYSEAL 177.8	177.8	7"	0368 6000 178
EASYSEAL 203.2	203.2	8"	0368 6000 203

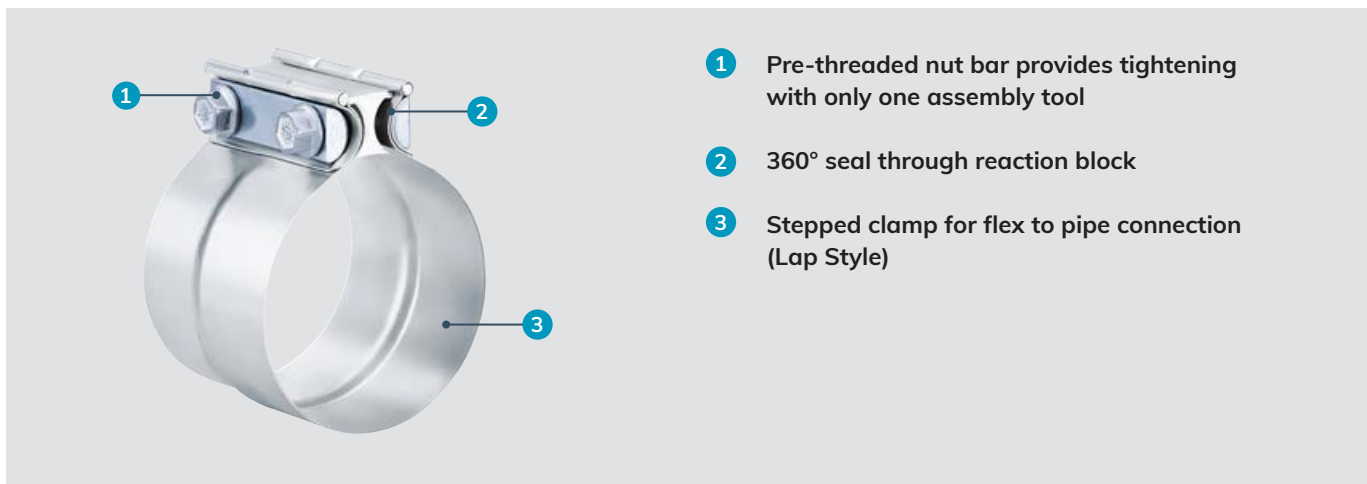

- 1 Pre-threaded nut bar provides tightening with only one assembly tool
- 2 360° seal through reaction block
- 3 Stepped clamp for flex to pipe connection (Lap Style)

Flexible wide band exhaust clamp

The NORMACONNECT® TorcTite stands out thanks to its durable clamping performance and superior clamp load capacities for pipes, flex and mufflers. It is available in two versions: with lap style joint for connecting pipes with different diameters or to connect flex to pipe. And with butt style joint to connect pipes with the same diameter.

Advantages at a glance

- ✓ Pre-threaded nut bar provides tightening with only one assembly tool
- ✓ Can be used to connect pipes with different diameters
- ✓ Compatible with pipes, flex and mufflers
- ✓ 360° seal through reaction block
- ✓ Durable installation without damage to pipe ends (puckering)

Applications

Flex to pipe and pipe to pipe connections in exhaust systems

Materials

- 304SS band
- Aluminum Reaction block
- Carbon steel zinc plated bolt

Technical data & Ordering information

NORMACONNECT® TORCTITE - Lap Style Joint			
Designation	Diameters		Product No.
	in mm	in inches	
TORCTITE LS 50.8	50.8	2"	0368 6112 051
TORCTITE LS 52.7	57.2	2 1/4"	0368 6103 057
TORCTITE LS 63.5	63.5	2 1/2"	0368 6111 064
TORCTITE LS 69.9	69.9	2 3/4"	0368 6105 070
TORCTITE LS 76.2	76.2	3"	0368 6110 076
TORCTITE LS 88.9	88.9	3 1/2"	0368 6113 089
TORCTITE LS 101.6	101.6	4"	0368 6125 102
TORCTITE LS 114.3	114.3	4 1/2"	0368 6110 114
TORCTITE LS 127	127	5"	0368 8125 127
TORCTITE LS 152.4	152.4	6"	0368 6120 152

NORMACONNECT® TORCTITE - Butt Style Joint			
Designation	Diameters		Product No.
	in mm	in inches	
TORCTITE BS 50.8	50.8	2"	0368 0300 051
TORCTITE BS 52.7	57.2	2 1/4"	0368 0300 057
TORCTITE BS 63.5	63.5	2 1/2"	0368 0302 064
TORCTITE BS 69.9	69.9	2 3/4"	0368 0302 070
TORCTITE BS 76.2	76.2	3"	0368 0301 076
TORCTITE BS 88.9	88.9	3 1/2"	0368 0302 089
TORCTITE BS 101.6	101.6	4"	0368 0303 102
TORCTITE BS 114.3	114.3	4 1/2"	0368 0304 114
TORCTITE BS 127	127	5"	0368 0304 127
TORCTITE BS 152.4	152.4	6"	0368 0304 152

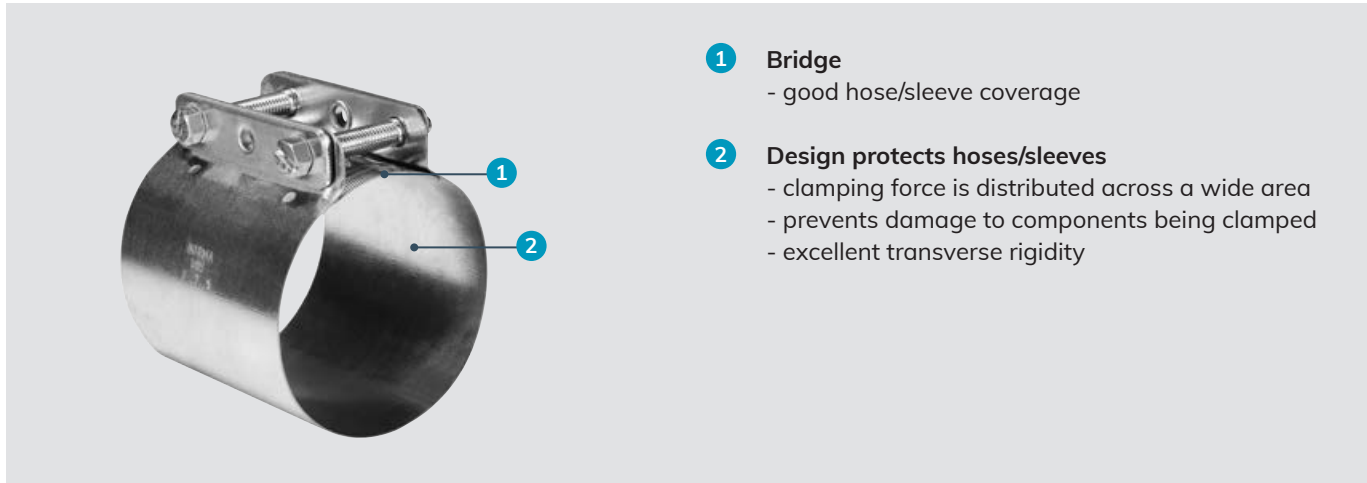

- 1 Bridge**
- good hose/sleeve coverage
- 2 Design protects hoses/sleeves**
- clamping force is distributed across a wide area
- prevents damage to components being clamped
- excellent transverse rigidity

Wide-band hose clamps in accordance with DIN 3017-5

Used in conjunction with a rubber sleeve, NORMACONNECT® BRS wide-band hose clamps are the ideal choice for connecting pipes with smooth ends. They connect cast iron and steel pipes just as securely as plastic or glass pipes and without any welding.

NORMACONNECT® wide-band hose and retaining clamps are produced with standardized band widths and materials. The progressive ratio is 1 mm in the case of a single-part version. Up to a clamping diameter of 300 mm, the clamps are supplied in rolled-up form. With clamping diameters of 301 mm and upwards, they are supplied in stretched-out form.

Advantages at a glance

- ✓ Extremely wide band
- ✓ Clamping force distributed over a large area
- ✓ High level of transverse rigidity
- ✓ Single-part and multi-part versions

Applications

- Machine building
- White goods
- Food and beverage industry
- Agricultural machines
- Engine manufacturing
- Exhaust air technology
- Suction systems
- Laboratory technology
- Drainage technology

Materials

W1	W2	W3	W4	W5
	x		x	

Material	Corrosion resistance in salt spray testing
W2	Min. 72 h
W4	Min. 240 h

Bolts

NORMACONNECT® BRS			
Band width	Sz in the case of W2		Sk in the case of W4
48	M6 x 38 Sz		M6 x 45 Sk
54	M8 x 47 Sz		M8 x 50 Sk
65	M8 x 47 Sz		M8 x 50 Sk

Technical data

NORMACONNECT® BRS				
Band width in mm	Minimum diameter in mm	Static tightening torque in Nm	Material thickness in mm	
			W2	W4
48	50	4	0.4	0.5
54	50	12	0.4	0.5
65	50	12	0.4	0.5

Ordering information

	1. Type	2. Clamping range	3. Band width	4. Material	5. Bolt
Example	BRS	55	48	W2	Sz



- 1** Cover band
- optimum distribution of clamping forces
- 2** Closure
- 3** 3 profile segments
- ease of assembly



The STC-type closure is a cost effective alternative to conventional T-bolt closures.

Profile clamp with cover band

The NORMACONNECT® V Profile Clamps are reliable and time-effective connection elements for industrial and automotive use. They are made to customer requirements and can be supplied with various profiles, band widths and closure types.

Advantages at a glance

- ✓ Low friction losses
- ✓ Robust precision components
- ✓ High corrosion resistance
- ✓ State-of-the-art automated manufacturing
- ✓ Highly competitively priced

Materials

Code	Closures		Closure components	Profile segments/ Cover band
	STC	QRC		
W4	•	•	Stainless steel	Stainless steel

ISO	DIN	AISI	BS	AFNOR
X5 CrNi 18-10	1.4301	304	304 S 15	Z6 CN 18-09

Applications

- Automotive: Turbocharger – catalytic converter connection
- Automotive: Diesel particulate filter
- Industry: Bulk material container
- Industry: Bypass filter unit

Product's method of operation

The profile clamp's method of operation is based on the principle of an inclined plane. When the closure bolt is tightened, this exerts circumferential force on the profile segments. The two halves of the flange are pressed together by means of the profile (see diagram below). The circumferential force that is exerted is converted into considerably higher axial force.

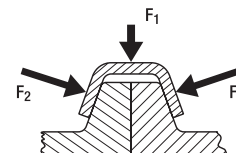

All profiles at a glance

- Single-part 3 profile segments
- Available up to diameter 300 mm
- Two-part 2 profile segments
- Available from diameter 200 mm up to 500 mm

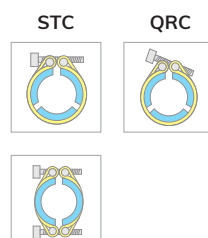

Example of flange designs

Use of gasket may be required in some applications. Support and advice on gasket selection can be provided.

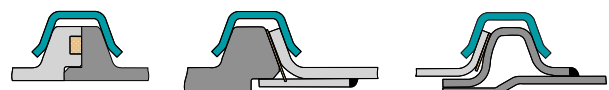

Profile types

NORMA CONNECT®

4.0 b		≥ ø 89		5.0 a		≥ ø 82		5.3 b		≥ ø 108		6.0 a		≥ ø 82	
	20 mm	25 mm		20 mm	25 mm		20 mm	25 mm		20 mm	25 mm		20 mm	25 mm	
STC	•		STC	•		STC	•		STC	•		STC	•		
QRC	•		QRC	•		QRC	•		QRC	•		QRC	•		
6.6 b		≥ ø 90		9.2 a		≥ ø 100		10.2 a		≥ ø 98		14.5 a		≥ ø 100	
	20 mm	25 mm		20 mm	25 mm		20 mm	25 mm		20 mm	25 mm		20 mm	25 mm	
STC	•		STC		•	STC		•	STC		•	STC		•	
QRC	•		QRC		•	QRC		•	QRC		•	QRC		•	

The inner profile diameter can be freely selected in millimeter increments. All profiles can be supplied with a diameter of up to ø 500 mm. Please refer to the relevant profile diagram in the table below to find out the minimum diameter permissible for that profile.

Profile clamps can be supplied with cover bands measuring 20 mm or 25 mm in width.

The table above indicates which cover band is suitable for which profile.

Examples of flange structures

Inner profile ø		Flange 1				Flange 2				Flange 3				Flange 4			
Profile type	Profile ø (mm)	W (mm)	H (mm)	W (mm)	H (mm)	R (mm)	T (mm)	W (mm)	H (mm)	R (mm)	T (mm)	W (mm)	H (mm)	R (mm)	T (mm)		
4.0b	≥ 89	5.1	7.5	5.1	8	2	2	5.1	7.5	1	1	Not recommended					
5.0a	≥ 82	6.1	4.6	6.1	4.6	1.5	1.5	6.1	4.6	1	1	6.1	4.6	1.5	1.5		
5.3b	≥ 108	6.4	7.3	6.4	7.8	2	2	6.4	7.3	1.5	1.5	6.4	7.8	2	2		
6.0a	≥ 82	7.1	4	7.1	4	1.5	1.5	Not recommended				7.1	4	1.5	1.5		
6.6b	≥ 90	7.7	6.6	7.7	6.6	1.5	1.5	7.7	6.6	1.5	1.5	7.7	6.6	1.5	1.5		
9.2a	≥ 100	10.3	7.3	10.3	7.8	2	2	10.3	7.8	2	2	10.3	7.8	2	2		
10.2a	≥ 98	11.3	7.3	11.3	7.8	2	2	11.3	7.8	2	2	11.3	7.8	2	2		
14.5a	≥ 100	15.6	7.4	15.6	7.9	2	2	15.6	7.9	2	2	Not recommended					
Abbreviations: W = overall flange width H = overall flange height R = flange radius T = flange thickness																	

Technical information

Profile type	Profile ϕ (mm)	Performance (stainless steel only)
5.0a 6.0a 6.6b	≥ 82 ≥ 82 ≥ 90	<p>Profile 1mm</p>
4.0b 7.9b 14.5a	≥ 89 ≥ 108 ≥ 100	<p>Profile 1.5mm</p>
10.2a 11.4b	≥ 98 ≥ 180	<p>Profile 2.0mm</p>

1. Determine the **application or test pressure**.
2. Determine the **max. operating temperature** to which the profile clamp will be exposed.
(Note: The profile clamps presented in this catalogue have been designed for a maximum operating temperature of 400 °C.)
3. Calculate the required inner diameter of the profile as follows:
outer flange diameter + 3 mm
4. Using the diagrams on the left. Check whether the profile thickness you have selected will be sufficient.
(Note: The result only represents an initial approximation based on static pressures and ideal operating conditions.)

Other factors may come into play, such as:

- Shape of and material used for sealing measures
- Roughness of flange surface
- Operating temperatures
- Bending moments
- Pressure surges/Vibrations
- Safety requirements

Based on these factors, you may decide that a thicker profile is necessary.

5. The tables below provide information on the tightening torques for the various closure types and bolt sizes.
- 5.1. Recommended tightening torque for STC & QRC-type closures:

Band with	Bolt	Tightening torque
20 mm	M 6	6 Nm +/-1
25 mm	M 8	12 Nm +/-1

Example of application:

- Operating pressure: 4 bar (static)
- Temperature: 20 °C
- Profile type: 4.0b
- Profile thickness: 1.5 mm
- Flange diameter: ϕ 197 mm
- Inner profile diameter: ϕ 200 mm

Max. permissible pressure at 20 °C:

- 5.4 bar > 4 bar <OK

Application areas

NORMACONNECT® V profile clamps are quick-release connecting elements for flanges and represent an economical alternative to conventional bolted flange connections.



Automotive:
Turbocharger – catalytic
converter connection

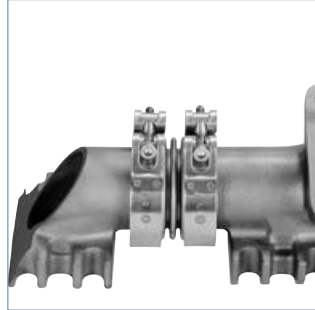

Automotive:
Exhaust manifold



Industry:
Bulk material container



Industry:
Bypass filter unit



The NORMACONNECT® V QRC come with a unique quick release closure for rapid assembly. The V QRC clamps are used in different segments of exhaust systems as well as turbocharger installations and offer excellent corrosion resistance properties.

Advantages at a glance

- Rapid closing and opening
- Captive closure components
- Significantly shorter installation
- Closure bolt secured during tightening

Material

W4

NORMACONNECT® V QRC								
Designation	Ø DN (mm)	Profile dimensions						W4 Part No.
		w1 (mm)	w2 (mm)	h1 (mm)	h2 (mm)	Ø1 (mm)	Ø2 (mm)	
V-QRC 077	77	6.6	-	4.7	-	40°	-	0633 0580 077
V-QRC 077	77	8.2	17	4.0	-	40°	-	0633 0578 077
V-QRC 080	80	4.5	13.6	5.8	7.5	40°	70°	0633 0579 080
V-QRC 080	80	8.7	-	5.8	7.6	40°	90°	0633 0577 080
V-QRC 082	82	4.3	13.6	4.0	7.0	40°	-	0633 2633 082
V-QRC 085	85	9	-	7.0	-	40°	-	0633 0576 085
V-QRC 097	97	7.9	-	5.2	-	40°	-	0633 0575 097
V-QRC 098	98	8.8	-	5.4	7.5	40°	90°	0633 3633 098
V-QRC 103	103	6.5	-	3.6	5.05	40°	90°	0633 0574 103
V-QRC 108	108	13.6	-	4.0	7.0	40°	-	0633 2633 108
V-QRC 112	112	6.5	-	7.8	-	40°	-	0633 4633 112
V-QRC 115	115	7.9	-	5.4	7.8	40°	90°	0633 2633 115
V-QRC 124	124	6.5	-	4.6	-	40°	-	0633 0571 124
V-QRC 131	131	6.5	20	7.2	-	40°	-	0633 4633 131
V-QRC 135	135	6.5	-	7.8	-	40°	-	0633 4633 135
V-QRC 143	143	7.9	-	5.8	7.5	40°	90°	0633 1633 143
V-QRC 145	145	6.5	-	7.8	-	40°	-	0633 4633 145
V-QRC 155	146	6.5	20	7.2	-	40°	-	0633 4633 146
V-QRC 152	152	9.2	-	6.8	-	40°	-	0633 0572 152
V-QRC 152	152	7.9	-	5.8	7.0	40°	90°	0633 1633 152
V-QRC 155	155	6.5	-	7.8	-	40°	-	0633 4633 155
V-QRC 179	179	7.9	-	5.3	7.5	40°	90°	0633 2633 179
V-QRC 185	185	7.9	-	5.8	7.5	40°	90°	0633 1633 185
V-QRC 317	317	7.9	-	5.8	7.5	40°	90°	0632 4632 317
NORMACONNECT® V STC								
V-STC 219	219	7.9	-	5.8	7.5	40°	90°	0632 2632 219
V-STC 404	404	6.5	-	7.8	-	40°	-	0632 4632 404

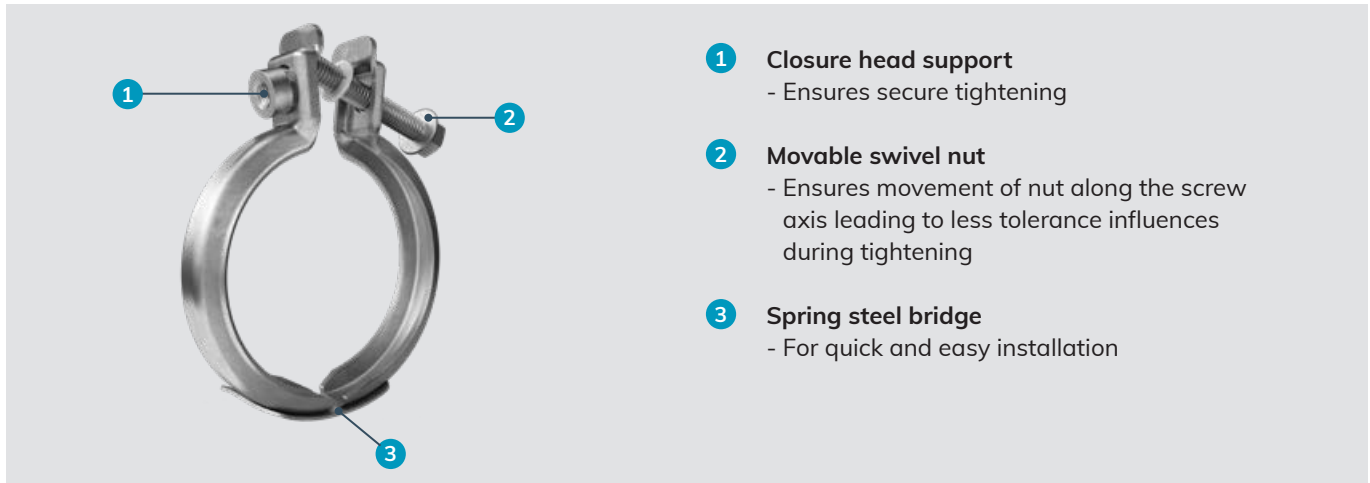

- 1 Closure head support**
- Ensures secure tightening
- 2 Movable swivel nut**
- Ensures movement of nut along the screw axis leading to less tolerance influences during tightening
- 3 Spring steel bridge**
- For quick and easy installation

High performance profile clamp

NORMACONNECT® VPP Bridge is a high performance clamp designed to withstand extreme temperatures upto 1050 °C. It is designed for easy and quick installation and high clamping forces.

Advantages at a glance

- ✔ Operates at higher temperatures than conventional profile clamps
- ✔ Quick and easy installation due to spring bridge
- ✔ Higher clamping force than conventional clamps
- ✔ Minimum installation space required

Applications

The VPP bridge clamps offer a connection solution to applications exposed to high temperatures. It is used in different segments of exhaust systems as well as turbocharger installations. A typical application are petrol turbocharger connections.

Materials

W1	W2	W3	W4	W5
				x

Technical drawing

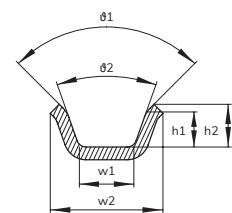

Technical data & Ordering information

NORMACONNECT® VPP BRIDGE								
Designation	Ø DN (mm)	Profile dimensions						W5 Part No.
		w1 (mm)	w2 (mm)	h1 (mm)	h2 (mm)	Ø1 (mm)	Ø2 (mm)	
VPP Bridge 079	79	8.55	17.15	5.5	6.7	39°	90°	0168 0000 079
VPP Bridge 083	83	8.55	17.15	5.5	6.7	39°	90°	0168 0000 083
VPP Bridge 086	86	8.55	17.15	5.5	6.7	39°	90°	0168 0000 086
VPP Bridge 094	94	8.55	17.15	5.5	6.7	39°	90°	0168 0000 094
VPP Bridge 096	96	8.55	17.15	5.5	6.7	39°	90°	0168 0000 096
VPP Bridge 098	98	8.55	17.15	-	6.0	40°	-	0168 0000 098
VPP Bridge 101	101	8.55	17.15	5.8	7.2	39°	90°	0168 0000 101
VPP Bridge 107	107	8.55	17.15	5.5	6.7	39°	90°	0168 0000 107
VPP Bridge 113	113	8.55	17.15	5.5	6.7	39°	90°	0168 0000 113
VPP Bridge 120	120	8.55	17.15	5.5	6.7	39°	90°	0168 0000 120
VPP Bridge 138	138	8.55	17.15	5.3	6.7	39°	90°	0168 0000 138

NORMAFIX® – Retaining Products

Versatile products for a whole host of applications

The NORMAFIX® range of clamps, clips and systems for retaining pipes, cables, cable harnesses and hoses are ready for action wherever they're needed – walls, ceilings or car bodies.





Smooth round edges

- easier to handle and safer to install

Variety of colors

- available in: black, white, red, yellow, green, blue

“Carbon Black” added in black cable tie flange

- increased resistance to UV rays
- suitable for outdoor use

Quick and safe securing of cables in material PA 6.6

NORMAFIX® Cable Tie for securing cables in electrical installations, industrial wiring, automotive, etc. Made of polyamide 6.6. Resistant to extreme temperatures and numerous external agents. Quick and safe assembly. The black cable tie offers excellent resistance to UV rays thanks to added “carbon black.”



NORMAFIX®

Advantages at a glance

- ✓ Made of polyamide 6.6 for optimum resistance to extreme temperatures, bases, oils, greases, etc.
- ✓ Bent rounded tip allows easier insertion through the head of the cable ties
- ✓ Low-friction material coefficient allows a faster installation

Applications

- Electrical installations
- Industrial cabling
- Automotive cabling
- Marine cabling
- Panel building
- Special applications

Materials

Polyamide 6.6: Characteristics of raw material

Working temperature:	-45 °C to 85 °C
Tightening temperature:	-10 °C to 60 °C
Max admissible point:	120 °C*
Melting temperature:	256 °C
Limiting Oxygen Index (LOI):	27 %
Recovery of moisture:	2.7 % to 50 % relative humidity

Halogen free: Evaluated according to EN 50146.

Flame retardancy according to UL 94-V2

Resistance to external agents

- Excellent resistance to aromatic solvents, bases, oils, fat, petroleum products
- Maintain limited contact with acid
- Not resistant to phenol and chlorinated solvents
- Resistance to UV (black colored cable ties)**

Information

EC directives

The material used to produce our cable ties complies with the following EC directives:

- 2000/53/EC (VHU)
- 2002/65/UE (RoHS)
- 2002/96/EC (DEEE)
- 2006/95/EC

* (for a short time)

** The black cable ties are loaded with carbon black. Therefore they possess UV resistance according to standard ISO QUV-B 4892 (150 hours), equivalent to 3 years of exposure to sunlight. They are also particularly recommended for external applications.

Technical data & Ordering information

NORMAFIX® CABLE TIES										
Width	Designation	Length in mm	Maximum diameter in mm	Resistance to traction in kgs	White Product No.	Black Product No.	Red Product No.	Yellow Product No.	Green Product No.	Blue Product No.
2.5	CABLE TIE 2.5 x 98	98	21	8	0860 0110 201	0860 0210 201	0860 0310 201	0860 0320 201	0860 0330 201	0860 0340 201
2.6	CABLE TIE 2.6 x 160	160	40	8	0860 0110 302	0860 0210 302				
3.5	CABLE TIE 3.5 x 140	140	35	13	0860 0110 401	0860 0210 401	0860 0310 401	0860 0320 401	0860 0330 401	0860 0340 401
	CABLE TIE 3.5 x 200	200	50	13	0860 0110 402	0860 0210 402	0860 0310 402	0860 0320 402	0860 0330 402	0860 0340 402
	CABLE TIE 3.5 x 290	290	80	13	0860 0110 403	0860 0210 403				
	CABLE TIE 3.5 x 370	370	103	13	0860 0110 404	0860 0210 404				
4.5	CABLE TIE 4.5 x 120	120	24	20	0860 0110 501	0860 0210 501				
	CABLE TIE 4.5 x 160	160	40	20	0860 0110 502	0860 0210 502				
	CABLE TIE 4.5 x 200	200	50	22	0860 0110 602	0860 0210 602	0860 0310 601	0860 0320 601	0860 0330 601	0860 0340 601
4.8	CABLE TIE 4.8 x 178	178	45	22	0860 0110 601	0860 0210 601				
	CABLE TIE 4.8 x 250	250	68	22	0860 0110 603	0860 0210 603				
4.5	CABLE TIE 4.5 x 290	290	79	22	0860 0110 604	0860 0210 604	0860 0310 602	0860 0320 602	0860 0330 602	0860 0340 602
	CABLE TIE 4.5 x 360	360	103	22	0860 0110 605	0860 0210 605				
4.8	CABLE TIE 4.8 x 390	390	106	22	0860 0110 606	0860 0210 606				
4.5	CABLE TIE 4.5 x 430	430	115	22	0860 0110 607	0860 0210 607				
7.8	CABLE TIE 7.8 x 180	180	45	55	0860 0110 702	0860 0210 702				
	CABLE TIE 7.8 x 240	240	63	55	0860 0110 703	0860 0210 703				
	CABLE TIE 7.8 x 300	300	80	55	0860 0110 704	0860 0210 704				
7.5	CABLE TIE 7.5 x 365	365	100	55	0860 0110 705	0860 0210 705				
	CABLE TIE 7.5 x 450	450	130	55	0860 0110 706	0860 0210 706				
	CABLE TIE 7.5 x 540	540	158	55	0860 0110 707	0860 0210 707				
	CABLE TIE 7.5 x 750	750	200	55	0860 0110 708	0860 0210 708				
9	CABLE TIE 9 x 780	780	233	77	0860 0110 801	0860 0210 801				
12.5	CABLE TIE 12.5 x 500	500	143	110	0860 0110 902	0860 0210 902				
	CABLE TIE 12.5 x 1000	1000	302	110	0860 0110 905	0860 0210 905				



Refer to pages 192 and 197

CABLE TIE WITH METAL BARB

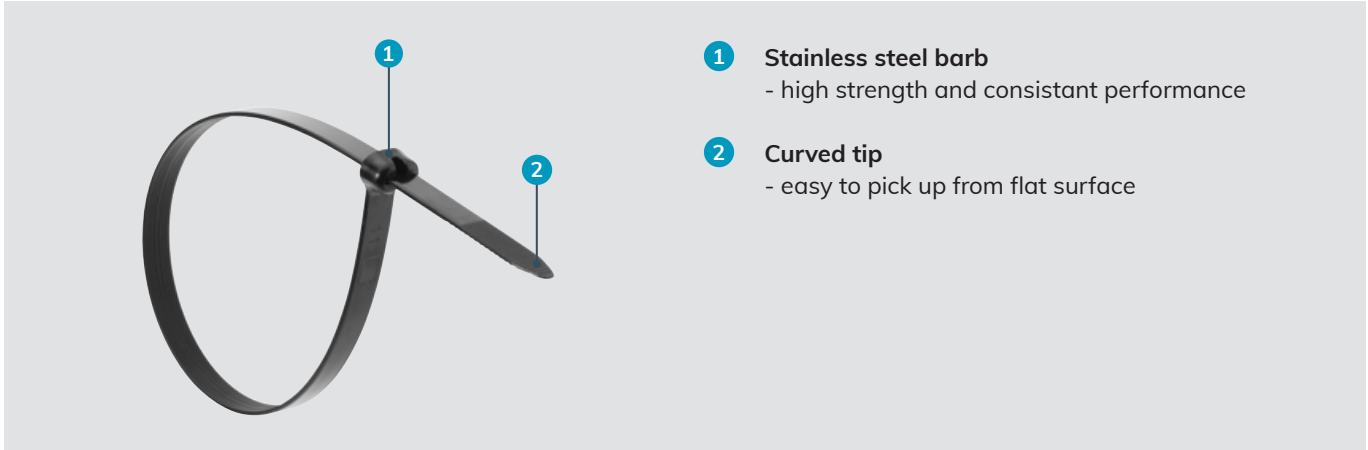

- 1 Stainless steel barb**
- high strength and consistent performance
- 2 Curved tip**
- easy to pick up from flat surface

Cable tie for high strength fixing

Made of Nylon 66 and 304 barb; this cable tie is a better choice for high strength applications.

Advantages at a glance

- ✓ Stainless steel barb provides consistent performance and reliability and infinite adjustability through entire bundle range
- ✓ High strength and low thread force
- ✓ Stippled strap body prevents lateral movement on the bundle
- ✓ Curved tip is easy to pick up from flat surface and allows faster initial threading to speed installation

Applications

- Electrical installations
- Industrial cabling
- Automotive cabling
- Marine cabling
- Panel building
- Special applications

Materials

Band: Nylon 66
Locking barb: SS 304 (W4)

Information

Our cable ties comply with the following directives:

- ABS (Product Approval)
- CE (Certificate of conformity)
- UL62275 (Cable management systems)
- Lloyd's Register
- DNV
- DNV GL
- RoHS

Characteristics

Material-Locking Barb: Stainless Steel 304
Working Temp: -40 °C to +85 °C
Color: Black and White
Flammability: UL94V-2
Other Properties: Halogen Free, UV-resistant (black cable ties)

Technical data & Ordering information

NORMAFIX® CABLE TIE WITH METAL BARB			
Width in mm	Designation	Length in mm	Black Product No.
2.4	CABLE TIE WITH METAL BARB 2.4 X 102	102	0892 7118 001
	CABLE TIE WITH METAL BARB 2.4 X 201	201	0892 7118 003
3.6	CABLE TIE WITH METAL BARB 3.6 X 155	155	0892 7118 006
	CABLE TIE WITH METAL BARB 3.6 X 200	200	0892 7118 009
	CABLE TIE WITH METAL BARB 3.6 X 284	284	0892 7118 007
4.8	CABLE TIE WITH METAL BARB 4.8 X 186	186	0892 7118 011
	CABLE TIE WITH METAL BARB 4.8 X 250	250	0892 7118 010
	CABLE TIE WITH METAL BARB 4.8 X 295	295	0892 7118 012
	CABLE TIE WITH METAL BARB 4.8 X 361	361	0892 7118 013
7.0	CABLE TIE WITH METAL BARB 7.0 X 221	221	0892 7118 016
	CABLE TIE WITH METAL BARB 7.0 X 378	378	0892 7118 018
	CABLE TIE WITH METAL BARB 7.0 X 699	699	0892 7118 021



Refer to pages 192 and 197

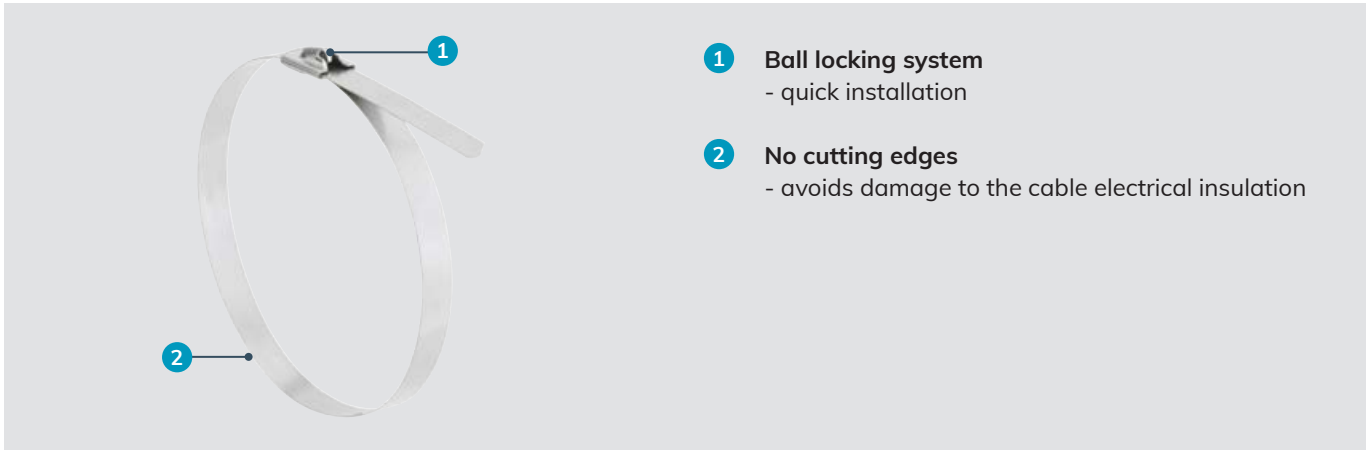

- 1 Ball locking system**
- quick installation
- 2 No cutting edges**
- avoids damage to the cable electrical insulation

Cable tie for high strength fixing

Made of stainless steel AISI 304 or AISI 316 with ball locking system, that enables quick installation and low insertion effort. This kind of cable tie is characterized by a high resistance to high temperature, to flame and corrosion.

Advantages at a glance

- ✓ Ball-lock type self-lock system, speeds installation
- ✓ Made entirely of high grade stainless steel, excellent corrosion and UV resistance.

Materials

Band: Stainless steel AISI 304 or 316

Technical data & Ordering information

Information

Our cable ties comply with the following directives:

- ABS (Product Approval)
- CE (Certificate of conformity)
- UL62275 (Cable management systems)
- Lloyd's Register
- DNV
- DNV GL
- RoHS

Characteristics

Made entirely of Stainless Steel
 Working Temp: -80 °C to +300 °C
 Flammability: Fireproof
 Other Properties: UV-resistant

Applications

- Cable and pipe fixing in shipbuilding, offshore, petrochemical plants, oil rigs, and environments with a risk of fire.
- Used as flame safety in electrical installations to fix the metal I.D. plates, which must be preserved in the event fire.
- Installations where high mechanical and UV resistance are required (photovoltaic).

NORMAFIX® STAINLESS STEEL BALL LOCKING CABLE TIE				
Width in mm	Designation	Length in mm	W4 Product No.	W5 Product No.
4.6	STAINLESS STEEL BALL LOCKING CABLE TIE 4.6x200	200	0892 7012 002	0892 7012 047
	STAINLESS STEEL BALL LOCKING CABLE TIE 4.6x250	250	0892 7012 003	0892 7012 048
	STAINLESS STEEL BALL LOCKING CABLE TIE 4.6x350	350	0892 7012 005	0892 7012 049
	STAINLESS STEEL BALL LOCKING CABLE TIE 4.6x450	450	0892 7012 007	0892 7012 050
	STAINLESS STEEL BALL LOCKING CABLE TIE 4.6x650	650	0892 7012 042	0892 7012 051
	STAINLESS STEEL BALL LOCKING CABLE TIE 4.6x800	800	0892 7012 043	0892 7012 052
	7.8	STAINLESS STEEL BALL LOCKING CABLE TIE 7.6x200	200	0892 7012 010
STAINLESS STEEL BALL LOCKING CABLE TIE 7.6x250		250	0892 7012 011	0892 7012 054
STAINLESS STEEL BALL LOCKING CABLE TIE 7.6x350		350	0892 7012 013	0892 7012 055
STAINLESS STEEL BALL LOCKING CABLE TIE 7.6x500		500	0892 7012 016	0892 7012 056
STAINLESS STEEL BALL LOCKING CABLE TIE 7.6x650		650	0892 7012 044	0892 7012 057
STAINLESS STEEL BALL LOCKING CABLE TIE 7.6x800		800	0892 7012 045	0892 7012 058
STAINLESS STEEL BALL LOCKING CABLE TIE 7.6x1000		1000	0892 7012 046	0892 7012 059



Refer to page 192

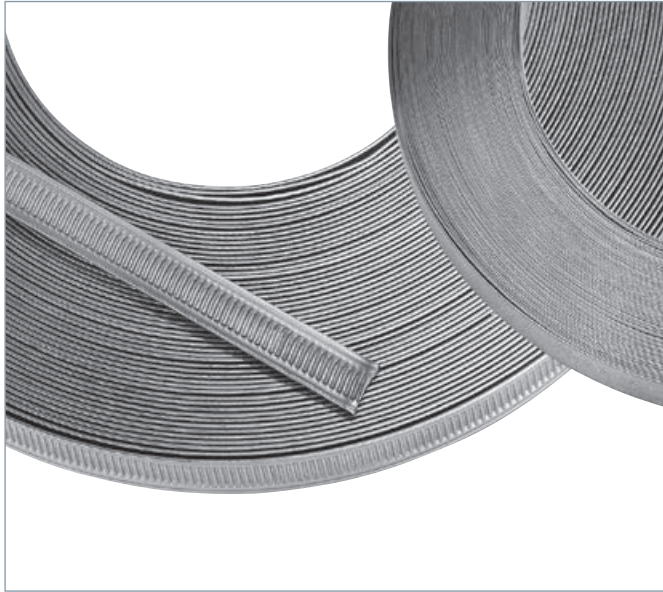

Continuous band available in smooth version or with thread stamping throughout

4 different closure types to suit a huge variety of applications



Continuous band clamping system

Consisting of a continuous band, the NORMAFIX® NORMETTA® system is able to adapt itself to the shape and size of various objects. 4 different types of closure are available to choose from. The system is particularly suitable for carrying out retaining and repair work under difficult and extreme conditions.

Advantages at a glance

- ✓ Flexible and versatile
- ✓ Can be installed under difficult conditions

Materials

W1	W2	W3	W4	W5
	x	x	x	

Applications

- Irrigation systems
- Railway industry
- Building machines
- Pump and filter
- Retaining applications; sealing pipes during repair work
- Attaching signs and containers
- Binding hoses

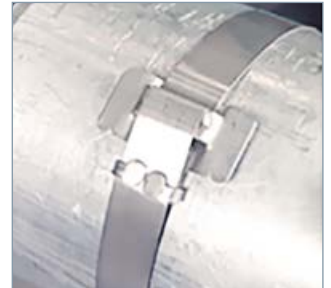

Product and closure types

The continuous band is available in three different versions: smooth band, stamped band or perforated band. Depending on the version, you will have a different choice of band widths, material grades and closure types.

Smooth band



To be used with the buckles, NB-D W4 and NB-H W4.

NORMAFIX® NORMETTA® SMOOTH BAND					
Width in mm	Thickness in mm	Designation	Length in m	W4 Product No.	
9	0.5	NORMETTA SMOOTH BAND 30M/9 W4	30	0560 8554 009	
13	0.7	NORMETTA SMOOTH BAND 30M/13 W4	30	0560 8553 013	
16	0.7	NORMETTA SMOOTH BAND 30M/16 W4	30	0560 8553 016	
19	0.7	NORMETTA SMOOTH BAND 30M/19 W4	30	0560 8553 019	

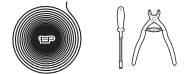

Refer to pages 186 and 192

Stamped band



To be used with the buckles NB-G W3.

NORMAFIX® NORMETTA® STAMPED BAND					
Width in mm	Thickness in mm	Designation	Length in m	Resistance to traction in N	W3 Product No.
12	0.8	NORMETTA STAMPED BAND 30M/12 W3	30	2600 N	0560 8566 003



Refer to page 192

Perforated Band



To be used with buckles NB-K W2.

NORMAFIX® NORMETTA® PERFORATED BAND						
Width in mm	Thickness in mm	Designation	Length in m	Resistance to traction in N	W2 Product No.	W4 Product No.
8	0.6	NORMETTA PERFORATED BAND 25M/8 W2	25	790 N	0817 7020 001	
	0.6	NORMETTA PERFORATED BAND 25M/8 W4	25	790 N		0817 7022 001
13	0.6	NORMETTA PERFORATED BAND 25M/13 W4	25	850 N		0817 7022 002
14	0.6	NORMETTA PERFORATED BAND 25M/14 W2	25	850 N	0817 7020 002	



Refer to page 192

NB-D



Closure type NB-D

Suitable for attaching signs and containers to pipes and hoses as well as binding hoses.
For bands: 9, 13, 16, 19 mm

Required tools: Clamping and cutting tool; hammer

NORMAFIX® NB-D		
For band width in mm	Designation	W4 Product No.
9	NB-D/9	0560 8550 009
13	NB-D/13	0560 8550 013
16	NB-D/16	0560 8550 016
19	NB-D/19	0560 8550 019



Refer to page 192

NB-G



Closure type NB-G

Suitable for applications with cramped installation conditions.
Can be re-used.

For stamped bands.

Required tools: Screwdriver or SW7 socket wrench and plate shears

NORMAFIX® NB-G		
For band width in mm	Designation	W3 Product No.
12	NB-G/12	0560 8565 003

NB-H



Closure type NB-H

An adjustable quick-release closure that enables fast and easy installation and removal. Can be re-used.

For bands: 16, 19 mm

Required tools: Screwdriver and plate shears

NORMAFIX® NB-H			
For band width in mm	Maximum diameter in mm	Designation	W1 Product No.
16 / 19	124	NB-H/124	0560 8558 124
	400	NB-H/400	0560 8558 400
	800	NB-H/800	0560 8558 800

NB-K



Closure type NB-K

Suitable for fixing suspended ventilation tubes.

For bands: 8, 13, 14 mm

Required tools: Screwdriver

NORMAFIX® NB-K			
For band width in mm	Designation	W2 Product No.	W4 Product No.
8	NB-K/8	0817 7019 003	0817 7021 003
13	NB-K/13		0817 7021 004
14	NB-K/14	0817 7019 004	



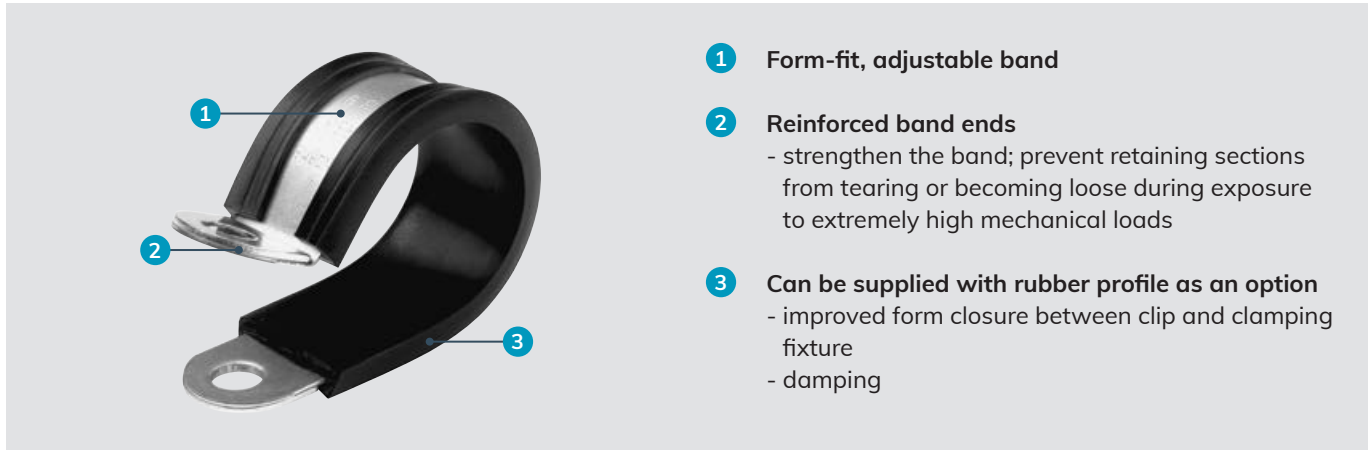

- 1 **Form-fit, adjustable band**
- 2 **Reinforced band ends**
 - strengthen the band; prevent retaining sections from tearing or becoming loose during exposure to extremely high mechanical loads
- 3 **Can be supplied with rubber profile as an option**
 - improved form closure between clip and clamping fixture
 - damping

Pipe retaining clips in accordance with DIN 3016

NORMAFIX® RS/RSGU pipe retaining clips are suitable for all kinds of fastening and retaining applications: pipes, cables, cable harnesses, cable protection pipes, hoses and other lines.

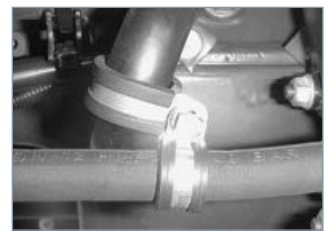

Advantages at a glance

- ✓ Easy installation and secure fastening
- ✓ Reinforced band ends for extremely high mechanical loads
- ✓ Rubber profile protects against vibrations and creeping water, is sound-absorbent and protects against contact corrosion

Applications

- Machine building
- White goods
- Chemical industry
- Irrigation systems
- Ship manufacturing
- Food and beverage industry
- Railway industry
- Agricultural machines
- Building machines
- Engine manufacturing
- Pump and filter
- Mining industry

Materials

W1	W2	W3	W4	W5
x		x*	x*	x

*W3 and W4 on request

Bolts

The scope of delivery does not include bolts or nuts.
 We recommend:
 For NORMAFIX® RSGU with 12 mm band width: M5 bolt
 For NORMAFIX® RSGU with 15 mm band width: M6 bolt
 For NORMAFIX® RSGU with 20 mm band width: M8 bolt

Rubber profile

Material properties of EPDM rubber profile		
Tensile strength [N/mm ²]		Min. 8
Elongation at break [%]		350
Shore hardness A		70 ± 5
Temperature [°C]		-40 to +120
Resistance to:	Weather/Ozone	Very good
	Aging/UV	Very good
	Fuel storage	Not suitable
	Storage in oils and greases	Not suitable
	Alcohols	Good
	Acids	Good
	Alkalis	Good

Silicone rubber profile also available on request.

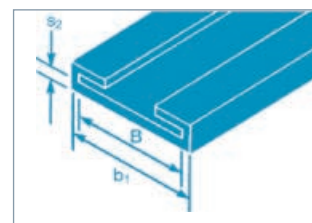

B = band width of clip

b₁ = width in mm

s₂ = material thickness in mm

Technical data & Ordering information

NORMAFIX® RSGU 1								
Band width in mm	Designation	Clamping ranges		h1 ~ in mm	b1 in mm	s2 in mm	W1 Product No.	W5 Product No.
		in mm	in inches					
12	RSGU1. 6/12	6	1/4"	8.0+	15.0	1.2	0941 8912 006	0941 7712 006
	RSGU1. 8/12	8	5/16"	8.0+	15.0	1.2	0941 8912 008	0941 7712 008
	RSGU1. 10/12	10	3/8"	8.0+	15.0	1.2	0941 8912 010	0941 7712 010
	RSGU1. 12/12	12	1/2"	8.0+	15.0	1.2	0941 8912 012	0941 7712 012
	RSGU1. 13/12	13	1/2"	8.0+	15.0	1.2	0941 8912 013	0941 7712 013
	RSGU1. 14/12	14	9/16"	8.0+	15.0	1.2	0941 8912 014	0941 7712 014
	RSGU1. 15/12	15	5/8"	8.0+	15.0	1.2	0941 8912 015	0941 7712 015
	RSGU1. 16/12	16	5/8"	8.0+	15.0	1.2	0941 8912 016	0941 7712 016
	RSGU1. 18/12	18	3/4"	8.0+	15.0	1.2	0941 8912 018	0941 7712 018
	RSGU1. 19/12	19	3/4"	8.0+	15.0	1.2	0941 8912 019	0941 7712 019
	RSGU1. 20/12	20	13/16"	8.0+	15.0	1.2	0941 8912 020	0941 7712 020
	RSGU1. 21/12	21	13/16"	8.0+	15.0	1.2	0941 8912 021	0941 7712 021
RSGU1. 22/12	22	7/8"	8.0+	15.0	1.2	0941 8912 022	0941 7712 022	
15	RSGU1. 6/15	6	1/4"	11.2+	18.5	1.5	0941 8915 006	0941 7715 006
	RSGU1. 8/15	8	5/16"	11.2+	18.5	1.5	0941 8915 008	0941 7715 008
	RSGU1. 10/15	10	3/8"	11.2+	18.5	1.5	0941 8915 010	0941 7715 010
	RSGU1. 12/15	12	1/2"	11.2+	18.5	1.5	0941 8915 012	0941 7715 012
	RSGU1. 13/15	13	1/2"	11.2+	18.5	1.5	0941 8915 013	0941 7715 013
	RSGU1. 14/15	14	9/16"	11.2+	18.5	1.5	0941 8915 014	0941 7715 014
	RSGU1. 15/15	15	5/8"	11.2+	18.5	1.5	0941 8915 015	0941 7715 015
	RSGU1. 16/15	16	5/8"	11.2+	18.5	1.5	0941 8915 016	0941 7715 016
	RSGU1. 18/15	18	3/4"	11.2+	18.5	1.5	0941 8915 018	0941 7715 018
	RSGU1. 19/15	19	3/4"	11.2+	18.5	1.5	0941 8915 019	0941 7715 019
	RSGU1. 20/15	20	13/16"	11.2+	18.5	1.5	0941 8915 020	0941 7715 020
	RSGU1. 21/15	21	13/16"	11.2+	18.5	1.5	0941 8915 021	0941 7715 021
	RSGU1. 22/15	22	7/8"	11.2+	18.5	1.5	0941 8915 022	0941 7715 022
	RSGU1. 23/15	23	7/8"	11.2+	18.5	1.5	0941 8915 023	0941 7715 023
	RSGU1. 25/15	25	1"	11.2+	18.5	1.5	0941 8915 025	0941 7715 025
	RSGU1. 26/15	26	11/16"	11.2+	18.5	1.5	0941 8915 026	0941 7715 026
	RSGU1. 28/15	28	11/8"	11.2+	18.5	1.5	0941 8915 028	0941 7715 028
	RSGU1. 30/15	30	13/16"	11.2+	18.5	1.5	0941 8915 030	0941 7715 030
RSGU1. 32/15	32	11/4"	11.2+	18.5	1.5	0941 8915 032	0941 7715 032	
RSGU1. 34/15	34	15/16"	11.2+	18.5	1.5	0941 8915 034	0941 7715 034	
RSGU1. 35/15	35	13/8"	11.2+	18.5	1.5	0941 8915 035	0941 7715 035	
20	RSGU1. 10/20	10	3/8"	14.5+	25.0	2.0	0941 8920 010	0941 7720 010
	RSGU1. 12/20	12	1/2"	14.5+	25.0	2.0	0941 8920 012	0941 7720 012
	RSGU1. 13/20	13	1/2"	14.5+	25.0	2.0	0941 8920 013	0941 7720 013
	RSGU1. 14/20	14	9/16"	14.5+	25.0	2.0	0941 8920 014	0941 7720 014
	RSGU1. 15/20	15	5/8"	14.5+	25.0	2.0	0941 8920 015	0941 7720 015
	RSGU1. 16/20	16	5/8"	14.5+	25.0	2.0	0941 8920 016	0941 7720 016
	RSGU1. 18/20	18	3/4"	14.5+	25.0	2.0	0941 8920 018	0941 7720 018
	RSGU1. 19/20	19	3/4"	14.5+	25.0	2.0	0941 8920 019	0941 7720 019
	RSGU1. 20/20	20	13/16"	14.5+	25.0	2.0	0941 8920 020	0941 7720 020
	RSGU1. 22/20	22	7/8"	14.5+	25.0	2.0	0941 8920 022	0941 7720 022
	RSGU1. 23/20	23	7/8"	14.5+	25.0	2.0	0941 8920 023	0941 7720 023
	RSGU1. 24/20	24	15/16"	14.5+	25.0	2.0	0941 8920 024	0941 7720 024
	RSGU1. 25/20	25	1"	14.5+	25.0	2.0	0941 8920 025	0941 7720 025
	RSGU1. 28/20	28	11/8"	14.5+	25.0	2.0	0941 8920 028	0941 7720 028
	RSGU1. 30/20	30	13/16"	14.5+	25.0	2.0	0941 8920 030	0941 7720 030
	RSGU1. 32/20	32	11/4"	14.5+	25.0	2.0	0941 8920 032	0941 7720 032
	RSGU1. 34/20	34	15/16"	14.5+	25.0	2.0	0941 8920 034	0941 7720 034
	RSGU1. 35/20	35	13/8"	14.5+	25.0	2.0	0941 8920 035	0941 7720 035
RSGU1. 36/20	36	17/16"	14.5+	25.0	2.0	0941 8920 036	0941 7720 036	
RSGU1. 38/20	38	11/2"	14.5+	25.0	2.0	0941 8920 038	0941 7720 038	
RSGU1. 40/20	40	19/16"	14.5+	25.0	2.0	0941 8920 040	0941 7720 040	

Band width 9 mm and 25 mm available as standard

Additional diameters available on request

Alternative rubber profiles (e.g. silicone) available on request

RSGU 0



NORMAFIX® RSGU 0					
Band width in mm	Min. Clamping range (mm)	Rubber Sleeve			
		Width (mm)	Thickness (mm)	EPDM	Silicone
9	4	12.5	1.0	•	–
12	4	15.0	1.2	•	•
15	5	18.5	1.5	•	•
20	10	25.0	2.0	•	•
25	15	31.0	3.0	•	•

Available on request



Refer to page 194

RSGU 2



NORMAFIX® RSGU 2					
Band width in mm	Min. Clamping range (mm)	Rubber Sleeve			
		Width (mm)	Thickness (mm)	EPDM	Silicone
9	4	12.5	1.0	•	–
12	4	15.0	1.2	•	•
15	5	18.5	1.5	•	•
20	10	25.0	2.0	•	•
25	15	31.0	3.0	•	•

Available on request



Refer to page 194

RSGUV 1



The NORMAFIX® RSGUV 1 can be pre-positioned on the hose. The locking device keeps the RSGUV 1 safely in place if it needs to be stocked or transported prior to its final assembly.

Available in band widths of 15 and 20 mm, in the same dimensions as our RSGU 1. This system can only be fixed by using a special tool.

Advantages at a glance

- Safe pre-assembly on the hose
- No unintentional opening of the clamp during handling or transportation

Materials

W1, W3, W4, W5



Refer to page 194

RS 1



NORMAFIX® RS 1									
Band width in mm	Designation	Clamping ranges		d in mm	h1 ~ in mm	l in mm	s in mm	W1 Product No.	W5 Product No.
		in mm	in inches						
12	RS 1. 6/12	6	1/4"	5.3 (M5)	6.8+	5.0	0.5	0411 8912 006	0411 7712 006
	RS 1. 8/12	8	5/16"	5.3 (M5)	6.8+	5.0	0.5	0411 8912 008	0411 7712 008
	RS 1. 10/12	10	3/8"	5.3 (M5)	6.8+	5.0	0.5	0411 8912 010	0411 7712 010
	RS 1. 12/12	12	1/2"	5.3 (M5)	6.8+	5.0	0.5	0411 8912 012	0411 7712 012
	RS 1. 13/12	13	1/2"	5.3 (M5)	6.8+	5.0	0.5	0411 8912 013	0411 7712 013
	RS 1. 14/12	14	9/16"	5.3 (M5)	6.8+	5.0	0.5	0411 8912 014	0411 7712 014
	RS 1. 15/12	15	5/8"	5.3 (M5)	6.8+	5.0	0.5	0411 8912 015	0411 7712 015
	RS 1. 16/12	16	5/8"	5.3 (M5)	6.8+	5.0	0.5	0411 8912 016	0411 7712 016
	RS 1. 18/12	18	3/4"	5.3 (M5)	6.8+	5.0	0.5	0411 8912 018	0411 7712 018
	RS 1. 19/12	19	3/4"	5.3 (M5)	6.8+	5.0	0.5	0411 8912 019	0411 7712 019
	RS 1. 20/12	20	13/16"	5.3 (M5)	6.8+	5.0	0.5	0411 8912 020	0411 7712 020
	RS 1. 21/12	21	13/16"	5.3 (M5)	6.8+	5.0	0.5	0411 8912 021	0411 7712 021
RS 1. 22/12	22	7/8"	5.3 (M5)	6.8+	5.0	0.5	0411 8912 022	0411 7712 022	
15	RS 1. 6/15	6	1/4"	6.4 (M6)	9.7+	6.0	0.6	0411 8915 006	0411 7715 006
	RS 1. 8/15	8	5/16"	6.4 (M6)	9.7+	6.0	0.6	0411 8915 008	0411 7715 008
	RS 1. 10/15	10	3/8"	6.4 (M6)	9.7+	6.0	0.6	0411 8915 010	0411 7715 010
	RS 1. 12/15	12	1/2"	6.4 (M6)	9.7+	6.0	0.6	0411 8915 012	0411 7715 012
	RS 1. 13/15	13	1/2"	6.4 (M6)	9.7+	6.0	0.6	0411 8915 013	0411 7715 013
	RS 1. 14/15	14	9/16"	6.4 (M6)	9.7+	6.0	0.8	0411 8915 014	0411 7715 014
	RS 1. 15/15	15	5/8"	6.4 (M6)	9.7+	6.0	0.8	0411 8915 015	0411 7715 015
	RS 1. 16/15	16	5/8"	6.4 (M6)	9.7+	6.0	0.8	0411 8915 016	0411 7715 016
	RS 1. 18/15	18	3/4"	6.4 (M6)	9.7+	6.0	0.8	0411 8915 018	0411 7715 018
	RS 1. 19/15	19	3/4"	6.4 (M6)	9.7+	6.0	0.8	0411 8915 019	0411 7715 019
	RS 1. 20/15	20	13/16"	6.4 (M6)	9.7+	6.0	0.8	0411 8915 020	0411 7715 020
	RS 1. 21/15	21	13/16"	6.4 (M6)	9.7+	6.0	0.8	0411 8915 021	0411 7715 021
	RS 1. 22/15	22	7/8"	6.4 (M6)	9.7+	6.0	0.8	0411 8915 022	0411 7715 022
	RS 1. 23/15	23	7/8"	6.4 (M6)	9.7+	6.0	0.8	0411 8915 023	0411 7715 023
	RS 1. 25/15	25	1"	6.4 (M6)	9.7+	6.0	0.8	0411 8915 025	0411 7715 025
	RS 1. 26/15	26	11/16"	6.4 (M6)	9.7+	6.0	0.8	0411 8915 026	0411 7715 026
	RS 1. 28/15	28	11/8"	6.4 (M6)	9.7+	6.0	0.8	0411 8915 028	0411 7715 028
	RS 1. 30/15	30	13/16"	6.4 (M6)	9.7+	6.0	0.8	0411 8915 030	0411 7715 030
RS 1. 32/15	32	11/4"	6.4 (M6)	9.7+	6.0	0.8	0411 8915 032	0411 7715 032	
RS 1. 34/15	34	15/16"	6.4 (M6)	9.7+	6.0	0.8	0411 8915 034	0411 7715 034	
RS 1. 35/15	35	13/8"	6.4 (M6)	9.7+	6.0	0.8	0411 8915 035	0411 7715 035	
20	RS 1. 10/20	10	3/8"	8.4 (M8)	12.5+	8.5	0.8	0411 8920 010	0411 7720 010
	RS 1. 12/20	12	1/2"	8.4 (M8)	12.5+	8.5	0.8	0411 8920 012	0411 7720 012
	RS 1. 13/20	13	1/2"	8.4 (M8)	12.5+	8.5	0.8	0411 8920 013	0411 7720 013
	RS 1. 14/20	14	9/16"	8.4 (M8)	12.5+	8.5	0.8	0411 8920 014	0411 7720 014
	RS 1. 15/20	15	5/8"	8.4 (M8)	12.5+	8.5	0.8	0411 8920 015	0411 7720 015
	RS 1. 16/20	16	5/8"	8.4 (M8)	12.5+	8.5	0.8	0411 8920 016	0411 7720 016
	RS 1. 18/20	18	3/4"	8.4 (M8)	12.5+	8.5	0.8	0411 8920 018	0411 7720 018
	RS 1. 19/20	19	3/4"	8.4 (M8)	12.5+	8.5	0.8	0411 8920 019	0411 7720 019
	RS 1. 20/20	20	13/16"	8.4 (M8)	12.5+	8.5	0.8	0411 8920 020	0411 7720 020
	RS 1. 22/20	22	7/8"	8.4 (M8)	12.5+	8.5	0.8	0411 8920 022	0411 7720 022
	RS 1. 23/20	23	7/8"	8.4 (M8)	12.5+	8.5	0.8	0411 8920 023	0411 7720 023
	RS 1. 24/20	24	15/16"	8.4 (M8)	12.5+	8.5	0.8	0411 8920 024	0411 7720 024
	RS 1. 25/20	25	1"	8.4 (M8)	12.5+	8.5	0.8	0411 8920 025	0411 7720 025
	RS 1. 28/20	28	11/8"	8.4 (M8)	12.5+	8.5	0.8	0411 8920 028	0411 7720 028
	RS 1. 30/20	30	13/16"	8.4 (M8)	12.5+	8.5	1.0	0411 8920 030	0411 7720 030
	RS 1. 32/20	32	11/4"	8.4 (M8)	12.5+	8.5	1.0	0411 8920 032	0411 7720 032
	RS 1. 34/20	34	15/16"	8.4 (M8)	12.5+	8.5	1.0	0411 8920 034	0411 7720 034
	RS 1. 35/20	35	13/8"	8.4 (M8)	12.5+	8.5	1.0	0411 8920 035	0411 7720 035
RS 1. 36/20	36	17/16"	8.4 (M8)	12.5+	8.5	1.0	0411 8920 036	0411 7720 036	
RS 1. 38/20	38	11/2"	8.4 (M8)	12.5+	8.5	1.0	0411 8920 038	0411 7720 038	
RS 1. 40/20	40	19/16"	8.4 (M8)	12.5+	8.5	1.0	0411 8920 040	0411 7720 040	

Band width 9 mm and 25 mm available as standard
Additional diameters available on request



RS 0



NORMAFIX® RS 0				
Band width in mm	Min. Clamping range (mm)	Thickness (mm)		
		W1	W3	W5
9	5	0.4	0.4	0.4
12	5	0.5	0.5	0.5
15	8	... ø 14 = 0.6 from ø 15 = 0.8	0.6	0.6
20	15	... ø 25 = 0.8 from ø 26 = 1.0	0.8	0.8
25	20	... ø 49 = 1.0 from ø 50 = 1.25	1.0	1.0

Available on request



Refer to page 194

RS 2



NORMAFIX® RS 2				
Band width in mm	Min. Clamping range (mm)	Thickness (mm)		
		W1	W3	W5
9	5	0.4	0.4	0.4
12	5	0.5	0.5	0.5
15	8	... ø 14 = 0.6 from ø 15 = 0.8	0.6	0.6
20	15	... ø 25 = 0.8 from ø 26 = 1.0	0.8	0.8
25	20	... ø 49 = 1.0 from ø 50 = 1.25	1.0	1.0

Available on request



Refer to page 194

RSV 1



The NORMAFIX® RSV 1 can be pre-positioned on the hose. The locking device keeps the RSV 1 safely in place if it needs to be stocked or transported prior to its final assembly.

Available in band widths of 15 and 20 mm, in the same dimensions as our RS 1. This system can only be fixed by using a special tool.

Advantages at a glance

- Safe pre-assembly on the hose
- No unintentional opening of the clamp during handling or transportation

Materials

W1, W3, W4, W5



Refer to page 194

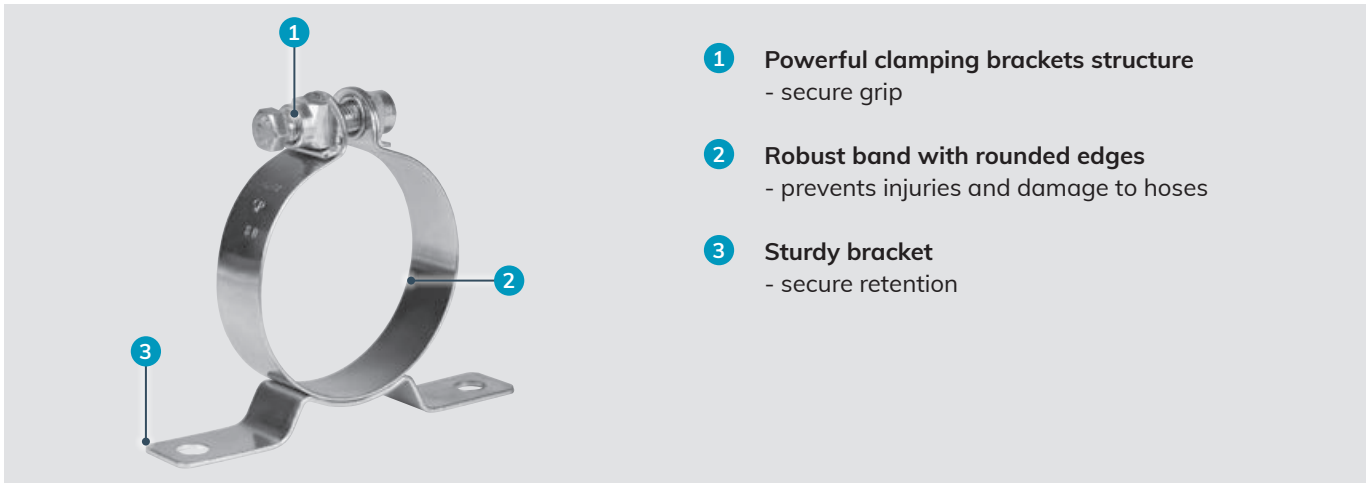

- 1 Powerful clamping brackets structure**
- secure grip
- 2 Robust band with rounded edges**
- prevents injuries and damage to hoses
- 3 Sturdy bracket**
- secure retention

Retaining clamps with brackets

NORMAFIX® HMK retaining clamps with brackets are used when high mechanical force is needed for retaining containers or pipes on ceilings and walls as well as in machine building and plant construction applications.

Standard design

This version features an “open” bracket, making it suitable for all applications in which relatively light structures are being retained and which are subject to low mechanical loads. The standard version of the retaining clamps is available in one or two parts, and with band widths of 15, 20 and 25 mm.

These clamps can be fitted with a rubber profile for shock absorption purposes. The rubber profile simultaneously protects against the ingress of creeping water.

Advantages at a glance

- ✓ For high mechanical force
- ✓ Stable construction
- ✓ Chromium (VI)-free surface

Applications

- Machine building
- Chemical industry
- Irrigation systems
- Ship manufacturing
- Food and beverage industry
- Railway industry
- Agricultural machines
- Building machines
- Engine manufacturing
- Pump and filter
- Mining industry

Materials

W1	W2	W3	W4	W5
x			x	x

Rubber profiles

The rubber profiles are available in EPDM (type a) and silicone (type b) material versions.

B = band width of clamp in mm
 b₁ = width in mm
 s₂ = material thickness in mm

All clamps with rubber profiles are pre-assembled. The complete clamps are supplied ready for use.

When submitting requests/orders for NORMAFIX® HMK retaining clamps with brackets, please specify which rubber profile you require.

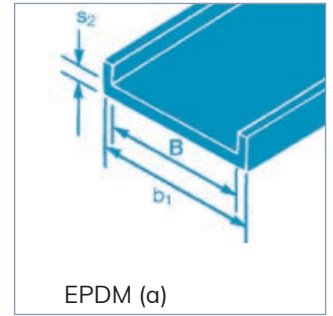
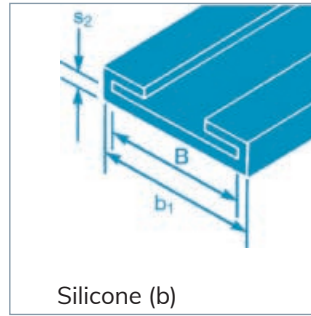

B	b ₁ ≈	s ₂
15	18.5	1.5
20	25	2.0
25	31	3.0
30	36	3.0

Technical data & Ordering information



NORMAFIX® HMK (standard design)												
Band width in mm	Designation	Min. ø in mm	Min. ø in in.	Bolts			d in mm	Rubber profile		s in mm		Part Group
				Sz	Sk	Dimensions		Silicone	EPDM	W1	W5	
15	HMK STANDARD 25/15	25	1	x		M6 x 30	6.5	x	x	0.8	0.6	1416
20	HMK STANDARD 30/20	30	1 3/16	x		M8 x 40	8.5	x	x	1.0-1.5	0.8	1516
25	HMK STANDARD 50/25	50	2		x	M10 x 45	11	x	x	1.5	1.0	1616

When submitting requests and orders, please specify the data in the following manner:

	1. Type	2. Parts	3. Diameter	4. Band width	5. Bolt	6. Material
Example	HMK STANDARD	1616	80	25	SK	W1

Single-part heavy duty



The NORMACLAMP® HMK single-part heavy duty is suitable for applications with high mechanical loads and for retaining extremely heavy pipes and connectors.

Advantages at a glance

- Stable construction
- Chromium (VI)-free surface
- EPDM Rubber profile

Materials

W1, W4

Two-parts heavy duty



In the NORMACLAMP® HMK two-parts heavy duty version, the ends of the brackets are folded back and spot-welded onto the band.

Advantages at a glance

- Stable construction
- Chromium (VI)-free surface
- EPDM Rubber profile
- Two-parts clamp for bigger clamping range
- Suitable for larger hoses

Materials

W1, W4

K1



The NORMACLAMP® HMK K1 are prefabricated brackets which you can use to transform NORMACLAMP® standard clamps (types GBS, HD, SP and TORRO) into retaining clamps with brackets in no time at all. Just open the standard clamp, guide the band through the bracket slot, and that's all there is to it.

Advantages at a glance

- Suitable for many clamp versions
- Easy to use

Material

W1

REINFORCED PIPE CLAMP / ISOPHONIC PIPE CLAMP



Two Pipe Clamp models at your choice

NORMAFIX® Reinforced Pipe Clamp / Isophonic Pipe Clamp enables pipes to be attached to walls quickly and easily.

Advantages at a glance

- ✓ Full range up to 1250 mm pipe diameter
- ✓ Captive side screws remain in place during clamp and pipe installation
- ✓ Dual terminal nut for both M8 and M10 screw
- ✓ Rubber profile for noise and vibration insulation

Applications

The NORMAFIX® Reinforced Pipe Clamp / Isophonic Pipe Clamp fixes pipes of different diameters to building structures such as walls and ceilings. The pipe clamp consists of two halves, where one half has a dual terminal nut suitable for M8 and M10 screws, for wall/ceiling mounting. The other half secures the pipe in place.

Materials

W1	W2	W3	W4	W5
x			x	x

Technical data & Ordering information

NORMAFIX® PIPE CLAMP						
Designation	Ø D in mm	Clamping range in mm	Band in mm	Screw	W1 without rubber Product No.	W1 with rubber Product No.
PIPE CLAMP M8+M10/18 W1	18	17-20	20x2	M6x16	0893 7111 018	0893 7121 018
PIPE CLAMP M8+M10/22 W1	22	20-25	20x2	M6x16	0893 7111 022	0893 7121 022
PIPE CLAMP M8+M10/28 W1	28	26-30	20x2	M6x16	0893 7111 028	0893 7121 028
PIPE CLAMP M8+M10/35 W1	35	32-36	20x2	M6x16	0893 7111 035	0893 7121 035
PIPE CLAMP M8+M10/40 W1	40	38-45	20x2	M6x16	0893 7111 040	0893 7121 040
PIPE CLAMP M8+M10/48 W1	48	47-51	20x2	M6x20	0893 7111 048	0893 7121 048
PIPE CLAMP M8+M10/54 W1	54	53-58	20x2	M6x20	0893 7111 054	0893 7121 054
PIPE CLAMP M8+M10/60 W1	60	60-64	20x2	M6x20	0893 7111 060	0893 7121 060
PIPE CLAMP M8+M10/70 W1	70	68-72	20x2	M6x20	0893 7111 070	0893 7121 070
PIPE CLAMP M8+M10/75 W1	75	74-80	20x2	M6x20	0893 7111 075	0893 7121 075
PIPE CLAMP M8+M10/84 W1	84	81-86	20x2	M6x20	0893 7111 084	0893 7121 084
PIPE CLAMP M8+M10/90 W1	90	87-92	20x2	M6x20	0893 7111 090	0893 7121 090
PIPE CLAMP M8+M10/100 W1	100	99-105	20x2	M6x20	0893 7111 100	0893 7121 100
PIPE CLAMP M8+M10/110 W1	110	107-112	20x2	M6x25	0893 7111 110	0893 7121 110
PIPE CLAMP M8+M10/115 W1	115	113-118	20x2	M6x25	0893 7111 115	0893 7121 115
PIPE CLAMP M8+M10/125 W1	125	125-130	20x2	M6x25	0893 7111 125	0893 7121 125
PIPE CLAMP M8+M10/133 W1	133	131-137	20x2	M6x25		0893 7121 133
PIPE CLAMP M8+M10/140 W1	140	138-142	20x2	M6x25	0893 7111 140	0893 7121 140
PIPE CLAMP M8+M10/150 W1	150	148-152	20x2	M6x25	0893 7111 150	0893 7121 150
PIPE CLAMP M8+M10/160 W1	160	159-166	20x2	M6x25	0893 7111 160	0893 7121 160
PIPE CLAMP M8+M10/180 W1	180	179-184	20x2	M6x25	0893 7111 180	0893 7121 180
PIPE CLAMP M8+M10/200 W1	200	200-205	28x2	M6x25	0893 7111 200	0893 7121 200
PIPE CLAMP M8+M10/220 W1	220	215-220	28x2	M6x30	0893 7111 220	0893 7121 220
PIPE CLAMP M8+M10/225 W1	225	223-228	28x2	M6x30	0893 7111 225	0893 7121 225
PIPE CLAMP M8+M10/250 W1	250	249-254	28x2	M6x30	0893 7111 250	0893 7121 250
PIPE CLAMP M8+M10/280 W1	280	279-284	28x2	M6x30	0893 7111 280	0893 7121 280
PIPE CLAMP M8+M10/300 W1	300	299-304	28x2	M6x30	0893 7111 300	0893 7121 300
PIPE CLAMP M8+M10/315 W1	315	314-319	28x2	M6x30	0893 7111 315	0893 7121 315
PIPE CLAMP M8+M10/350 W1	350	349-354	28x2	M6x30	0893 7111 350	0893 7121 350
PIPE CLAMP M8+M10/400 W1	400	399-406	28x2	M6x30	0893 7111 400	0893 7121 400
PIPE CLAMP M8+M10/450 W1	450	449-456	28x2	M6x30	0893 7111 450	0893 7121 450
PIPE CLAMP M8+M10/500 W1	500	499-506	28x2	M6x30	0893 7111 500	0893 7121 500
PIPE CLAMP M8+M10/560 W1	560	559-568	28x2.5	M6x30	0893 7111 560	0893 7121 560
PIPE CLAMP M8+M10/600 W1	600	599-608	28x2.5	M6x30	0893 7111 600	0893 7121 600
PIPE CLAMP M8+M10/630 W1	630	629-636	28x2.5	M6x30	0893 7111 630	0893 7121 630
PIPE CLAMP M8+M10/650 W1	650	649-656	28x2.5	M6x30	0893 7111 650	
PIPE CLAMP M8+M10/700 W1	700	699-706	28x2.5	M6x30	0893 7111 700	
PIPE CLAMP M8+M10/710 W1	710	709-716	28x2.5	M6x30		0893 7121 710
PIPE CLAMP M8+M10/800 W1	800	799-806	28x2.5	M6x30	0893 7111 800	
PIPE CLAMP M8+M10/900 W1	900	899-906	28x2.5	M6x30	0893 7111 900	
PIPE CLAMP M8+M101000 W1	1000	999-1006	28x2.5	M6x30	0893 7111 901	
PIPE CLAMP M8+M10/1100 W1	1100	1099-1106	28x2.5	M6x30	0893 7111 902	
PIPE CLAMP M8+M10/1200 W1	1200	1199-1206	28x2.5	M6x30	0893 7111 903	
PIPE CLAMP M8+M10/1250 W1	1250	1249-1256	28x2.5	M6x30	0893 7111 904	

REINFORCED PIPE CLAMP / ISOPHONIC PIPE CLAMP

NORMAFIX® PIPE CLAMP						
Designation	Ø D in mm	Clamping range in mm	Band in mm	Screw	W4 without rubber Product No.	W4 with rubber Product No.
PIPE CLAMP M8+M10/18 W4	18	16-20	20x2	M6x16	0893 7114 018	0893 7124 018
PIPE CLAMP M8+M10/22 W4	22	21-26	20x2	M6x16	0893 7114 022	0893 7124 022
PIPE CLAMP M8+M10/28 W4	28	26-31	20x2	M6x16	0893 7114 028	0893 7124 028
PIPE CLAMP M8+M10/35 W4	35	33-38	20x2	M6x16	0893 7114 035	0893 7124 035
PIPE CLAMP M8+M10/40 W4	40	40-45	20x2	M6x16	0893 7114 040	0893 7124 040
PIPE CLAMP M8+M10/48 W4	48	47-52	20x2	M6x20	0893 7114 048	0893 7124 048
PIPE CLAMP M8+M10/54 W4	54	52-57	20x2	M6x20	0893 7114 054	0893 7124 054
PIPE CLAMP M8+M10/60 W4	60	60-65	20x2	M6x20	0893 7114 060	0893 7124 060
PIPE CLAMP M8+M10/70 W4	70	68-72	20x2	M6x20	0893 7114 070	0893 7121 070
PIPE CLAMP M8+M10/75 W4	75	72-77	20x2	M6x20	0893 7114 075	0893 7124 075
PIPE CLAMP M8+M10/84 W4	84	81-86	20x2	M6x20	0893 7114 084	0893 7124 084
PIPE CLAMP M8+M10/90 W4	90	87-94	20x2	M6x20	0893 7114 090	0893 7124 090
PIPE CLAMP M8+M10/104 W4	104	98-105	20x2	M6x20	0893 7114 104	0893 7124 100
PIPE CLAMP M8+M10/110 W4	110	107-114	20x2	M6x25	0893 7114 110	0893 7124 110
PIPE CLAMP M8+M10/115 W4	115	111-118	20x2	M6x25	0893 7114 115	0893 7124 115
PIPE CLAMP M8+M10/125 W4	125	121-128	20x2	M6x25	0893 7114 125	0893 7124 125
PIPE CLAMP M8+M10/133 W4	133	132-137	20x2	M6x25	0893 7114 133	0893 7124 133
PIPE CLAMP M8+M10/140 W4	140	133-140	20x2	M6x25	0893 7114 140	0893 7124 140
PIPE CLAMP M8+M10/150 W4	150	147-155	20x2	M6x25	0893 7114 150	0893 7124 150
PIPE CLAMP M8+M10/160 W4	160	158-170	20x2	M6x25	0893 7114 160	0893 7124 160
PIPE CLAMP M8+M10/180 W4	180	177-184	20x2	M6x25	0893 7114 180	0893 7124 180
PIPE CLAMP M8+M10/204 W4	204	198-210	28x2	M6x25	0893 7114 204	0893 7124 204
PIPE CLAMP M8+M10/220 W4	220	215-220	28x2	M6x30	0893 7114 220	0893 7124 220
PIPE CLAMP M8+M10/225 W4	225	223-228	28x2	M6x30	0893 7114 225	0893 7124 225
PIPE CLAMP M8+M10/250 W4	250	249-254	28x2	M6x30	0893 7114 250	0893 7124 250
PIPE CLAMP M8+M10/280 W4	280	279-284	28x2	M6x30	0893 7114 280	0893 7124 280
PIPE CLAMP M8+M10/300 W4	300	299-304	28x2	M6x30	0893 7114 300	0893 7124 300
PIPE CLAMP M8+M10/315 W4	315	314-319	28x2	M6x30	0893 7114 315	0893 7124 315
PIPE CLAMP M8+M10/350 W4	350	354-359	28x2	M6x30	0893 7114 350	0893 7124 350
PIPE CLAMP M8+M10/400 W4	400	399-406	28x2	M6x30	0893 7114 400	
PIPE CLAMP M8+M10/500 W4	500	499-506	28x2	M6x30	0893 7114 500	

REINFORCED PIPE CLAMP / ISOPHONIC PIPE CLAMP

NORMAFIX® PIPE CLAMP						
Designation	Ø D in mm	Clamping range in mm	Band in mm	Screw	W5 without rubber Product No.	W5 with rubber Product No.
PIPE CLAMP M8+M10/18 W5	18	16-20	20x2	M6x16	0893 7115 018	0893 7125 018
PIPE CLAMP M8+M10/22 W5	22	21-26	20x2	M6x16	0893 7115 022	0893 7125 022
PIPE CLAMP M8+M10/28 W5	28	26-31	20x2	M6x16	0893 7115 028	0893 7125 028
PIPE CLAMP M8+M10/35 W5	35	33-38	20x2	M6x16	0893 7115 035	0893 7125 035
PIPE CLAMP M8+M10/40 W5	40	40-45	20x2	M6x16	0893 7115 040	0893 7125 040
PIPE CLAMP M8+M10/48 W5	48	47-52	20x2	M6x20	0893 7115 048	0893 7125 048
PIPE CLAMP M8+M10/54 W5	54	52-57	20x2	M6x20	0893 7115 054	0893 7125 054
PIPE CLAMP M8+M10/60 W5	60	60-65	20x2	M6x20	0893 7115 060	0893 7125 060
PIPE CLAMP M8+M10/70 W5	70	68-72	20x2	M6x20	0893 7115 070	0893 7121 070
PIPE CLAMP M8+M10/75 W5	75	72-77	20x2	M6x20	0893 7115 075	0893 7125 075
PIPE CLAMP M8+M10/84 W5	84	81-86	20x2	M6x20	0893 7115 084	0893 7125 084
PIPE CLAMP M8+M10/90 W5	90	87-94	20x2	M6x20	0893 7115 090	0893 7125 090
PIPE CLAMP M8+M10/100 W5	104	98-105	20x2	M6x20	0893 7115 100	0893 7125 100
PIPE CLAMP M8+M10/110 W5	110	107-114	20x2	M6x25	0893 7115 110	0893 7125 110
PIPE CLAMP M8+M10/115 W5	115	111-118	20x2	M6x25	0893 7115 115	0893 7125 115
PIPE CLAMP M8+M10/125 W5	125	121-128	20x2	M6x25	0893 7115 125	0893 7125 125
PIPE CLAMP M8+M10/133 W5	133	132-137	20x2	M6x25	0893 7115 133	0893 7125 133
PIPE CLAMP M8+M10/140 W5	140	133-140	20x2	M6x25	0893 7115 140	0893 7125 140
PIPE CLAMP M8+M10/150 W5	150	147-155	20x2	M6x25	0893 7115 150	0893 7125 150
PIPE CLAMP M8+M10/160 W5	160	158-170	20x2	M6x25	0893 7115 160	0893 7125 160
PIPE CLAMP M8+M10/180 W5	180	177-184	20x2	M6x25	0893 7115 180	0893 7125 180
PIPE CLAMP M8+M10/204 W5	204	198-210	28x2	M6x25	0893 7115 204	0893 7125 204
PIPE CLAMP M8+M10/220 W5	220	215-220	28x2	M6x30	0893 7115 220	0893 7125 220
PIPE CLAMP M8+M10/225 W5	225	223-228	28x2	M6x30	0893 7115 225	0893 7125 225
PIPE CLAMP M8+M10/250 W5	250	249-254	28x2	M6x30	0893 7115 250	0893 7125 250
PIPE CLAMP M8+M10/280 W5	280	279-284	28x2	M6x30	0893 7115 280	0893 7125 280
PIPE CLAMP M8+M10/300 W5	300	299-304	28x2	M6x30	0893 7115 300	0893 7125 300
PIPE CLAMP M8+M10/315 W5	315	314-319	28x2	M6x30	0893 7115 315	0893 7125 315
PIPE CLAMP M8+M10/350 W5	350	354-359	28x2	M6x30	0893 7115 350	0893 7125 350
PIPE CLAMP M8+M10/400 W5	400	399-406	28x2	M6x30	0893 7115 400	
PIPE CLAMP M8+M10/500 W5	500	499-506	28x2	M6x30	0893 7115 500	

U-BOLT CLAMP

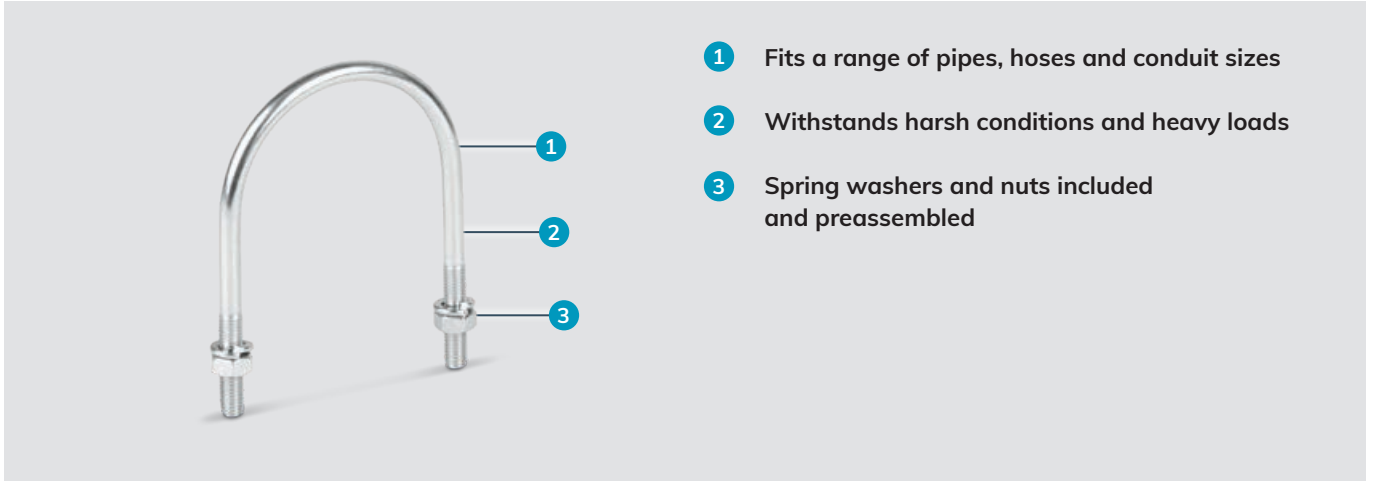

Keep simple things simple series

The NORMAFIX® U-Bolt Clamps are U shaped, bent bolts with threads at both ends. A wide clamping range from 18 mm-350 mm is available. It is available both with carbon steel and stainless steel materials (AISI 304, AISI 316).

Advantages at a glance

- ✓ Spring washers and nuts included
- ✓ Available in carbon steel and stainless steel
- ✓ Ready to install with improved locking capabilities
- ✓ Suitable for inside and outside installations

Applications

The NORMAFIX® U-Bolt Clamp has a vast range of applications. For example, it is used in buildings, constructions and as an anchor for foundations, roofs, pipes and conduit holders.

Materials

W1	W2	W3	W4	W5
x			x	x

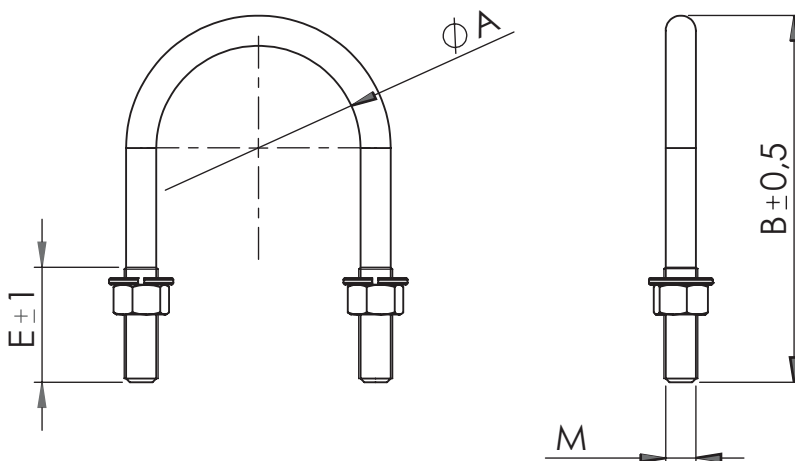

Technical data & Ordering information

NORMAFIX® U-BOLT CLAMP							
Designation	Measures				W1 Product No.	W4 Product No.	W5 Product No.
	∅ (A) mm	(mm) (B)	(mm) E	M			
U-BOLT CLAMP 18	18	50	35	M6	0893 7211 018	0893 7214 018	0893 7215 018
U-BOLT CLAMP 22	22	53	35	M6	0893 7211 022	0893 7214 022	0893 7215 022
U-BOLT CLAMP 28	28	59	35	M6	0893 7211 028	0893 7214 028	0893 7215 028
U-BOLT CLAMP 34	34	65	35	M6	0893 7211 034	0893 7214 034	0893 7215 034
U-BOLT CLAMP 39	39	70	35	M6	0893 7211 039	0893 7214 039	0893 7215 039
U-BOLT CLAMP 43	43	74	35	M6	0893 7211 043	0893 7214 043	0893 7215 043
U-BOLT CLAMP 49	49	85	40	M8	0893 7211 049	0893 7214 049	0893 7215 049
U-BOLT CLAMP 54	54	96	40	M8	0893 7211 054	0893 7214 054	0893 7215 054
U-BOLT CLAMP 55	55	97	40	M8	0893 7211 055	0893 7214 055	0893 7215 055
U-BOLT CLAMP 61	61	99	40	M8	0893 7211 061	0893 7214 061	0893 7215 061
U-BOLT CLAMP 66	66	98	40	M8	0893 7211 066	0893 7214 066	0893 7215 066
U-BOLT CLAMP 71	71	102	40	M8	0893 7211 071	0893 7214 071	0893 7215 071
U-BOLT CLAMP 77	77	113	40	M8	0893 7211 077	0893 7214 077	0893 7215 077
U-BOLT CLAMP 85	85	117	40	M8	0893 7211 085	0893 7214 085	0893 7215 085
U-BOLT CLAMP 90	90	126	40	M8	0893 7211 090	0893 7214 090	0893 7215 090
U-BOLT CLAMP 105	105	149	40	M10	0893 7211 105	0893 7214 105	0893 7215 105
U-BOLT CLAMP 115	115	155	40	M10	0893 7211 115	0893 7214 115	0893 7215 115
U-BOLT CLAMP 130	130	170	40	M10	0893 7211 130	0893 7214 130	0893 7215 130
U-BOLT CLAMP 144	144	184	40	M10	0893 7211 144	0893 7214 144	0893 7215 144
U-BOLT CLAMP 155	155	194	40	M10	0893 7211 155	0893 7214 155	0893 7215 155
U-BOLT CLAMP 170	170	210	40	M10	0893 7211 170	0893 7214 170	0893 7215 170
U-BOLT CLAMP 206	206	244	40	M10	0893 7211 206	0893 7214 206	0893 7215 206
U-BOLT CLAMP 221	221	259	40	M10	0893 7211 221	0893 7214 221	0893 7215 221
U-BOLT CLAMP 256	256	294	40	M10	0893 7211 256	0893 7214 256	0893 7215 256
U-BOLT CLAMP 275	275	313	40	M10	0893 7211 275	0893 7214 275	0893 7215 275
U-BOLT CLAMP 306	306	344	50	M10	0893 7211 306	0893 7214 306	0893 7215 306
U-BOLT CLAMP 324	324	368	50	M10	0893 7211 324	0893 7214 324	0893 7215 324
U-BOLT CLAMP 354	354	407	50	M10	0893 7211 354	0893 7214 354	0893 7215 354

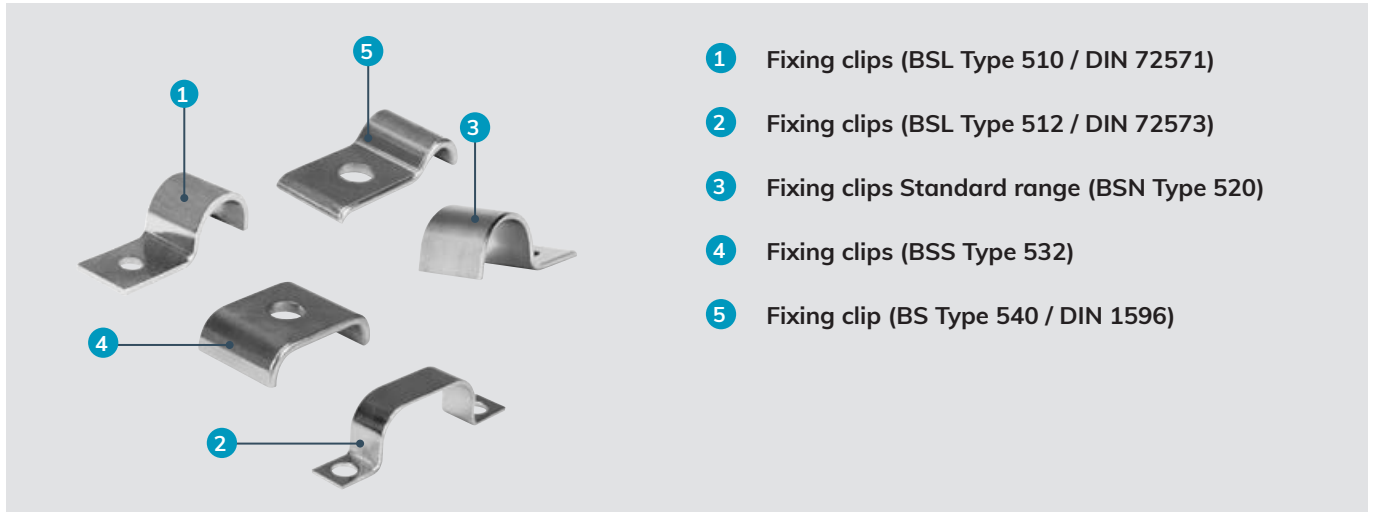

- 1 Fixing clips (BSL Type 510 / DIN 72571)
- 2 Fixing clips (BSL Type 512 / DIN 72573)
- 3 Fixing clips Standard range (BSN Type 520)
- 4 Fixing clips (BSS Type 532)
- 5 Fixing clip (BS Type 540 / DIN 1596)

Fixing clips

NORMAFIX® BSL / BSN / BSS / BS fixing clips enable pipes, cables and cable protection pipes to be attached to structures quickly and easily. They are suitable for all industrial Anwendungen which require a low-priced yet reliable attachment solution.

Vorteile auf einen Blick

- ✓ Sturdy band design and precise fit
- ✓ Components are retained securely and with ease
- ✓ Band Bandbreite from 4 to 61 mm depending on the version
- ✓ Material Stärke from 1 to 4 mm depending on the version
- ✓ Multiple versions for different Anwendungen

Werkstoffe

W1	W2	W3	W4	W5
x				

BSL type 510 for 1 line

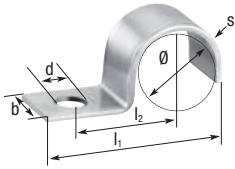

NORMAFIX® BSL TYPE 510 FOR 1 LINE (in accordance with DIN 72571)								
Width b in mm	Designation	Clamping ranges		l ₁ in mm	l ₂ in mm	Bore hole in mm d	Mat. thickness in mm s	W1 Product No.
		in mm	in inches					
10	BSL 510 1 x 4	4	3/16"	18	9	4.8	1	0510 8980 104
	BSL 510 1 x 5	5	3/16"	18.5	9	4.8	1	0510 8980 105
	BSL 510 1 x 6	6	1/4"	20	10	4.8	1	0510 8980 106
	BSL 510 1 x 7	7	1/4"	20.5	10	4.8	1	0510 8980 107
	BSL 510 1 x 8	8	5/16"	22	11	4.8	1	0510 8980 108
	BSL 510 1 x 9	9	3/8"	22.5	11	4.8	1	0510 8980 109
12	BSL 510 1 x 10	10	3/8"	23	11	4.8	1	0510 8980 110
	BSL 510 1 x 11	11	7/16"	30	15	5.8	1.5	0510 8980 111
	BSL 510 1 x 12	12	1/2"	30.5	16	5.8	1.5	0510 8980 112
	BSL 510 1 x 15	15	9/16"	34	18	5.8	1.5	0510 8980 115
	BSL 510 1 x 16	16	5/8"	35	18	5.8	1.5	0510 8980 116
	BSL 510 1 x 18	18	11/16"	35.5	18	7	1.5	0510 8980 118
	BSL 510 1 x 20	20	13/16"	37.5	19	7	1.5	0510 8980 120
	BSL 510 1 x 22	22	7/8"	39.5	20	7	1.5	0510 8980 122
BSL 510 1 x 24	24	15/16"	41.5	21	7	1.5	0510 8980 124	

BSL type 510 for 2 lines

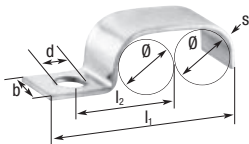

NORMAFIX® BSL TYPE 510 FOR 2 LINES (in accordance with DIN 72571)								
Width b in mm	Designation	Clamping ranges		l ₁ in mm	l ₂ in mm	Bore hole in mm d	Mat. thickness in mm s	W1 Product No.
		in mm	in inches					
10	BSL 510 2 x 4	4	3/16"	22.5	11	4.8	1	0510 8980 204
	BSL 510 2 x 5	5	3/16"	24	11.5	4.8	1	0510 8980 205
	BSL 510 2 x 6	6	1/4"	26.5	13	4.8	1	0510 8980 206
	BSL 510 2 x 7	7	1/4"	28	13.5	4.8	1	0510 8980 207
	BSL 510 2 x 8	8	5/16"	30.5	15	4.8	1	0510 8980 208
	BSL 510 2 x 10	10	3/8"	33.5	16	4.8	1	0510 8980 210
12	BSL 510 2 x 12	12	1/2"	43	22	5.8	1.5	0510 8980 212
	BSL 510 2 x 15	15	9/16"	49	25.3	5.8	1.5	0510 8980 215

BSL type 512 for 1 line

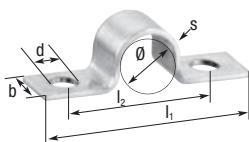

NORMAFIX® BSL TYPE 512 FOR 1 LINE (in accordance with DIN 72573)								
Width b in mm	Designation	Clamping ranges		l ₁ in mm	l ₂ in mm	Bore hole in mm d	Mat. thickness in mm s	W1 Product No.
		in mm	in inches					
10	BSL 512 1 x 4	4	3/16"	29	17	4.8	1	0512 8980 104
	BSL 512 1 x 5	5	3/16"	30	18	4.8	1	0512 8980 105
	BSL 512 1 x 6	6	1/4"	32	20	4.8	1	0512 8980 106
	BSL 512 1 x 7	7	1/4"	32	20	4.8	1	0512 8980 107
	BSL 512 1 x 8	8	5/16"	34	22	4.8	1	0512 8980 108
	BSL 512 1 x 10	10	3/8"	34	22	4.8	1	0512 8980 110
12	BSL 512 1 x 12	12	1/2"	46	32	5.8	1.5	0512 8980 112
	BSL 512 1 x 15	15	9/16"	50	36	5.8	1.5	0512 8980 115
	BSL 512 1 x 18	18	11/16"	50	36	7	1.5	0512 8980 118
	BSL 512 1 x 20	20	13/16"	52	38	7	1.5	0512 8980 120
	BSL 512 1 x 22	22	7/8"	54	40	7	1.5	0512 8980 122

BSL – VERSIONS

BSL type 512 for 2 lines

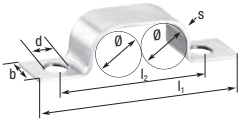

NORMAFIX® BSL TYPE 512 FOR 2 LINES (in accordance with DIN 72573)								
Width b in mm	Designation	Clamping ranges		l ₁ in mm	l ₂ in mm	Bore hole in mm d	Mat. thickness in mm s	W1 Product No.
		in mm	in inches					
10	BSL 512 2 x 4	4	3/16"	33	21	4.8	1	0512 8980 204
	BSL 512 2 x 5	5	3/16"	35	23	4.8	1	0512 8980 205
	BSL 512 2 x 6	6	1/4"	38	26	4.8	1	0512 8980 206
	BSL 512 2 x 7	7	1/4"	39	27	4.8	1	0512 8980 207
	BSL 512 2 x 8	8	5/16"	42	30	4.8	1	0512 8980 208
	BSL 512 2 x 10	10	3/8"	44	32	4.8	1	0512 8980 210
12	BSL 512 2 x 12	12	1/2"	58	44	5.8	1.5	0512 8980 212
	BSL 512 2 x 15	15	9/16"	66	52	5.8	1.5	0512 8980 215
	BSL 512 2 x 18	18	11/16"	69	55	7	1.5	0512 8980 218
	BSL 512 2 x 20	20	13/16"	73	59	7	1.5	0512 8980 220
	BSL 512 2 x 22	22	7/8"	77	63	7	1.5	0512 8980 222

BSL type 512 for 3 lines



NORMAFIX® BSL TYPE 512 FOR 3 LINES (in accordance with DIN 72573)								
Width b in mm	Designation	Clamping ranges		l ₁ in mm	l ₂ in mm	Bore hole in mm d	Mat. thickness in mm s	W1 Product No.
		in mm	in inches					
10	BSL 512 3 x 4	4	3/16"	39	27	4.8	1	0512 8980 304
	BSL 512 3 x 5	5	3/16"	41	29	4.8	1	0512 8980 305
	BSL 512 3 x 6	6	1/4"	45	33	4.8	1	0512 8980 306
	BSL 512 3 x 7	7	1/4"	47	35	4.8	1	0512 8980 307
	BSL 512 3 x 8	8	5/16"	51	39	4.8	1	0512 8980 308
	BSL 512 3 x 10	10	3/8"	55	43	4.8	1	0512 8980 310
12	BSL 512 3 x 12	12	1/2"	71	57	5.8	1.5	0512 8980 312
	BSL 512 3 x 15	15	9/16"	81	67	5.8	1.5	0512 8980 315
	BSL 512 3 x 18	18	11/16"	87	73	7	1.5	0512 8980 318
	BSL 512 3 x 20	20	13/16"	93	79	7	1.5	0512 8980 320
	BSL 512 3 x 22	22	7/8"	99	85	7	1.5	0512 8980 322

BSL type 512 for 4 lines



NORMAFIX® BSL TYPE 512 FOR 4 LINES (in accordance with DIN 72573)								
Width b in mm	Designation	Clamping ranges		l ₁ in mm	l ₂ in mm	Bore hole in mm d	Mat. thickness in mm s	W1 Product No.
		in mm	in inches					
10	BSL 512 4 x 4	4	3/16"	29	17	4.8	1	0512 8980 404
	BSL 512 4 x 5	5	3/16"	30	18	4.8	1	0512 8980 405
	BSL 512 4 x 6	6	1/4"	32	20	4.8	1	0512 8980 406
	BSL 512 4 x 7	7	1/4"	32	20	4.8	1	0512 8980 407
	BSL 512 4 x 8	8	5/16"	34	22	4.8	1	0512 8980 408
	BSL 512 4 x 10	10	3/8"	34	22	4.8	1	0512 8980 410
12	BSL 512 4 x 12	12	1/2"	46	32	5.8	1.5	0512 8980 412
	BSL 512 4 x 15	15	9/16"	50	36	5.8	1.5	0512 8980 415
	BSL 512 4 x 18	18	11/16"	50	36	7	1.5	0512 8980 418
	BSL 512 4 x 20	20	13/16"	52	38	7	1.5	0512 8980 420
	BSL 512 4 x 22	22	7/8"	54	40	7	1.5	0512 8980 422

BSL type 512 for 5 lines



NORMAFIX® BSL TYPE 512 FOR 5 LINES (in accordance with DIN 72573)								
Width b in mm	Designation	Clamping ranges		l ₁ in mm	l ₂ in mm	Bore hole in mm d	Mat. thickness in mm s	W1 Product No.
		in mm	in inches					
10	BSL 512 5 x 4	4	3/16"	48	36	4.8	1	0512 8980 504
	BSL 512 5 x 5	5	3/16"	53	41	4.8	1	0512 8980 505
	BSL 512 5 x 6	6	1/4"	57	45	4.8	1	0512 8980 506
	BSL 512 5 x 7	7	1/4"	63	51	4.8	1	0512 8980 507
	BSL 512 5 x 8	8	5/16"	68	56	4.8	1	0512 8980 508
	BSL 512 5 x 10	10	3/8"	77	65	4.8	1	0512 8980 510
12	BSL 512 5 x 12	12	1/2"	95	81	5.8	1.5	0512 8980 512

BSL type 512 for 6 lines



NORMAFIX® BSL TYPE 512 FOR 6 LINES (in accordance with DIN 72573)								
Width b in mm	Designation	Clamping ranges		l ₁ in mm	l ₂ in mm	Bore hole in mm d	Mat. thickness in mm s	W1 Product No.
		in mm	in inches					
10	BSL 512 6 x 4	4	3/16"	52	40	4.8	1	0512 8980 604
	BSL 512 6 x 5	5	3/16"	58	46	4.8	1	0512 8980 605
	BSL 512 6 x 6	6	1/4"	64	52	4.8	1	0512 8980 606
	BSL 512 6 x 7	7	1/4"	72	60	4.8	1	0512 8980 607
	BSL 512 6 x 8	8	5/16"	76	64	4.8	1	0512 8980 608
	BSL 512 6 x 10	10	3/8"	90	78	4.8	1	0512 8980 610

BSN – VERSIONS

BSN type 520 for 1 line

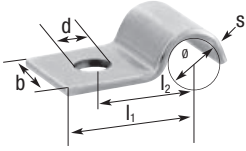

NORMAFIX® BSN TYPE 520 FOR 1 LINE								
Width b in mm	Designation	Clamping ranges		l ₁ in mm	l ₂ in mm	Bore hole in mm d	Mat. thickness in mm s	W1 Product No.
		in mm	in inches					
20	BSN 520 1 x 8	8	5/16"	26	16.5	7	2	0520 7000 008
	BSN 520 1 x 9	9	3/8"	26.5	17	7	2	0520 7000 009
	BSN 520 1 x 10	10	3/8"	26.5	17	7	2	0520 7000 010
	BSN 520 1 x 12	12	1/2"	28	18	7	2	0520 7000 012
	BSN 520 1 x 13	13	1/2"	28.5	19	7	2	0520 7000 013
	BSN 520 1 x 15	15	9/16"	28.5	19	7	2	0520 7000 015
	BSN 520 1 x 18	18	11/16"	30	21.5	7	2	0520 7000 018
	BSN 520 1 x 19	19	3/4"	30.5	22	7	2	0520 7000 019
	BSN 520 1 x 20	20	13/16"	32	22.5	7	2	0520 7000 020
	BSN 520 1 x 22	22	7/8"	35	23.5	7	2	0520 7000 022
	BSN 520 1 x 23	23	15/16"	35.5	25.5	7	2	0520 7000 023
	BSN 520 1 x 27	27	1 1/16"	37.5	27.5	7	2	0520 7000 027

BSN type 521 for 1 line

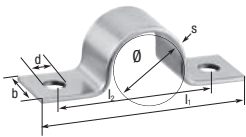

NORMAFIX® BSN TYPE 521 FOR 1 LINE								
Width b in mm	Designation	Clamping ranges		l ₁ in mm	l ₂ in mm	Bore hole in mm d	Mat. thickness in mm s	W1 Product No.
		in mm	in inches					
20	BSN 521 1 x 7	7	1/4"	44	28	7	2	0521 7000 007
	BSN 521 1 x 9	9	3/8"	48	32	7	2	0521 7000 009
	BSN 521 1 x 10	10	3/8"	49	33	7	2	0521 7000 010
	BSN 521 1 x 11	11	7/16"	50	34	7	2	0521 7000 011
	BSN 521 1 x 12	12	1/2"	51	35	7	2	0521 7000 012
	BSN 521 1 x 13	13	1/2"	53	37	7	2	0521 7000 013
	BSN 521 1 x 15	15	9/16"	56	40	7	2	0521 7000 015
	BSN 521 1 x 18	18	11/16"	59	43	7	2	0521 7000 018
	BSN 521 1 x 19	19	3/4"	60.5	44.5	7	2	0521 7000 019
	BSN 521 1 x 20	20	13/16"	65	49	7	2	0521 7000 020
	BSN 521 1 x 22	22	7/8"	67	51	7	2	0521 7000 022
	BSN 521 1 x 23	23	15/16"	68	52	7	2	0521 7000 023
	BSN 521 1 x 26	27	1"	68	52	7	2	0521 7000 027

BSN type 522 for 2 lines

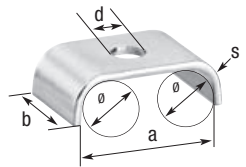

NORMAFIX® BSN TYPE 522 FOR 2 LINES							
Width b in mm	Designation	Clamping ranges		a in mm	Bore hole in mm d	Mat. thickness in mm s	W1 Product No.
		in mm	in inches				
20	BSN 522 2 x 9	9	3/8"	26	7	2	0522 7000 009
	BSN 522 2 x 10	10	3/8"	28	7	2	0522 7000 010
	BSN 522 2 x 12	12	1/2"	32	7	2	0522 7000 012
	BSN 522 2 x 13	13	1/2"	34	7	2	0522 7000 013
	BSN 522 2 x 15	15	9/16"	38	7	2	0522 7000 015
	BSN 522 2 x 18	18	11/16"	44	7	2	0522 7000 018
	BSN 522 2 x 19	19	3/4"	46	7	2	0522 7000 019
	BSN 522 2 x 20	20	13/16"	48	7	2	0522 7000 020
	BSN 522 2 x 22	22	7/8"	52	7	2	0522 7000 022

BSS type 530 for 1 line

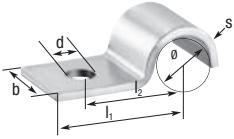

NORMAFIX® BSS TYPE 530 FOR 1 LINE								
Width b in mm	Designation	Clamping ranges		l ₁ in mm	l ₂ in mm	Bore hole in mm d	Mat. thickness in mm s	W1 Product No.
		in mm	in inches					
25	BSS 530 1 x 10	10	3/8"	28	18.5	9	3	0530 7000 010
	BSS 530 1 x 12	12	1/2"	39	24	9	3	0530 7000 012
	BSS 530 1 x 13	13	1/2"	39.5	24.5	9	3	0530 7000 013
	BSS 530 1 x 15	15	9/16"	40.5	25.5	9	3	0530 7000 015
	BSS 530 1 x 18	18	11/16"	42	28	9	3	0530 7000 018
	BSS 530 1 x 19	19	3/4"	43.5	29	9	3	0530 7000 019
	BSS 530 1 x 20	20	13/16"	44	29.5	9	3	0530 7000 020
	BSS 530 1 x 22	22	7/8"	44	29.5	9	3	0530 7000 022
	BSS 530 1 x 23	23	15/16"	44.5	30	9	3	0530 7000 023
	BSS 530 1 x 26	26	1"	52	36	9	3	0530 7000 026
	BSS 530 1 x 28.5	28.5	1 1/8"	52	36	9	3	0530 7000 028
	BSS 530 1 x 31	31	1 1/4"	56	40	9	3	0530 7000 031
	BSS 530 1 x 36	36	1 7/16"	58	41.5	9	3	0530 7000 036
	BSS 530 1 x 39	39	1 9/16"	58.5	42	9	3	0530 7000 039
BSS 530 1 x 43	43	1 11/16"	70	50	9	3	0530 7000 043	

BSS type 531 for 1 line

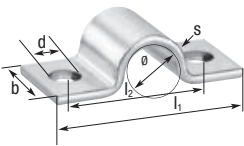

NORMAFIX® BSS TYPE 531 FOR 1 LINE								
Width b in mm	Designation	Clamping ranges		l ₁ in mm	l ₂ in mm	Bore hole in mm d	Mat. thickness in mm s	W1 Product No.
		in mm	in inches					
25	BSS 531 1 x 10	10	3/8"	28	18.5	9	3	0531 7000 010
	BSS 531 1 x 12	12	1/2"	39	24	9	3	0531 7000 012
	BSS 531 1 x 13	13	1/2"	39.5	24.5	9	3	0531 7000 013
	BSS 531 1 x 15	15	9/16"	40.5	25.5	9	3	0531 7000 015
	BSS 531 1 x 18	18	11/16"	42	28	9	3	0531 7000 018
	BSS 531 1 x 19	19	3/4"	43.5	29	9	3	0531 7000 019
	BSS 531 1 x 20	20	13/16"	44	29.5	9	3	0531 7000 020
	BSS 531 1 x 22	22	7/8"	44	29.5	9	3	0531 7000 022
	BSS 531 1 x 23	23	15/16"	44.5	30	9	3	0531 7000 023
	BSS 531 1 x 26	26	1"	52	36	9	3	0531 7000 026
	BSS 531 1 x 28.5	28.5	1 1/8"	52	36	9	3	0531 7000 028
	BSS 531 1 x 31	31	1 1/4"	56	40	9	3	0531 7000 031
	BSS 531 1 x 36	36	1 7/16"	58	41.5	9	3	0531 7000 036
	BSS 531 1 x 39	39	1 9/16"	58.5	42	9	3	0531 7000 039
BSS 531 1 x 43	43	1 11/16"	70	50	9	3	0531 7000 043	

BSS type 532 for 2 lines

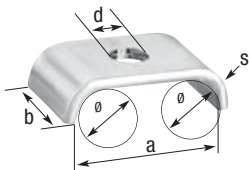

NORMAFIX® BSS TYPE 532 FOR 2 LINES							
Width b in mm	Designation	Clamping ranges		a in mm	Bore hole in mm d	Mat. thickness in mm s	W1 Product No.
		in mm	in inches				
25	BSS 532 2 x 10	10	3/8"	30	9	3	0532 7000 010
	BSS 532 2 x 12	12	1/2"	34	9	3	0532 7000 012
	BSS 532 2 x 13	13	1/2"	36	9	3	0532 7000 013
	BSS 532 2 x 15	15	9/16"	40	9	3	0532 7000 015
	BSS 532 2 x 18	18	11/16"	46	9	3	0532 7000 018
	BSS 532 2 x 20	20	13/16"	50	9	3	0532 7000 020
	BSS 532 2 x 22	22	7/8"	54	9	3	0532 7000 022
	BSS 532 2 x 23	23	15/16"	56	9	3	0532 7000 023
	BSS 532 2 x 26	26	1"	62	9	3	0532 7000 026



BS – VERSIONS

BS type 540 for 1 line

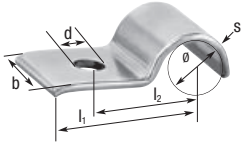

NORMAFIX® BS TYPE 540 FOR 1 LINE (in accordance with DIN 1596)								
Width b in mm	Designation	Clamping ranges		l ₁ in mm	l ₂ in mm	Bore hole in mm d	Mat. thickness in mm s	W1 Product No.
		in mm	in inches					
16	BS 540 1 x 7	7	1/4"	26	14	6.6	2	0540 7000 007
	BS 540 1 x 9	9	3/8"	28	16	6.6	2	0540 7000 009
20	BS 540 1 x 13	13	1/2"	30	18	6.6	2	0540 7000 013
	BS 540 1 x 15.5	15.5	5/8"	32	20	6.6	2	0540 7000 015
	BS 540 1 x 19	19	3/4"	34	22	6.6	2	0540 7000 019
25	BS 540 1 x 23	23	15/16"	43	28	9	3	0540 7000 023
	BS 540 1 x 26	26	1"	44	29	9	3	0540 7000 026
	BS 540 1 x 28.5	28.5	1 1/8"	47	32	9	3	0540 7000 028
	BS 540 1 x 31	31	1 1/4"	47	32	9	3	0540 7000 031
30	BS 540 1 x 33	33	1 5/16"	56	36	9	3	0540 7000 033
	BS 540 1 x 36	36	1 7/16"	57	40	11	3	0540 7000 036
	BS 540 1 x 39	39	1 9/16"	59	42	11	3	0540 7000 039
	BS 540 1 x 43	43	1 11/16"	61	44	11	3	0540 7000 043
40	BS 540 1 x 46	46	1 13/16"	62	45	11	3	0540 7000 046
	BS 540 1 x 49	49	1 15/16"	67	48	14	4	0540 7000 049
	BS 540 1 x 52	52	2 1/16"	72	53	14	4	0540 7000 052
	BS 540 1 x 58	58	2 1/4"	74	55	14	4	0540 7000 058
	BS 540 1 x 61	61	2 3/8"	77	58	14	4	0540 7000 061

BS type 541 for 1 line

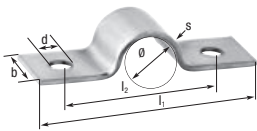

NORMAFIX® BS TYPE 541 FOR 1 LINE (in accordance with DIN 1597)								
Width b in mm	Designation	Clamping ranges		l ₁ in mm	l ₂ in mm	Bore hole in mm d	Mat. thickness in mm s	W1 Product No.
		in mm	in inches					
16	BS 541 1 x 7	7	1/4"	44	28	5.5	1.5	0541 7000 007
	BS 541 1 x 9	9	3/8"	48	32	5.5	1.5	0541 7000 009
20	BS 541 1 x 13	13	1/2"	52	36	5.5	1.5	0541 7000 013
	BS 541 1 x 15.5	15.5	5/8"	56	40	5.5	1.5	0541 7000 015
	BS 541 1 x 19	19	3/4"	60	44	5.5	1.5	0541 7000 019
25	BS 541 1 x 23	23	15/16"	76	56	6.6	2	0541 7000 023
	BS 541 1 x 26	26	1"	78	58	6.6	2	0541 7000 026
	BS 541 1 x 28.5	28.5	1 1/8"	84	64	6.6	2	0541 7000 028
	BS 541 1 x 31	31	1 1/4"	84	64	6.6	2	0541 7000 031
30	BS 541 1 x 33	33	1 5/16"	92	72	6.6	2	0541 7000 033
	BS 541 1 x 36	36	1 7/16"	104	80	9	3	0541 7000 036
	BS 541 1 x 39	39	1 9/16"	108	84	9	3	0541 7000 039
	BS 541 1 x 43	43	1 11/16"	112	88	9	3	0541 7000 043
40	BS 541 1 x 46	46	1 13/16"	114	90	9	3	0541 7000 046
	BS 541 1 x 49	49	1 15/16"	118	90	11	3	0541 7000 049
	BS 541 1 x 52	52	2 1/16"	134	106	11	3	0541 7000 052
	BS 541 1 x 58	58	2 1/4"	138	110	11	3	0541 7000 058
	BS 541 1 x 61	61	2 3/8"	138	110	11	3	0541 7000 061

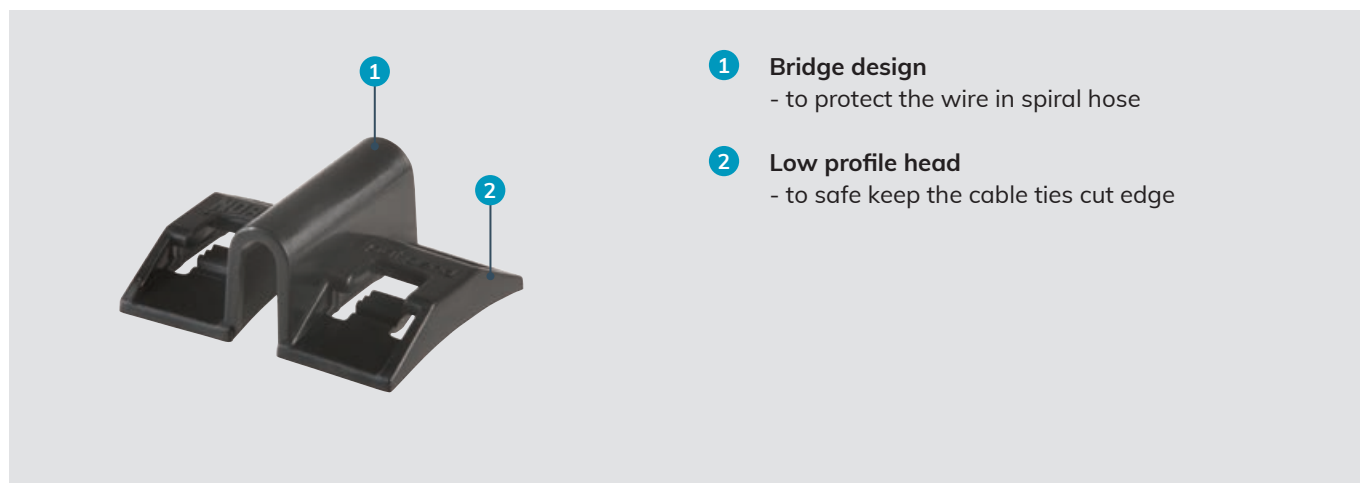

- 1 Bridge design**
- to protect the wire in spiral hose
- 2 Low profile head**
- to safe keep the cable ties cut edge

NORMAFIX® HVAC Clip – a flexible solution for fixing spiral hoses

In combination with our cable tie, the NORMAFIX® HVAC Clip makes it very easy to attach externally corrugated spiral hoses in HVAC (heating, ventilation, air conditioning) installations. It is a lightweight, flexible and economical alternative to metal spiral hose clamps. The patented shape and functionality of the NORMAFIX® HVAC Clip makes it possible to span the crossing of the hose spiral. Thanks to this special geometry, the cable tie can grip the hose around its whole perimeter so that it is fixed safely. Suitable for cable ties with bandwidth 9 mm. The shape of our HVAC Clip and our cable ties match perfectly, forming a reliable system. This system works independently of the direction of the spiral on the hose. The HVAC Clip can be used for both clockwise and counter clockwise spiral hoses. One clip fits all.

Advantages at a glance

- ✓ Economical, lightweight and flexible alternative to spiral hose clamps
- ✓ Applicable for both clockwise and counter clockwise spiral hoses
- ✓ Simple installation by hand, no special tools required

Did you know?

We have the right cable ties for you:
simply check pages 122 to 125.

Applications

- For any HVAC applications with spiral hoses
- Heating, ventilation, air conditioning
- Ventilation of greenhouses
- Clean room ventilation
- Welding fume exhaust

Technical data & Ordering information

NORMAFIX® HVAC CLIP	
Description	Product No.
HVAC CLIP	0859 2066 001

Material

Polyamide 6.6





TUBE CLAMP FITTINGS

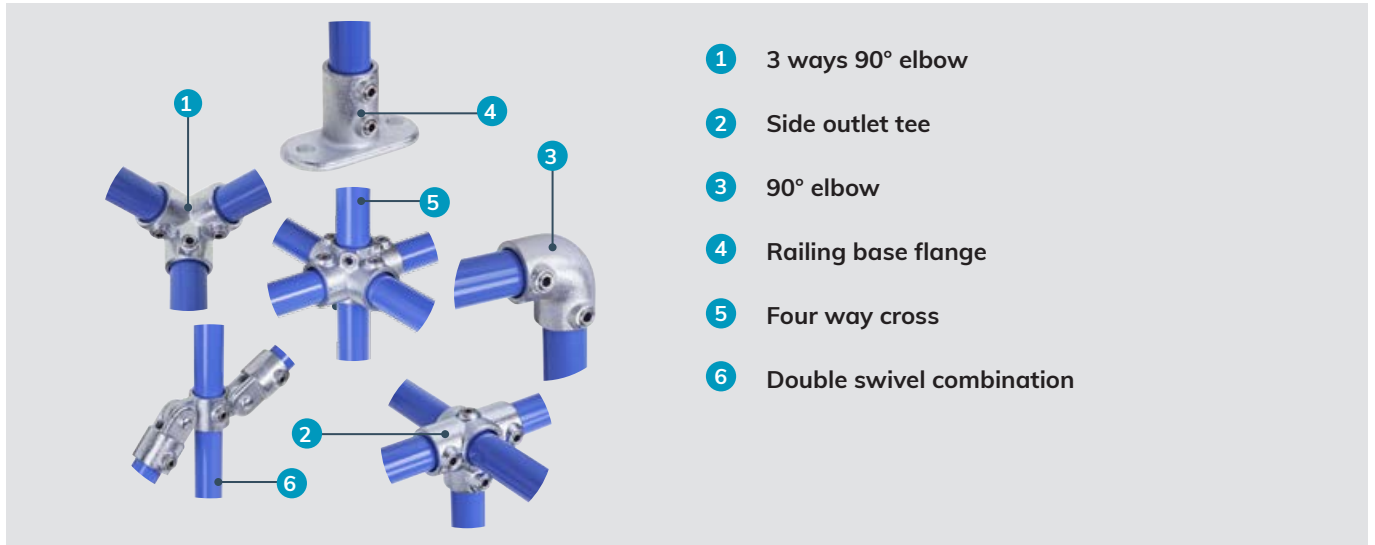

Tube clamp fittings for safety systems

Made of malleable galvanized iron to ensure strength, quality and conformity of production. NORMAFIX® Tube Clamp Fittings can be easily assembled on pipes in order to create safety systems.

Advantages at a glance

- ✓ Stainless steel screw
- ✓ Warranty up to 1500 N/m load
- ✓ No welding, so no fire permits required
- ✓ No threading, no bolting
- ✓ Can be assembled with a simple hexagonal key
- ✓ A versatile system that allows changes on site
- ✓ Can be painted

Applications

- Handrails
- Safety rails/Protective barriers
- Fall protections
- Other applications for safety work
- Fix railings
- Machinery guard
- Playgrounds

Material

Malleable galvanized iron

Sleeve joint



NORMAFIX® SLEEVE JOINT			
Designation	Diameter in mm	a mm	Malleable galvanized iron Product No.
SLEEVE JOINT 26.9	26.9	76	0819 6301 027
SLEEVE JOINT 33.7	33.7	90	0819 6301 034
SLEEVE JOINT 42.4	42.4	100	0819 6301 042
SLEEVE JOINT 48.3	48.3	100	0819 6301 048
SLEEVE JOINT 60.3	60.3	120	0819 6301 060

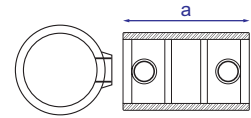

Refer to page 195 and 196

Expanding connector



NORMAFIX® EXPANDING CONNECTOR				
Designation	Diameter in mm	a mm	b mm	Malleable galvanized iron Product No.
EXPANDING CONNECTOR 33.7	33.7	78	20	0819 6302 034
EXPANDING CONNECTOR 42.4	42.4	78	20	0819 6302 042
EXPANDING CONNECTOR 48.3	48.3	78	20	0819 6302 048

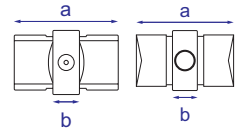

Refer to page 195 and 196

90° elbow



NORMAFIX® 90° ELBOW			
Designation	Diameter in mm	a mm	Malleable galvanized iron Product No.
90° ELBOW 26.9	26.9	41	0819 6303 027
90° ELBOW 33.7	33.7	46	0819 6303 034
90° ELBOW 42.4	42.4	60	0819 6303 042
90° ELBOW 48.3	48.3	68	0819 6303 048
90° ELBOW 60.3	60.3	84	0819 6303 060

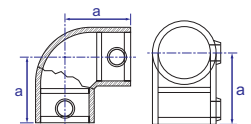

Refer to page 195 and 196

TUBE CLAMP FITTINGS

Short T



NORMAFIX® SHORT T			
Designation	Diameter in mm	a mm	Malleable galvanized iron Product No.
SHORT T 26.9	26.9	41	0819 6304 027
SHORT T 33.7	33.7	46	0819 6304 034
SHORT T 42.4	42.4	60	0819 6304 042
SHORT T 48.3	48.3	68	0819 6304 048
SHORT T 60.3	60.3	84	0819 6304 060

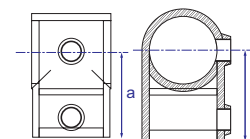

Refer to page 195 and 196

Long T



NORMAFIX® LONG T				
Designation	Diameter in mm	a mm	b mm	Malleable galvanized iron Product No.
LONG T 26.9	26.9	41	82	0819 6305 027
LONG T 33.7	33.7	46	92	0819 6305 034
LONG T 42.4	42.4	60	120	0819 6305 042
LONG T 48.3	48.3	68	135	0819 6305 048
LONG T 60.3	60.3	84	168	0819 6305 060

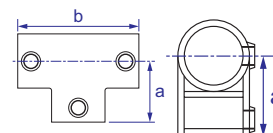

Refer to page 195 and 196

Wall flange



NORMAFIX® WALL FLANGE					
Designation	Diameter in mm	b mm	c mm	d mm	Malleable galvanized iron Product No.
WALL FLANGE 26.9	26.9	42	83	59	0819 6306 027
WALL FLANGE 33.7	33.7	48	89	65	0819 6306 034
WALL FLANGE 42.4	42.4	51	102	76	0819 6306 042
WALL FLANGE 48.3	48.3	59	114	88.5	0819 6306 048
WALL FLANGE 60.3	60.3	64	128	97	0819 6306 060

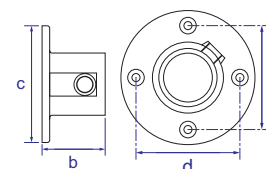

Refer to page 195 and 196

Railing base flange



NORMAFIX® RAILING BASE FLANGE						
Designation	Diameter in mm	a mm	c mm	d mm	e mm	Malleable galvanized iron Product No.
RAILING BASE FLANGE 26.9	26.9	60	105	76	52	0819 6307 027
RAILING BASE FLANGE 33.7	33.7	71	127	89	62	0819 6307 034
RAILING BASE FLANGE 42.4	42.4	84	139	101	72	0819 6307 042
RAILING BASE FLANGE 48.3	48.3	89	152	114	86	0819 6307 048
RAILING BASE FLANGE 60.3	60.3	104	165	127	96	0819 6307 060

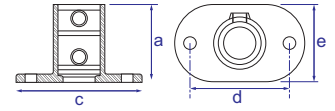

Refer to page 195 and 196

Handrail bracket



NORMAFIX® HANDRAIL BRACKET							
Designation	Diameter in mm	a mm	b mm	c mm	d mm	e mm	Malleable galvanized iron Product No.
HANDRAIL BRACKET 26.9	26.9	54	77	57	44	7	0819 6308 027
HANDRAIL BRACKET 33.7	33.7	57	80	62	44	7	0819 6308 034
HANDRAIL BRACKET 42.4	42.4	62	102	82.5	45	7	0819 6308 042
HANDRAIL BRACKET 48.3	48.3	70	107	82.5	50	7	0819 6308 048

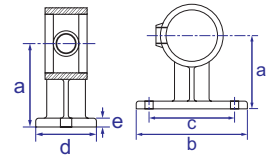

Refer to page 195 and 196

3 ways 90° elbow



NORMAFIX® 3 WAYS 90° ELBOW			
Designation	Diameter in mm	a mm	Malleable galvanized iron Product No.
3 WAYS 90° ELBOW 26.9	26.9	41	0819 6309 027
3 WAYS 90° ELBOW 33.7	33.7	48	0819 6309 034
3 WAYS 90° ELBOW 42.4	42.4	60	0819 6309 042
3 WAYS 90° ELBOW 48.3	48.3	68	0819 6309 048
3 WAYS 90° ELBOW 60.3	60.3	84	0819 6309 060

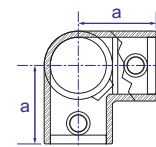

Refer to page 195 and 196



TUBE CLAMP FITTINGS

Corner C/W through tube



NORMAFIX® CORNER C/W THROUGH TUBE			
Designation	Diameter in mm	a mm	Malleable galvanized iron Product No.
CORNER C/W THRO TUBE 26.9	26.9	41	0819 6310 027
CORNER C/W THRO TUBE 33.7	33.7	46	0819 6310 034
CORNER C/W THRO TUBE 42.4	42.4	60	0819 6310 042
CORNER C/W THRO TUBE 48.3	48.3	68	0819 6310 048
CORNER C/W THRO TUBE 60.3	60.3	84	0819 6310 060

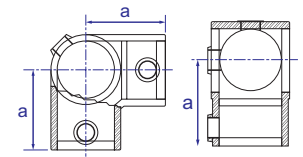

Refer to page 195 and 196

Two socket cross



NORMAFIX® TWO SOCKET CROSS			
Designation	Diameter in mm	a mm	Malleable galvanized iron Product No.
TWO SOCKET CROSS 26.9	26.9	82	0819 6311 027
TWO SOCKET CROSS 33.7	33.7	92	0819 6311 034
TWO SOCKET CROSS 42.4	42.4	120	0819 6311 042
TWO SOCKET CROSS 48.3	48.3	135	0819 6311 048
TWO SOCKET CROSS 60.3	60.3	168	0819 6311 060

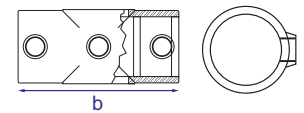

Refer to page 195 and 196

Side outlet tee



NORMAFIX® SIDE OUTLET TEE				
Designation	Diameter in mm	a mm	b mm	Malleable galvanized iron Product No.
SIDE OUTLET TEE 26.9	26.9	41	82	0819 6312 027
SIDE OUTLET TEE 33.7	33.7	46	92	0819 6312 034
SIDE OUTLET TEE 42.4	42.4	60	120	0819 6312 042
SIDE OUTLET TEE 48.3	48.3	68	136	0819 6312 048
SIDE OUTLET TEE 60.3	60.3	84.5	169	0819 6312 060

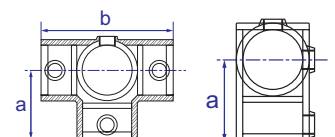

Refer to page 195 and 196

Four way cross and center



NORMAFIX® FOUR WAY CROSS AND CENTER			
Designation	Diameter in mm	a mm	Malleable galvanized iron Product No.
FOUR WAY CROSS AND CENTER 26.9	26.9	41	0819 6313 027
FOUR WAY CROSS AND CENTER 33.7	33.7	46	0819 6313 034
FOUR WAY CROSS AND CENTER 42.4	42.4	60	0819 6313 044
FOUR WAY CROSS AND CENTER 48.3	48.3	68	0819 6313 048

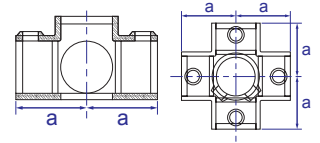

Refer to page 195 and 196

Fixing pad



NORMAFIX® FIXING PAD				
Designation	Diameter in mm	a mm	b mm	Malleable galvanized iron Product No.
FIXING PAD 33.7	33.7	60	43	0819 6314 034
FIXING PAD 42.4	42.4	66	48	0819 6314 042
FIXING PAD 48.3	48.3	70	52	0819 6314 048

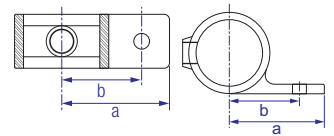

Refer to page 195 and 196

Double wall coupler



NORMAFIX® DOUBLE WALL COUPLER				
Designation	Diameter in mm	a mm	b mm	Malleable galvanized iron Product No.
DOUBLE WALL COUPLER 33.7	33.7	86	120	0819 6315 034
DOUBLE WALL COUPLER 42.4	42.4	95	130	0819 6315 042
DOUBLE WALL COUPLER 48.3	48.3	104	140	0819 6315 048

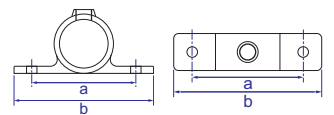

Refer to page 195 and 196

TUBE CLAMP FITTINGS

Male swivel



NORMAFIX® MALE SWIVEL			
Designation	Diameter in mm	b mm	Malleable galvanized iron Product No.
MALE SWIVEL 33.7	33.7	43.5	0819 6316 034
MALE SWIVEL 42.4	42.4	48	0819 6316 042
MALE SWIVEL 48.3	48.3	53	0819 6316 048
MALE SWIVEL 60.3	60.3	60	0819 6316 060

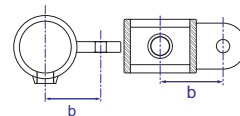

Refer to page 195 and 196

Female swivel



NORMAFIX® FEMALE SWIVEL				
Designation	Diameter in mm	a mm	b mm	Malleable galvanized iron Product No.
FEMALE SWIVEL 33.7	33.7	61	38	0819 6317 034
FEMALE SWIVEL 42.4	42.4	69	46	0819 6317 042
FEMALE SWIVEL 48.3	48.3	77	55	0819 6317 048
FEMALE SWIVEL 60.3	60.3	89	65	0819 6317 060

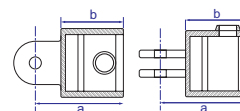

Refer to page 195 and 196

Gate eye



NORMAFIX® GATE EYE				
Designation	Diameter in mm	a mm	b mm	Malleable galvanized iron Product No.
GATE EYE 33.7	33.7	33	25.5	0819 6318 034
GATE EYE 42.4	42.4	38	25	0819 6318 042
GATE EYE 48.3	48.3	41	25	0819 6318 048

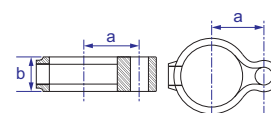

Refer to page 195 and 196

Gate hinge



NORMAFIX® GATE HINGE						
Designation	Diameter in mm	a mm	b mm	c mm	d mm	Malleable galvanized iron Product No.
GATE HINGE 33.7	33.7	33	25.5	38	12	0819 6319 034
GATE HINGE 42.4	42.4	38	25	38	12	0819 6319 042
GATE HINGE 48.3	48.3	25	25	38	12	0819 6319 048

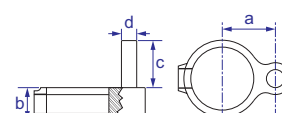

Refer to page 195 and 196

Double male swivel



NORMAFIX® DOUBLE MALE SWIVEL			
Designation	Diameter in mm	b mm	Malleable galvanized iron Product No.
DOUBLE MALE SWIVEL 33.7	33.7	84	0819 6320 034
DOUBLE MALE SWIVEL 42.4	42.4	95	0819 6320 042
DOUBLE MALE SWIVEL 48.3	48.3	105	0819 6320 048
DOUBLE MALE SWIVEL 60.3	60.3	124	0819 6320 060

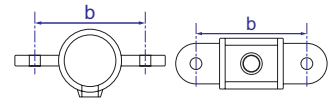

Refer to page 195 and 196

90° corner male swivel



NORMAFIX® 90° CORNER MALE SWIVEL			
Designation	Diameter in mm	a mm	Malleable galvanized iron Product No.
90° CORNER MALE SWIVEL 33.7	33.7	43.5	0819 6321 034
90° CORNER MALE SWIVEL 42.4	42.4	48	0819 6321 042
90° CORNER MALE SWIVEL 48.3	48.3	53	0819 6321 048
90° CORNER MALE SWIVEL 60.3	60.3	62	0819 6321 060

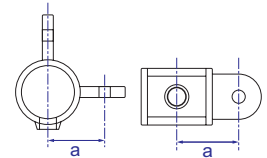

Refer to page 195 and 196

90° crossover



NORMAFIX® 90° CROSSOVER				
Designation	Diameter in mm	a mm	b mm	Malleable galvanized iron Product No.
90° CROSSOVER 26.9	26.9	31.5	38	0819 6322 027
90° CROSSOVER 33.7	33.7	38.5	41	0819 6322 034
90° CROSSOVER 42.4	42.4	46	49.5	0819 6322 042
90° CROSSOVER 48.3	48.3	51	55	0819 6322 048
90° CROSSOVER 60.3	60.3	61	67	0819 6322 060

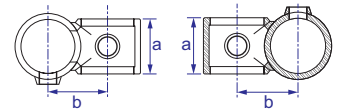

Refer to page 195 and 196

TUBE CLAMP FITTINGS

Single swivel combination



NORMAFIX® SINGLE SWIVEL COMBINATION				
Designation	Diameter in mm	a mm	b mm	Malleable galvanized iron Product No.
SINGLE SWIVEL COMBINATION 26.9	26.9	61	106	0819 6323 027
SINGLE SWIVEL COMBINATION 33.7	33.7	61	104.5	0819 6323 034
SINGLE SWIVEL COMBINATION 42.4	42.4	69	117	0819 6323 042
SINGLE SWIVEL COMBINATION 48.3	48.3	77	130	0819 6323 048
SINGLE SWIVEL COMBINATION 60.3	60.3	89	152	0819 6323 060

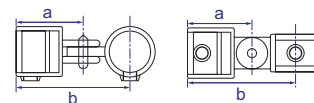

Refer to page 195 and 196

Base swivel combination



NORMAFIX® BASE SWIVEL COMBINATION							
Designation	Diameter in mm	a mm	b mm	c mm	d mm	e mm	Malleable galvanized iron Product No.
BASE SWIVEL COMBINATION 33.7	33.7	61	112	85	93	52	0819 6324 034
BASE SWIVEL COMBINATION 42.4	42.4	69	112	85	98	52	0819 6324 042
BASE SWIVEL COMBINATION 48.3	48.3	77	112	85	109	52	0819 6324 048
BASE SWIVEL COMBINATION 60.3	60.3	89	112	85	121	152	0819 6324 060

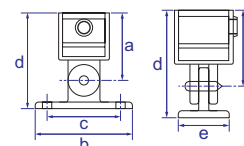

Refer to page 195 and 196

Double swivel combination



NORMAFIX® DOUBLE SWIVEL COMBINATION			
Designation	Diameter in mm	b mm	Malleable galvanized iron Product No.
DOUBLE SWIVEL COMBINATION 33.7	33.7	208	0819 6325 034
DOUBLE SWIVEL COMBINATION 42.4	42.4	228	0819 6325 042
DOUBLE SWIVEL COMBINATION 48.3	48.3	259	0819 6325 048

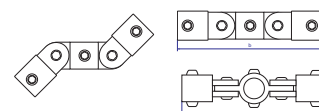

Refer to page 195 and 196

90° corner swivel combination



NORMAFIX® 90° CORNER SWIVEL COMBINATION			
Designation	Diameter in mm	a mm	Malleable galvanized iron Product No.
90° CORNER SWIVEL COMBINATION 33.7	33.7	104.5	0819 6326 034
90° CORNER SWIVEL COMBINATION 42.4	42.4	117	0819 6326 042
90° CORNER SWIVEL COMBINATION 48.3	48.3	130	0819 6326 048

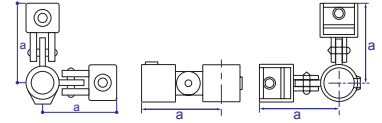

Refer to page 195 and 196

Short tee swivel



NORMAFIX® SHORT TEE SWIVEL			
Designation	Diameter in mm	a mm	Malleable galvanized iron Product No.
SHORT TEE SWIVEL 26.9	26.9	53	0819 6327 027
SHORT TEE SWIVEL 33.7	33.7	59	0819 6327 034
SHORT TEE SWIVEL 42.4	42.4	73	0819 6327 042
SHORT TEE SWIVEL 48.3	48.3	93	0819 6327 048

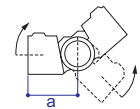

Refer to page 195 and 196

Clamp on tee



NORMAFIX® CLAMP ON TEE			
Designation	Diameter in mm	a mm	Malleable galvanized iron Product No.
CLAMP ON TEE 33.7	33.7	52.5	0819 6328 034
CLAMP ON TEE 42.4	42.4	67	0819 6328 042
CLAMP ON TEE 48.3	48.3	76.5	0819 6327 048

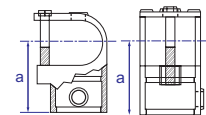

Refer to page 195 and 196

Fence building clamp



NORMAFIX® FENCE BUILDING CLAMP		
Designation	Diameter in mm	Electrolytic yellow passivated Product No.
FENCE BUILDING CLAMP	48	0819 6333 048

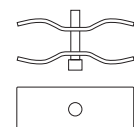

Refer to page 195 and 196

NORMAFIX®

ALU BAND CLAMP

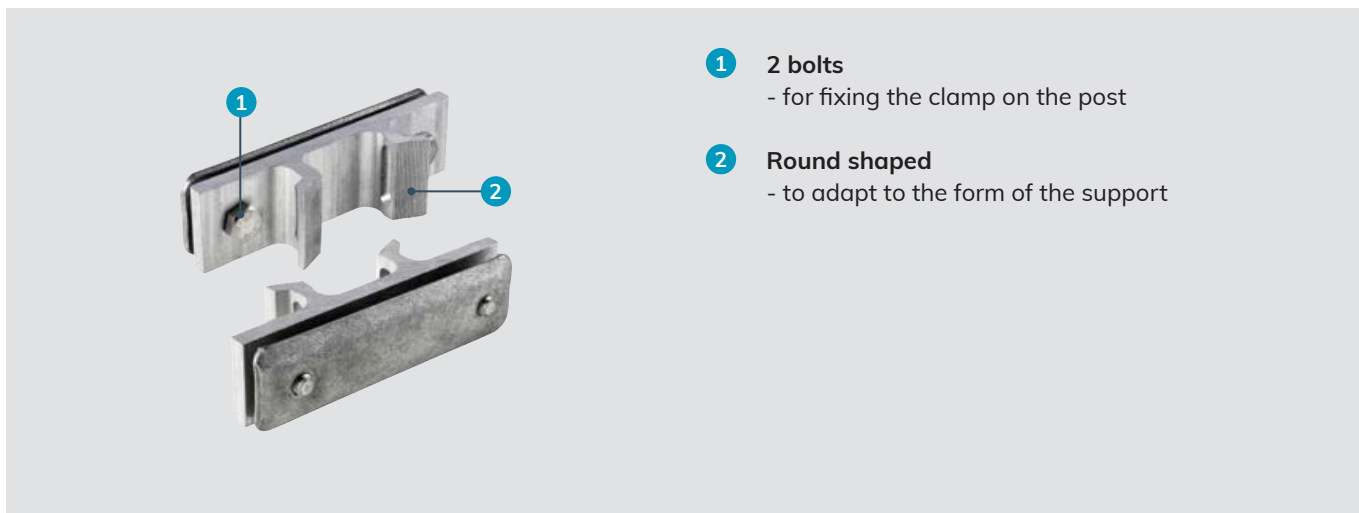

- 1 2 bolts
- for fixing the clamp on the post
- 2 Round shaped
- to adapt to the form of the support

Universal traffic sign fixation

Mainly used to hold road signs on a diversity of metal posts or lamppost diameters.



NORMAFIX®

Information

- Includes 2 bolts
- To be used with a worm drive hose clamp

Material

Aluminum

Applications

Traffic signs industry

Technical data & Ordering information

NORMAFIX® ALU BAND CLAMP			
Designation	Length in mm	Number of bolts	Aluminum Product No.
ALU BAND CLAMP	82	2	0560 7563 082
ALU BAND CLAMP	120	2	0560 7563 120

Did you know?

We have the right hose clamp for you: Hi-Torque Clamp, simply check page 26.

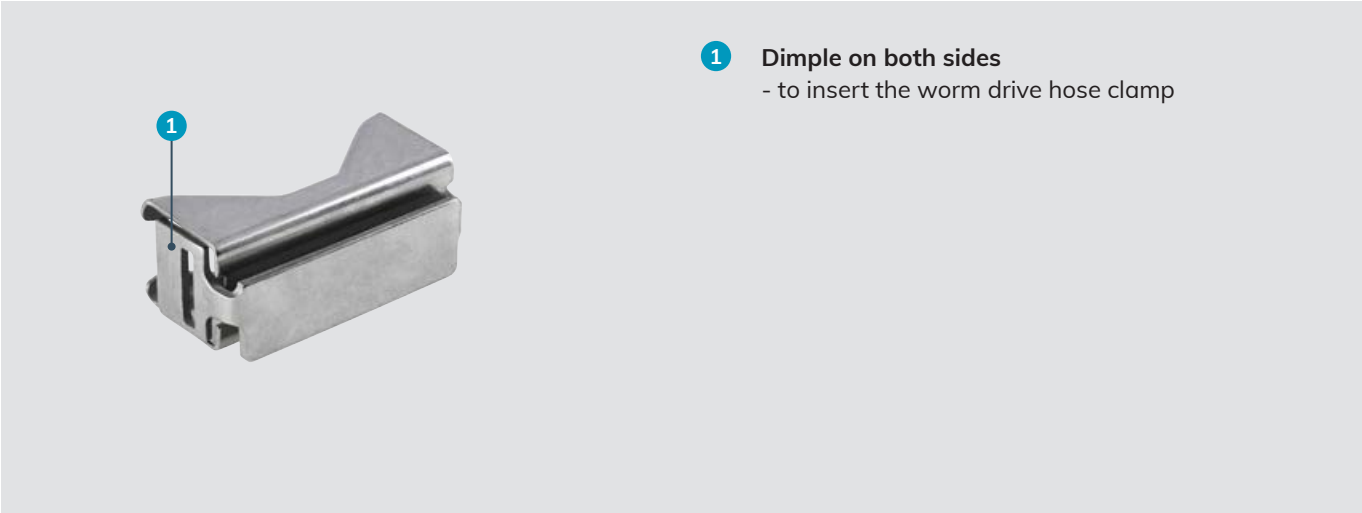

- 1 Dimple on both sides
- to insert the worm drive hose clamp

Universal traffic sign fixation

Mainly used to hold road signs on a diversity of metal posts or lamppost diameters.



Information

- To be used with a worm drive hose clamp

Applications

Traffic signs industry

Materials

Stainless steel

Technical data & Ordering information

NORMAFIX® UNIVERSAL UCC CLAMP	
Designation	Stainless steel Product No.
UNIVERSAL UCC CLAMP	0560 7620 000

Did you know?
We have the right hose clamp for you: Hi-Torque product, simply check page 26.



NORMAPLAST® – Hose Connectors

For a helping hand in industrial, commercial and private applications

NORMAPLAST® plastic hose connectors – the NORMA® range of products for rapidly connecting hoses and pipes – are the helping hands that no one working in industrial, commercial or private applications should be without.



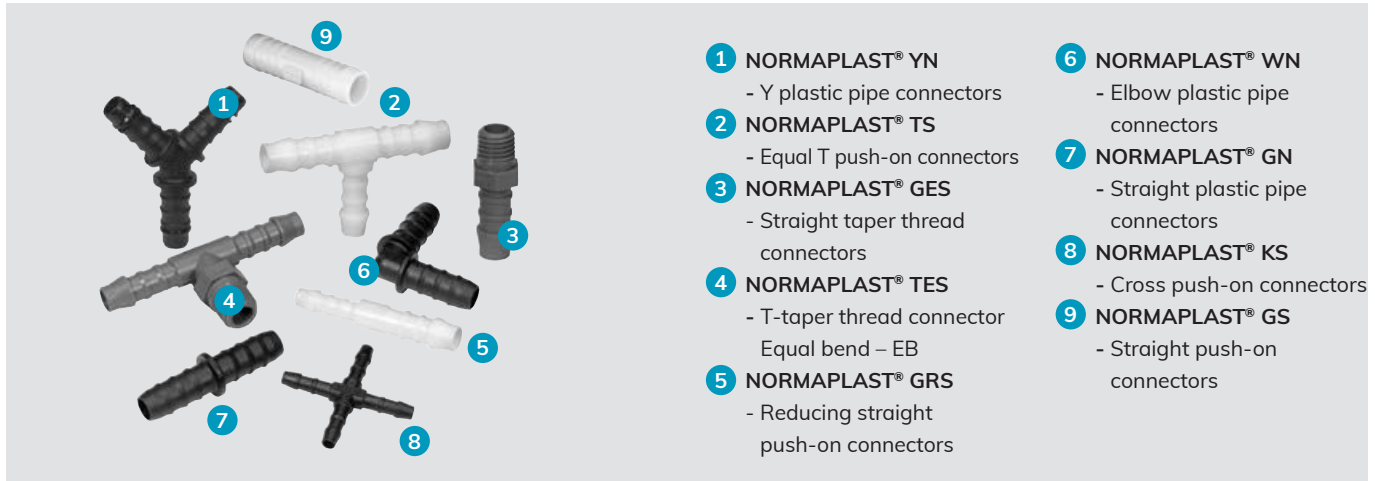

- 1** NORMAPLAST® YN
- Y plastic pipe connectors
- 2** NORMAPLAST® TS
- Equal T push-on connectors
- 3** NORMAPLAST® GES
- Straight taper thread connectors
- 4** NORMAPLAST® TES
- T-taper thread connector
Equal bend – EB
- 5** NORMAPLAST® GRS
- Reducing straight push-on connectors
- 6** NORMAPLAST® WN
- Elbow plastic pipe connectors
- 7** NORMAPLAST® GN
- Straight plastic pipe connectors
- 8** NORMAPLAST® KS
- Cross push-on connectors
- 9** NORMAPLAST® GS
- Straight push-on connectors

Hose connectors

NORMAPLAST® SV products are proven plastic hose and pipe connection components that create secure, reliable and affordable connections in lines used for transporting media. NORMAPLAST® SV hose and pipe connectors are used in the automotive construction industry as well as practically every other industrial sector. They are manufactured according to automotive standards and are NOT suitable for medical applications.

Advantages at a glance

- ✓ Extremely strong
- ✓ Durable
- ✓ Low weight
- ✓ Can be used for damping/absorption
- ✓ Resistant to abrasion
- ✓ Highly resistant to impact

Applications

- Machine building
- White goods
- Chemical industry
- Irrigation systems
- Food and beverage industry
- Railway industry
- Agricultural machines
- Building machines
- Engine manufacturing
- Pump and filter

Did you know?

We also offer products for medical applications with our brand CONNECTORS. You can find more information on the following website:

www.normagroup.com/connectors

Materials

Materials				
Mechanical Properties	PP Moplen HP501H	POM Polyacetal copolymer standard material hose connectors	PA6 Polyamide unreinforced standard material threaded connectors	PA with glass fiber Polyamide reinforced standard material pipe connectors
Operation temperature	0°C to +80°C short term (up to 1h) max. +100°C	-40°C to 80°C, short-term (up to 1h) 110°C	-40°C to 90°C, short-term (up to 1h) 120°C	-40°C to 120°C, short-term (up to 1h) 150°C
Max. admissible pressure	10bar	10bar	10bar	10bar

Applications	Recommended material range
Food area / drinking water area / chemical area	>POM<
Chemical area	>PP<
Chemical area (with aggressive media)	>PVDF<
Fuel / UREA (AdBlue) crank case ventilation	>PA12-GF30<
Cooling water / Windshield washer fluid	>PA6.6-GF30<
Air (Vaccum brake, Secondary air) TOC (Oil cooler, transmission oil)	>PA6-GF30<

Thermal properties

In the case of threaded spigots, the expansion coefficient 100×10^{-6} for thermoplastic material must be taken into consideration if temperature fluctuations occur. Our standard materials are classified in accordance with the UL (Underwriters Laboratories) system as follows:

- Flammability rating (UL94)
- POM, PP, PA6, PA6.6, and PA12: HB (Horizontal Burning)

Materials

Chemical properties of the plastics used								
No.	Chemical substance	Concentration	Temperature	POM	PP	PA 6	PA 6.6	PA 12
1	Acetone	100%	20 °C/50 °C	1/3	1/1	1/0	1/0	1/0
2	Formic acid	98-100%	20 °C/50 °C	4/4	1/3	4/4	4/4	4/4
3	Ammonium hydroxide (spirits of ammonia)	Any	20 °C/50 °C	1/2	1/1	1/0	1/0	1/0
4	Benzine; normal and super unleaded	Commercial	20 °C/50 °C	1/1	3/4	1/1	1/1	1/1
5	Benzene, benzene hydrocarbons	100%	20 °C/50 °C	3/3	3/4	1/0	1/0	1/0
6	Bleaching lye (12.5% active chlorine)	Aqueous solution 12.5%	20 °C/50 °C	4/4	3/3	4/4	4/4	3/3
7	Brake fluid (DOT4)	Commercial	20 °C/50 °C	1/1	1/1	1/1	1/1	1/1
8	Butanol	Technically pure	20 °C/50 °C	1/2	1/1	1/0	1/0	1/0
9	Chlorine, chlorine water	Commercial	20 °C/50 °C	4/4	4/4	4/4	4/4	4/4
10	Disinfectant phenols	Diluted solution	20 °C/50 °C	4/4	1/1	4/4	4/4	4/4
11	Diesel fuel, diesel oil	Commercial	20 °C/50 °C	1/1	1/3	1/1	1/1	1/1
12	Decalcifier	Aqueous solution~10%	20 °C/50 °C	4/4	1/1	2/3	2/3	2/3
13	Photographic developer (1:100)	Commercial	20 °C/50 °C	1/1	1/1	4/4	4/4	4/4
14	Natural gas (town gas, coal gas)	Commercial	20 °C/50 °C	1/1	1/1	1/1	1/1	1/1
15	Crude oil	Commercial	20 °C/50 °C	1/1	3/3	1/1	1/1	1/1
16	Acetic acid (glacial acetic acid)	90%	20 °C/50 °C	4/4	1/2	4/4	4/4	4/4
17	Ethyl alcohol	96% ((tech. pure)	20 °C/50 °C	1/2	1/1	1/0	1/0	1/0
18	Photographic emulsion	Commercial	20 °C/50 °C	1/0	1/1	1/0	1/0	1/0
19	Fruit juices	Commercial	20 °C/50 °C	1/1	1/1	1/1	1/1	1/1
20	Glycerine	Technically pure	20 °C/50 °C	1/1	1/1	1/1	1/1	1/1
21	Glystantin	Commercial	20 °C/50 °C	1/1	1/1	3/3	3/3	3/3
22	Heating oil	Commercial	20 °C/50 °C	1/1	1/3	1/1	1/1	1/1
23	Hydraulic fluid	Commercial	20 °C/50 °C	1/0	1/3	1/1	1/1	1/1
24	Carbon dioxide, carbonic acid	Technically pure, saturated	20 °C/50 °C	1/1	1/1	1/0	1/0	1/0
25	Coolants (based on glycol)	Commercial	20 °C/50 °C	1/1	1/1	3/3	1/1	1/1
26	Methane	Technically pure	20 °C/50 °C	1/1	1/1	1/1	1/1	1/1
27	Methanol	Technically pure	20 °C/50 °C	1/1	1/1	1/1	1/1	3/3
28	Methyl ethyl ketone	100%	20 °C/50 °C	3/3	1/3	1/0	1/0	1/1
29	Engine oils (HD)	Commercial	20 °C/50 °C	1/1	1/3	1/1	1/1	1/1
30	Sodium hydroxide (lye; caustic soda)	40%	20 °C/50 °C	1/1	1/1	1/1	1/1	1/1
31	Ozone	Gaseous	20 °C/50 °C	4/4	3/4	3/4	3/4	3/4
32	Propanol	Technically pure	20 °C/50 °C	1/1	1/1	1/1	1/1	2/2
33	Propane (liquefied gas)	Liquid	20 °C/50 °C	1/1	1/1	1/0	1/0	1/0
34	Propene	96%	20 °C/50 °C	1/0	1/1	1/0	1/0	1/0
35	Rape oil (rape oil methyl ester)	Commercial	20 °C/50 °C	1/1	2/2 (*)	1/1	1/1	1/1
36	Hydrochloric acid	Aqueous, 10%	20 °C/50 °C	4/4	1/1	4/4	4/4	3/3
37	Lubricating oil/grease, soft soap	Commercial	20 °C/50 °C	1/1	1/2	1/1	1/1	1/1
38	Sulphuric acid	Aqueous, 10%	20 °C/50 °C	4/4	1/2	3/3	3/3	2/2
39	De-icing salt solution (brine)	Saturated	20 °C/50 °C	1/2	1/1	1/1	1/1	1/1
40	Soap suds (dissolved detergent)	Diluted solution	20 °C/50 °C	1/1	2/2 (*)	1/1	1/1	1/1
41	Water (drinking, river, sea)	Technically pure	20 °C/50 °C	1/1	1/1	1/1	1/1	1/1
42	Citric acid	10%	20 °C/50 °C	2/4	1/1	1/0	1/0	1/0

Explanation of abbreviations:

POM = Acetal copolymer

PP = Polypropylene

PA = Polyamide

0 = No data available/Not possible to make an appropriate statement

1 = Highly stable/suitable (change in dimensions: none or negligible and reversible; no damage even after extended period)

2 = Very stable/suitable (change in dimensions after short period: none or negligible and reversible; little change in dimensions, possibly irreversible change to properties after extended period)

3 = Limited stability (considerable changes to dimensions, possibly irreversible change to properties after extended period)

4 = Unstable/unsuitable (soluble or serious effects after a short period)

(*) Moisture expansion

The specifications in this catalogue are based on tests carried out by the granular material manufacturer. They are intended to serve as guidelines for our customers, but cannot simply be applied to any case in which customers expose these products to demands which fall outside the scope of the tests performed. On no account should this be done without first consulting us.

Our customers must perform their own tests to determine whether our NORMAPLAST® plastic hose connecting components are suitable for the application they are intended to be used in. We will be happy to offer any advice or information required.

Our liability is subject exclusively to our terms of delivery and sale. Special versions can be produced if an appropriate quantity of the component in question is ordered.

Please contact the relevant manufacturer before using a product as a safety component.



Use as a hose connector

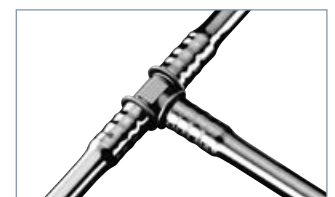

Use as a push-on connector

GES – Straight taper thread connectors

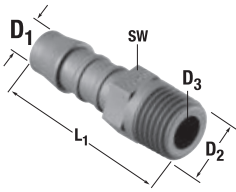

GES – STRAIGHT TAPER THREAD CONNECTORS							
Nominal size ID hose (in mm)	Designation	D ₁	D ₂	D ₃	L ₁ ~	SW	Material PA6 Product No.
3	GES 3 / M 5	3	M 5 cyl	2.5	19.5	6	0710 8952 003
4	GES 4 / M 8 x 1	4	M 8 x 1 con.	2.5	27	10	0710 8901 004
	GES 4 / M 8 x 1.25	4	M 8 x 1.25 con.	2.5	27	10	0710 8902 004
	GES 4 / M 10 x 1	4	M 10 x 1 con.	2.5	27	10	0710 8903 004
	GES 4 / M 12 x 1.5	4	M 12 x 1.5 con.	2.5	32	14	0710 8904 004
	GES 4 / M 14 x 1.5	4	M 14 x 1.5 con.	2.5	32	14	0710 8905 004
	GES 4 / R 1/8	4	R 1/8 con.	2.5	27	10	0710 8910 004
	GES 4 / R 1/4	4	R 1/4 con.	2.5	32	14	0710 8911 004
	GES 4 / 1/8 NPT	4	1/8 NPT	2.5	29	10	0710 8917 004
	GES 4 / 1/4 NPT	4	1/4 NPT	2.5	35	14	0710 8918 004
5	GES 5 / M 12 x 1.5	5	M 12 x 1.5 con.	3	36	14	0710 8904 005
	GES 5 / M 14 x 1.5	5	M 14 x 1.5 con.	3	36	14	0710 8905 005
	GES 5 / R 1/4	5	R 1/4 con.	3	36	14	0710 8911 005
	GES 5 / R 1/4 NPT	5	R 1/4 NPT	3	39	14	0710 8918 005
6	GES 6 / M 10 x 1	6	M 10 x 1 con.	4	32.5	10	0710 8903 006
	GES 6 / M 12 x 1.5	6	M 12 x 1.5 con.	4	37.5	14	0710 8904 006
	GES 6 / M 14 x 1.5	6	M 14 x 1.5 con.	4	36.5	14	0710 8905 006
	GES 6 / R 1/8	6	R 1/8 con.	4	32.5	10	0710 8910 006
	GES 6 / R 1/4	6	R 1/4 con.	4	37.5	14	0710 8911 006
	GES 6 / R 3/8	6	R 3/8 con.	4	39	17	0710 8912 006
	GES 6 / 1/8 NPT	6	1/8 NPT	4	34.5	10	0710 8917 006
	GES 6 / 1/4 NPT	6	1/4 NPT	4	40.5	14	0710 8918 006
8	GES 8 / M 10 x 1	8	M 10 x 1 con.	5.6	38	14	0710 8903 008
	GES 8 / M 12 x 1.5	8	M 12 x 1.5 con.	5.6	41	14	0710 8904 008
	GES 8 / M 14 x 1.5	8	M 14 x 1.5 con.	5.6	41	14	0710 8905 008
	GES 8 / M 18 x 1.5	8	M 18 x 1.5 con.	5.6	49	22	0710 8907 008
	GES 8 / M 22 x 1.5	8	M 22 x 1.5 con.	5.6	49	22	0710 8949 008
	GES 8 / M 26 x 1.5	8	M 26 x 1.5 con.	5.6	58	27	0710 8908 008
	GES 8 / R 1/8	8	R 1/8 con.	5.6	38	14	0710 8910 008
	GES 8 / R 1/4	8	R 1/4 con.	5.6	41	14	0710 8911 008
	GES 8 / R 3/8	8	R 3/8 con.	5.6	41	17	0710 8912 008
	GES 8 / R 1/2	8	R 1/2 con.	5.6	49	22	0710 8913 008
	GES 8 / 1/4 NPT	8	1/4 NPT	5.6	44	14	0710 8918 008
10	GES 10 / M 12 x 1.5	10	M 12 x 1.5 con.	7	43.5	14	0710 8904 010
	GES 10 / M 14 x 1.5	10	M 14 x 1.5 con.	7	43.5	14	0710 8905 010
	GES 10 / M 16 x 1.5	10	M 16 x 1.5 con.	7	43.5	17	0710 8906 010
	GES 10 / R 1/4	10	R 1/4 con.	7	43.5	14	0710 8911 010
	GES 10 / R 3/8	10	R 3/8 con.	7	43.5	17	0710 8912 010
	GES 10 / 1/4 NPT	10	1/4 NPT	7	46.5	14	0710 8918 010
	GES 10 / 3/8 NPT	10	3/8 NPT	7	46.5	17	0710 8919 010
12	GES 12 / M 16 x 1.5	12	M 16 x 1.5 con.	8.6	45.5	17	0710 8906 012
	GES 12 / M 18 x 1.5	12	M 18 x 1.5 con.	8.6	54	22	0710 8907 012
	GES 12 / M 22 x 1.5	12	M 22 x 1.5 con.	8.6	54	22	0710 8949 012
	GES 12 / M 26 x 1.5	12	M 26 x 1.5 con.	8.6	58	27	0710 8909 012
	GES 12 / R 3/8	12	R 3/8 con.	8.6	45.5	17	0710 8912 012
	GES 12 / R 1/2	12	R 1/2 con.	8.6	54	22	0710 8913 012
14	GES 14 / M 20 x 1.5	14	M 20 x 1.5 con.	10	56	22	0710 8908 014
	GES 14 / R 3/8	14	R 3/8 con.	10	56	17	0710 8912 014
	GES 14 / R 1/2	14	R 1/2 con.	10	56	22	0710 8913 014
	GES 14 / R 1/2 NPT	14	R 1/2 NPT	10	58	22	0710 8920 014
16	GES 16 / M 26 x 1.5	16	M 26 x 1.5 con.	12	58	27	0710 8909 016
	GES 16 / R 1/2	16	R 1/2 con.	12	58	22	0710 8913 016
	GES 16 / R 3/4	16	R 3/4 con.	12	58	27	0710 8914 016
19	GES 19 / M 26 x 1.5	19	M 26 x 1.5 con.	15	58	27	0710 8909 019
	GES 19 / R 3/4	19	R 3/4 con.	15	58	27	0710 8914 019
25	GES 25 / R 1	25	R 1 con.	21	69	32	0710 8915 025

BST – Blanking plugs with screw-in thread

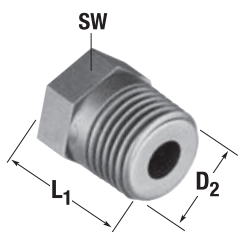

BST – BLANKING PLUGS WITH SCREW-IN THREAD				
Designation	D ₂	L ₁ ~	SW	Material PA6 Product No.
BST M 8 x 1	M 8 x 1 con.	13	10	0711 8901 000
BST M 10 x 1	M 10 x 1 con.	13.5	10	0711 8903 000
BST M 12 x 1.5	M 12 x 1.5 con.	17.5	14	0711 8904 000
BST M 14 x 1.5	M 14 x 1.5 con.	17.5	14	0711 8905 000
BST M 18 x 1.5	M 18 x 1.5 con.	26.5	22	0711 8907 000
BST M 20 x 1.5	M 20 x 1.5 con.	25	22	0711 8908 000
BST M 26 x 1.5	M 26 x 1.5 con.	26.5	22	0711 8909 000
BST R 1/8	R 1/8 con.	26	22	0711 8910 000
BST R 1/4	R 1/4 con.	12.5	10	0711 8911 000
BST R 3/8	R 3/8 con.	17.5	14	0711 8912 000
BST R 1/2	R 1/2 con.	27	17	0711 8913 000
BST 1/8 NPT	1/8 NPT	27.5	22	0711 8917 000
BST 1/4 NPT	1/4 NPT	14	10	0711 8918 000
BST M 22 x 1.5	M 22 x 1.5 con.	20.5	14	0711 8949 000

TES – T-taper thread connectors

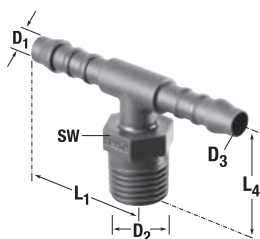

TES – T-TAPER THREAD CONNECTORS								
Nominal size ID hose (in mm)	Designation	D ₁	D ₂	D ₃	L ₁ ~	L ₄ ~	SW	Material PA6 Product No.
4	TES 4 / M 8 x 1	4	M 8 x 1 con.	2.5	21	18	10	0720 8901 004
	TES 4 / M 10 x 1	4	M 10 x 1 con.	2.5	21	18	10	0720 8903 004
	TES 4 / M 12 x 1.5	4	M 12 x 1.5 con.	2.9	21	23	14	0720 8904 004
	TES 4 / R 1/8	4	R 1/8 con.	2.5	21	18	10	0720 8910 004
	TES 4 / R 1/4	4	R 1/4 con.	2.5	21	23	14	0720 8911 004
	TES 4 / 1/8 NPT	4	1/8 NPT	2.5	21	20	10	0720 8917 004
	TES 4 / 1/4 NPT	4	1/4 NPT	2.5	21	26	14	0720 8918 004
6	TES 6 / M 10 x 1	6	M 10 x 1 con.	4	28.5	21	10	0720 8903 006
	TES 6 / M 12 x 1.5	6	M 12 x 1.5 con.	4	28.5	26	14	0720 8904 006
	TES 6 / R 1/8	6	R 1/8 con.	4	28.5	21	10	0720 8910 006
	TES 6 / R 1/4	6	R 1/4 con.	4	28.5	26	14	0720 8911 006
	TES 6 / 1/8 NPT	6	1/8 NPT	4	28.5	23	10	0720 8917 006
	TES 6 / 1/4 NPT	6	1/4 NPT	4	28.5	29	14	0720 8918 006
8	TES 8 / M 12 x 1.5	8	M 12 x 1.5 con.	5.6	33	27.5	14	0720 8904 008
	TES 8 / M 14 x 1.5	8	M 14 x 1.5 con.	5.6	33	27.5	14	0720 8905 008
	TES 8 / R 1/4	8	R 1/4 con.	5.6	33	27.5	14	0720 8911 008
	TES 8 / 1/4NPT	8	1/4NPT	5.6	33	30.5	14	0720 8918 008
10	TES 10 / R 3/8	10	R 3/8 con.	7	35.5	30	17	0720 8912 010

NORMAPLAST®

WES – Elbow taper thread connectors

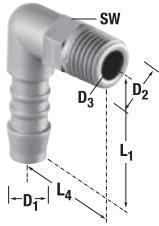

WES – ELBOW TAPER THREAD CONNECTORS								
Nominal size ID hose (in mm)	Designation	D ₁	D ₂	D ₃	L ₁ ~	L ₄ ~	SW	Material PA6 Product No.
3	WES 3 / M 5 cyl.	3	M 5 cyl.	2.5	12.5	12.5	6	0730 8952 003
4	WES 4 / M 8 x 1	4	M 8 x 1 con.	2.7	21	16	10	0730 8901 004
	WES 4 / M 10 x 1	4	M 10 x 1 con.	2.7	21	16	10	0730 8903 004
	WES 4 / M 12 x 1.5	4	M 12 x 1.5 con.	2.7	21	25	14	0730 8904 004
	WES 4 / M 14 x 1.5	4	M 14 x 1.5 con.	2.7	21	25	14	0730 8905 004
	WES 4 / R 1/8	4	R 1/8 con.	2.7	21	16	10	0730 8910 004
	WES 4 / R 1/4	4	R 1/4 con.	2.7	21	25	14	0730 8911 004
	WES 4 / 1/8 NPT	4	1/8 NPT	2.7	21	18	10	0730 8917 004
	WES 4 / 1/4 NPT	4	1/4 NPT	2.7	21	28	14	0730 8918 004
6	WES 6 / M 10 x 1	6	M 10 x 1 con.	4	28.5	21	10	0730 8903 006
	WES 6 / M 12 x 1.5	6	M 12 x 1.5 con.	4	28.5	26	14	0730 8904 006
	WES 6 / R 1/8	6	R 1/8 con.	4	28.5	21	10	0730 8910 006
	WES 6 / R 1/4	6	R 1/4 con.	4	28.5	26	14	0730 8911 006
	WES 6 / R 3/8	6	R 3/8 con.	4	28.5	27	17	0730 8912 006
	WES 6 / 1/8 NPT	6	1/8 NPT	4	28.5	23	10	0730 8917 006
	WES 6 / 1/4 NPT	6	1/4 NPT	4	28.5	29	14	0730 8918 006
8	WES 8 / M 10 x 1	8	M 10 x 1 con.	5.6	33	23.5	14	0730 8903 008
	WES 8 / M 12 x 1.5	8	M 12 x 1.5 con.	5.6	33	27.5	14	0730 8904 008
	WES 8 / M 14 x 1.5	8	M 14 x 1.5 con.	5.6	33	27.5	14	0730 8905 008
	WES 8 / M 16 x 1.5	8	M 16 x 1.5 con.	5.6	36	27.5	17	0730 8906 008
	WES 8 / M 18 x 1.5	8	M 18 x 1.5 con.	5.6	36	36	19	0730 8907 008
	WES 8 / M 22 x 1.5	8	M 22 x 1.5 con.	5.6	36	36	22	0730 8949 008
	WES 8 / R 1/8	8	R 1/8 con.	5.6	33	23	14	0730 8910 008
	WES 8 / R 1/4	8	R 1/4 con.	5.6	33	27.5	14	0730 8911 008
	WES 8 / R 3/8	8	R 3/8 con.	5.6	36	31	17	0730 8912 008
	WES 8 / R 1/2	8	R 1/2 con.	5.6	36	36	22	0730 8913 008
WES 8 / 1/4 NPT	8	1/4 NPT	5.6	33	30.5	14	0730 8918 008	
10	WES 10 / M 14 x 1.5	10	M 14 x 1.5 con.	7	38	30	14	0730 8905 010
	WES 10 / R 1/4	10	R 1/4	7	38	30	14	0730 8911 010
	WES 10 / R 3/8	10	R 3/8	7	38	30	17	0730 8912 010
	WES 10 / 1/2 NPT	10	1/2 NPT	7	38	38	22	0730 8920 010
12	WES 12 / M 16 x 1.5	12	M 16 x 1.5 con.	8.6	40.5	30	17	0730 8906 012
	WES 12 / M 18 x 1.5	12	M 18 x 1.5 con.	8.6	40.5	36	19	0730 8907 012
	WES 12 / M 22 x 1.5	12	M 22 x 1.5 con.	8.6	40.5	36	22	0730 8949 012
	WES 12 / M 26 x 1.5	12	M 26 x 1.5 con.	8.6	40.5	36	22	0730 8909 012
	WES 12 / R 3/8	12	R 3/8	8.6	40.5	31	17	0730 8912 012
	WES 12 / R 1/2	12	R 1/2	8.6	40.5	36	22	0730 8913 012
	WES 12 / 3/8 NPT	12	3/8 NPT	8.6	40.5	31	19	0730 8919 012
19	WES 19 / M 24 x 2	19	M 24 x 2 con.	15	45	42.8	27	0730 8953 019
	WES 19 / R 3/4	19	R 3/4 con.	15	45.5	42.8	27	0730 8914 019
25	WES 25 / R 1	25	R 1 con.	21	60	49	32	0730 8915 025

GS – Straight push-on connectors

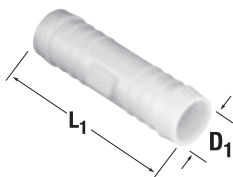

GS – STRAIGHT PUSH-ON CONNECTORS					
Nominal size ID hose (in mm)	Designation	D ₁	D ₂	L ₁ ~	Material POM Product No.
3	GS 3	3	2.5	25	0750 8900 003
4	GS 4	4	2.7	35	0750 8900 004
5	GS 5	5	3	45	0750 8900 005
6	GS 6	6	4	49	0750 8900 006
8	GS 8	8	5.6	56	0750 8900 008
10	GS 10	10	7	63	0750 8900 010
12	GS 12	12	8.6	66.5	0750 8900 012
13	GS 13	13	8.6	73	0750 8900 013
14	GS 14	14	10	79	0750 8900 014
16	GS 16	16	12	75	0750 8900 016
19	GS 19	19	15	76	0750 8900 019
25	GS 25	25	21	95	0750 8900 025

Additional materials available on request



Refer to page 188 and 189

GRS – Reducing straight push-on connectors

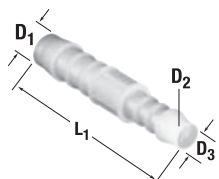

GRS – REDUCING STRAIGHT PUSH-ON CONNECTORS						
Nominal size ID hose (in mm)	Designation	D ₁	D ₂	D ₃	L ₁ ~	Material POM Product No.
4 - 3	GRS 4 - 3	4	2.5	3	30	0751 8904 003
5 - 4	GRS 5 - 4	5	2.7	3	41	0751 8905 004
6 - 4	GRS 6 - 4	6	2.7	4	42.5	0751 8906 004
8 - 4	GRS 8 - 4	8	2.7	4	48	0751 8908 004
8 - 6	GRS 8 - 6	8	4	6	54	0751 8908 006
10 - 6	GRS 10 - 6	10	4	6	58	0751 8910 006
10 - 8	GRS 10 - 8	10	5.6	8	60.5	0751 8910 008
12 - 8	GRS 12 - 8	12	5.6	8	62.5	0751 8912 008
12 - 10	GRS 12 - 10	12	7	10	64	0751 8912 010

Additional materials available on request



Refer to page 189

TS – Equal T push-on connectors

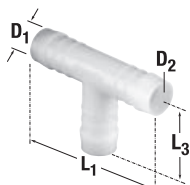

TS – EQUAL T PUSH-ON CONNECTORS						
Nominal size ID hose (in mm)	Designation	D ₁	D ₂	L ₁ ~	L ₃ ~	Material POM Product No.
3	TS 3	3	2.5	25	12.5	0760 8900 003
4	TS 4	4	2.7	35	19.5	0760 8900 004
5	TS 5	5	3	42	22	0760 8900 005
6	TS 6	6	4	50	26	0760 8900 006
7	TS 7	7	5	50	26	0760 8900 007
8	TS 8	8	5.6	58	30	0760 8900 008
10	TS 10	10	7	62.5	33.5	0760 8900 010
12	TS 12	12	8.6	69	36	0760 8900 012
13	TS 13	13	8.6	68	36	0760 8900 013
14	TS 14	14	10	77.5	41.5	0760 8900 014
15	TS 15	15	11	79.5	43.5	0760 8900 015
16	TS 16	16	12	81	45	0760 8900 016
19	TS 19	19	15	85	45	0760 8900 019
25	TS 25	25	21	105	52.5	0760 8900 025

Additional materials available on request



Refer to page 188 and 189

KS – Cross push-on connectors

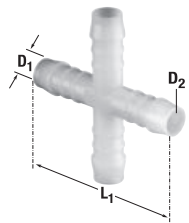

KS – CROSS PUSH-ON CONNECTORS					
Nominal size ID hose (in mm)	Designation	D ₁	D ₂	L ₁ ~	Material POM Product No.
4	KS 4	4	2.9	39	0772 8900 004
5	KS 5	5	3	48	0772 8900 005
6	KS 6	6	4	48	0772 8900 006
12	KS 12	12	8.6	69	0772 8900 012

Additional materials available on request

TRS – Reducing T push-on connectors

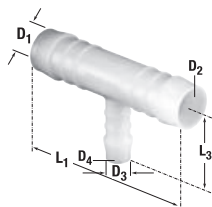

TRS – REDUCING T PUSH-ON CONNECTORS								
Nominal size ID hose (in mm)	Designation	D ₁	D ₂	D ₃	D ₄	L ₁ ~	L ₃ ~	Material POM Product No.
3 - 4 - 3	TRS 3 - 4 - 3	3	2.5	4	2.5	25	17.5	0761 8903 004
4 - 6 - 4	TRS 4 - 6 - 4	4	2.7	6	4	37	24	0761 8904 006
6 - 4 - 6	TRS 6 - 4 - 6	6	4	4	2.5	49	20.5	0761 8906 004
8 - 4 - 8	TRS 8 - 4 - 8	8	5.6	4	2.5	56	22	0761 8908 004
8 - 6 - 8	TRS 8 - 6 - 8	8	5.6	6	4	56	28	0761 8908 006
8 - 12 - 8	TRS 8 - 12 - 8	8	5.6	12	8.6	57	34	0761 8908 012
10 - 6 - 10	TRS 10 - 6 - 10	10	7	6	4	62	28	0761 8910 006
10 - 8 - 10	TRS 10 - 8 - 10	10	7	8	5.6	62	31	0761 8910 008
10 - 13 - 10	TRS 10 - 13 - 10	10	7	13	8.6	64	38	0761 8910 013
12 - 6 - 12	TRS 12 - 6 - 12	12	8.6	6	4	69	29	0761 8912 006
12 - 8 - 12	TRS 12 - 8 - 12	12	8.6	8	5.6	69	31	0761 8912 008
12 - 10 - 12	TRS 12 - 10 - 12	12	8.6	10	7	69	33	0761 8912 010
15 - 6 - 15	TRS 15 - 6 - 15	15	11	6	4	78	28	0761 8915 006
15 - 8 - 15	TRS 15 - 8 - 15	15	11	8	5.6	79	33	0761 8915 008
18 - 10 - 18	TRS 18 - 10 - 18	18	14	10	7	79	36	0761 8918 010
18 - 15 - 18	TRS 18 - 15 - 18	18	14	15	11	80	44	0761 8918 015

Additional materials available on request

YRS – Reducing Y push-on connectors

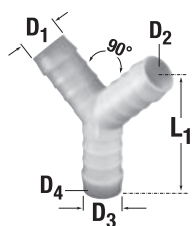

YRS – REDUCING Y PUSH-ON CONNECTORS							
Nominal size ID hose (in mm)	Designation	D ₁	D ₂	D ₃	D ₄	L ₁ ~	Material POM Product No.
4 - 6 - 4	YRS 4 - 6 - 4	4	2.7	6	4	35	0771 8904 006
6 - 8 - 6	YRS 6 - 8 - 6	6	4	8	5.6	49	0771 8906 008

Additional materials available on request

WS – Elbow push-on connectors

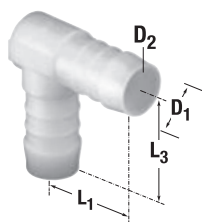

WS – ELBOW PUSH-ON CONNECTORS						
Nominal size ID hose (in mm)	Designation	D ₁	D ₂	L ₁ ~	L ₃ ~	Material POM Product No.
3	WS 3	3	2.5	12.5	12.5	0762 8900 003
4	WS 4	4	2.5	17.5	19.5	0762 8900 004
5	WS 5	5	3	21	22	0762 8900 005
6	WS 6	6	4	25	26	0762 8900 006
8	WS 8	8	5.6	29	30	0762 8900 008
10	WS 10	10	7	31	33.5	0762 8900 010
12	WS 12	12	8.6	34.5	36	0762 8900 012
13	WS 13	13	8.6	36.5	38.5	0762 8900 013
14	WS 14	14	10	38.5	41.5	0762 8900 014
15	WS 15	15	11	40	43.5	0762 8900 015
16	WS 16	16	12	40.5	45	0762 8900 016
19	WS 19	19	15	43.5	46	0762 8900 019
25	WS 25	25	21	52.5	52.5	0762 8900 025

Additional materials available on request

YS – Equal Y push-on connectors



YS – EQUAL Y PUSH-ON CONNECTORS					
Nominal size ID hose (in mm)	Designation	D ₁	D ₂	L ₁ ~	Material POM Product No.
3	YS 3	3	2.5	21	0770 8900 003
4	YS 4	4	2.5	25.5	0770 8900 004
5	YS 5	5	3	43	0770 8900 005
6	YS 6	6	4	44	0770 8900 006
8	YS 8	8	5.6	51	0770 8900 008
10	YS 10	10	7	54	0770 8900 010
12	YS 12	12	8.6	64	0770 8900 012
13	YS 13	13	9	65	0770 8900 013
14	YS 14	14	10	65	0770 8900 014
16	YS 16	16	12	67	0770 8900 016
19	YS 19	19	15	72	0770 8900 019

Additional materials available on request



Refer to page 189

NORMAPLAST®

GN – Straight plastic pipe connectors

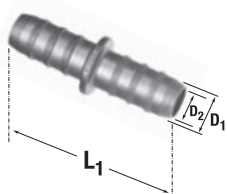

GN – STRAIGHT PLASTIC PIPE CONNECTORS							
Nominal size ID PA tube (in mm)	Designation	D ₁	D ₂	L ₁ ~	Material PA6 -GF30* Product No.	Material PA12-GF20* Product No.	Material PA12-GF30* Product No.
6	GN 6	6.4	4.75	45			0750 8200 006
8	GN 8	9.2	6.8	46	0750 8074 008		
10	GN 10	11	8	46	0750 8300 010		0750 8200 010
15	GN 15	16.9	12	32		0750 8001 015	
19	GN 19	21	16	39		0750 8001 019	
27	GN 27	29	24	42		0750 8001 027	
27 - 19	GRN 27 - 19	29 - 21	24 - 16	44		0751 8045 000	

* Glass fiber content

TN – T plastic pipe connectors

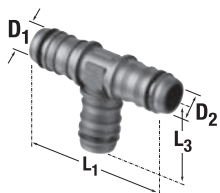

TN – T PLASTIC PIPE CONNECTORS								
Nominal size ID PA tube (in mm)	Designation	D ₁	D ₂	L ₁ ~	L ₃ ~	Material PA6 -GF30* Product No.	Material PA66-GF30* Product No.	Material PA12-GF30* Product No.
4	TN 4	4.6	2.5	43	23	0760 8129 004		
6	TN 6	6.4	4.75	56.5	28.5	0760 8202 006	0760 8203 006	0760 8200 006
8	TN 8	9.2	6.8	58	29	0760 8112 008		0760 8200 008
10	TN 10	11	8	60	30			0760 8200 010
15	TN 15	16.4	12	72	36			0760 8200 015
19	TN 19	18.9	16	65	32.5			0760 8201 019
15-8-15	TN 15-8-15	16.4-8.9-16.4	12-6-12	72	35			0761 8052 000
15-12-15	TN 15-12-15	16.4-13.5-16.4	12-10.5-12	72	35.5			0761 8015 012

* Glass fiber content

WN – Elbow plastic pipe connectors

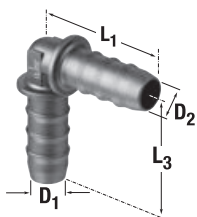

WN – ELBOW PLASTIC PIPE CONNECTORS								
Nominal size ID PA tube (in mm)	Designation	D ₁	D ₂	L ₁ ~	L ₃ ~	Material PA6 -GF30* Product No.	Material PA66-GF30* Product No.	Material PA12-GF30* Product No.
6	WN 6	6.4	4.75	28	28		0762 8205 006	0762 8200 006
8	WN 8	9.2	6.8	29	29	0762 8067 008		0762 8200 008
10	WN 10	11	8	30	30	0762 8201 010		0762 8200 010
19	WN 19	18.9	16	32	32			0762 8200 019

* Glass fiber content

YN – Y plastic pipe connectors



YN – Y PLASTIC PIPE CONNECTORS							
Nominal size ID PA tube (in mm)	Designation	D ₁	D ₂	L ₁ ~	Material PA66-GF30* Product No.	Material PA12-GF20* Product No.	Material PA12-GF30* Product No.
8	YN 8	8.4	5.8	50.5	0770 8203 008		0770 8200 008
10	YN 10	11	8	80			0770 8200 010
15	YN 15	14.9	12	49.3			0770 8200 015
19	YN 19	18.9	16	85		0770 8201 019	

* Glass fiber content

EG – Straight compression connectors



EG – STRAIGHT COMPRESSION CONNECTORS							
Nominal size ID PA tube (in mm)	Designation	D ₁	D ₂	L ₁ ~	SW	Diameter	Material PA12-GF30* Product No.
6	EG 6 x 1-R 1/8	6 x 1	R 1/8 con.	25	13	6 x 1-R 1/8	0780 8900 001
	EG 6 x 1-R 1/4	6 x 1	R 1/4 con.	31	17	6 x 1-R 1/4	0780 8900 002
	EG 6 x 1-M10 x 1	6 x 1	M10 x 1 con.	25	13	6 x 1-M10 x 1	0780 8900 003
8	EG 8 x 1-R 1/8	8 x 1	R 1/8 con.	25	13	8 x 1-R 1/8	0780 8900 021
	EG 8 x 1-R 1/4	8 x 1	R 1/4 con.	31	17	8 x 1-R 1/4	0780 8900 022
	EG 8 x 1-M10 x 1	8 x 1	M10 x 1 con.	25	13	8 x 1-M10 x 1	0780 8900 023

* Glass fiber content

EWS – Swivel elbow compression connectors



EWS – SWIVEL ELBOW COMPRESSION CONNECTORS								
Nominal size ID PA tube (in mm)	Designation	D ₁	D ₂	L ₁ ~	L ₂ ~	L ₃ ~	SW	Material PA6-GF30* Product No.
6	EWS 6 x 1-R 1/8	6 x 1	R 1/8	14	21	30	13	0780 8901 001
	EWS 6 x 1-R 1/4	6 x 1	R 1/4	15	23	33.5	17	0780 8901 002
	EWS 6 x 1-M10 x 1	6 x 1	M10 x 1	14	21	30	13	0780 8901 003
8	EWS 8 x 1-R 1/8	8 x 1	R 1/8	14	21	30	13	0780 8901 021
	EWS 8 x 1-R 1/4	8 x 1	R 1/4	15	23	33.5	17	0780 8901 022
	EWS 8 x 1-M10 x 1	8 x 1	M10 x 1	14	21	30	13	0780 8901 023

* Glass fiber content

ET – T compression connectors



ET – T COMPRESSION CONNECTORS						
Nominal size ID PA tube (in mm)	Designation	D ₁	D ₂	L ₁ ~	L ₂ ~	Material PA6-GF30* Product No.
6	ET 6 x 1-R 1/8	6 x 1	R 1/8 con.	19	23	0780 8904 001
	ET 6 x 1-R 1/4	6 x 1	R 1/4 con.	23	23	0780 8904 002
	ET 6 x 1-M10 x 1	6 x 1	M10 x 1 con.	19	23	0780 8904 003
8	ET 8 x 1-R 1/8	8 x 1	R 1/8 con.	19	23	0780 8904 021
	ET 8 x 1-R 1/4	8 x 1	R 1/4 con.	23	23	0780 8904 022
	ET 8 x 1-M10 x 1	8 x 1	M10 x 1 con.	19	23	0780 8904 023

* Glass fiber content

EW/WV – Elbow compression connectors



EW/WV – ELBOW COMPRESSION CONNECTORS						
Nominal size ID PA tube (in mm)	Designation	D ₁	D ₂	L ₁ ~	L ₂ ~	Material PA6-GF30* Product No.
6	EW 6 x 1 - R 1/8	6 x 1	R 1/8 con.	19	23	0780 8905 001
	EW 6 x 1 - R 1/4	6 x 1	R 1/4 con.	23	23	0780 8905 002
	EW 6 x 1 - M10 x 1	6 x 1	M10 x 1 con.	19	23	0780 8905 003
8	EW 8 x 1 - R 1/8	8 x 1	R 1/8 con.	19	23	0780 8905 021
	EW 8 x 1 - R 1/4	8 x 1	R 1/4 con.	23	23	0780 8905 022
	EW 8 x 1 - M10 x 1	8 x 1	M10 x 1 con.	19	23	0780 8905 023
	WV 8 x 1	8 x 1	8 x 1	23	23	0781 8900 011

* Glass fiber content

VT/VTR – Equal T and reducing T compression connectors



VT/VTR – EQUAL T AND REDUCING T COMPRESSION CONNECTORS						
Nominal size ID PA tube (in mm)	Designation	D ₁	D ₂	L ₁ ~	L ₂ ~	Material PA6-GF30* Product No.
6 and/or 8	VT 6 x 1	6 x 1	6 x 1	23	23	0781 8900 001
	VT 8 x 1	8 x 1	8 x 1	23	23	0781 8900 002
	VTR 6 x 1-8 x 1-6 x 1	6 x 1	8 x 1	23	23	0781 8900 021
	VTR 8 x 1-6 x 1-8 x 1	8 x 1	6 x 1	23	23	0781 8900 022

* Glass fiber content

VG/VGR – Straight/Reducing compression connectors



VG/VGR – STRAIGHT/REDUCING COMPRESSION CONNECTORS					
Nominal size ID PA tube (in mm)	Designation	D ₁	L ₁ ~	SW	Material PA6-GF30* Product No.
6 and/or 8	VG 6 x 1	6 x 1	31	17	0781 8901 003
	VG 8 x 1	8 x 1	31	17	0781 8901 002
	VGR 8 x 1 - 6 x 1	6 x 1	31	17	0781 8901 004

* Glass fiber content

NORMAQUICK® – Quick Connectors

Innovative, secure and quick fit plug-in connectors

NORMA Group's quick connector range offers state-of-the-art connections. They are made from synthetic material and can be used for most media-carrying lines. Excellent temperature and chemical resistance is combined with a lightweight and compact design to reduce assembly times.



Robust elements for fluid transport – NORMAQUICK®

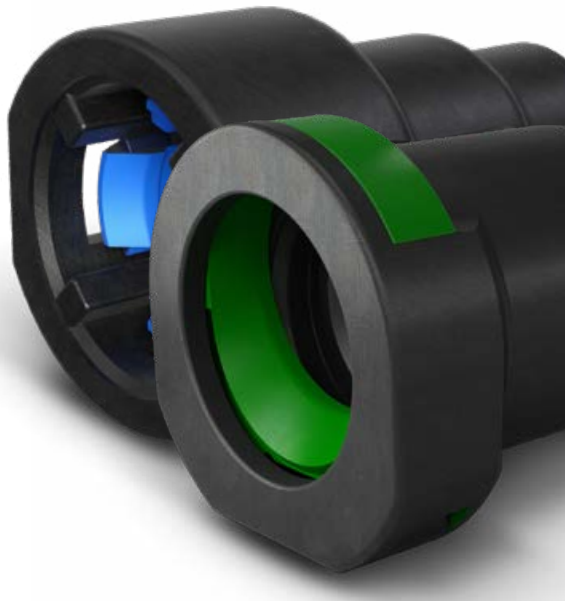

NORMA Group offers a wide selection of high-quality, robust quick connectors for use in fuel systems, oil systems and other lines that transport media. Their compact, lightweight design helps to cut costs and save weight in any application. They are also suitable for installation in very tight spaces. Our Quick Connectors are used in many industrial applications, e.g. on lubrication lines in industrial machinery.

Product benefits at a glance

- ✓ Leakproof connections
- ✓ Fast assembly
- ✓ Sturdy, compact design

Range and applications

NORMAQUICK® S Quick Connectors are attached to their counterparts (spigots) to connect a fluid system with a technical component. They transport air, fuel, oil, cooling water, battery fluid and other fluids. Each has a locking mechanism at the head made of metal or plastic to ensure safe fluid transport.



S
Highest safety performance according to SAE standard for use in the field of fuel.

NORMAQUICK® SR Single-Lock connectors have a chamfer design-based locking mechanism for reliable connection of fuel lines. Here the safety requirements are especially rigorous: fuel must never leak from the tank or engine of a vehicle. The chamfer feature in the connector locks the retainer under pressure ensuring 100% reliable connection.



SR Single-Lock
Simple and safe with single-lock mechanism for use in fuel and urea.

NORMAQUICK® PS3 “Push & Seal” plastic quick connectors are an ideal means for the secure connection of coolant and heater hoses as well as charged air systems.



PS3
“Push & Seal” connection for cooling water/heating pipes and charged air.

NORMAQUICK® V2 quick connectors are an ideal means to connect media carrying lines as well as ventilation and exhaust lines. The connectors can be used for both line-to-line and line-to-device connections. Our V2 can be applied on both plastic and metal spigots.



V2
Secure connection of media carrying lines, ventilation and exhaust lines.

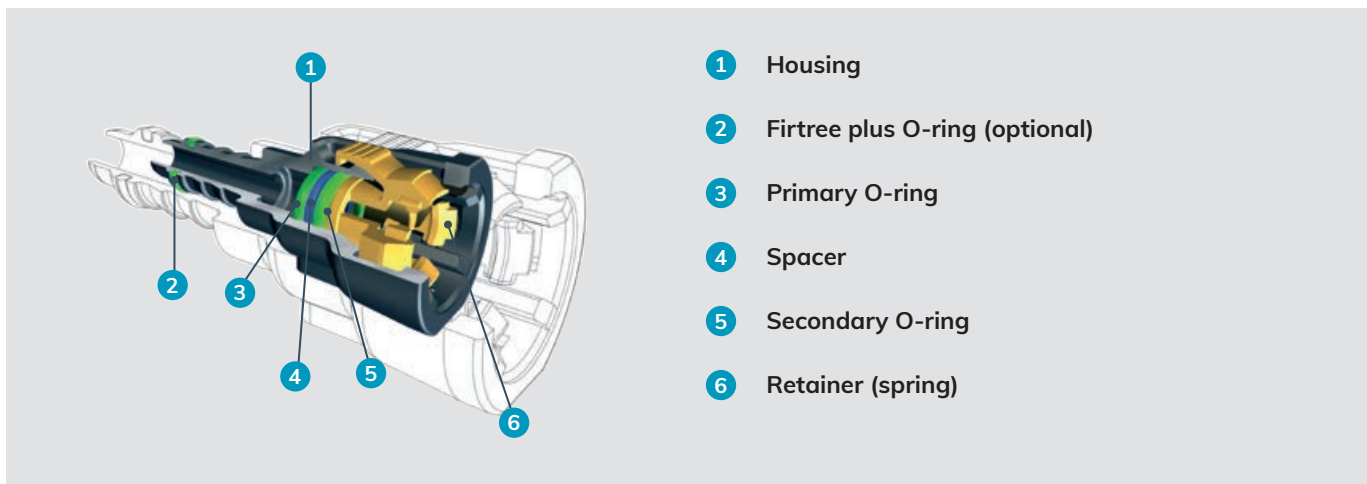

- 1 Housing
- 2 Firtree plus O-ring (optional)
- 3 Primary O-ring
- 4 Spacer
- 5 Secondary O-ring
- 6 Retainer (spring)

Efficient connection of fuel carrying lines

NORMAQUICK® S plastic quick connectors designed according to SAE standard are the ideal means for connecting media carrying lines in combustion engines. It has been especially developed for fuel system applications and is characterized by its “click” sound as well as its quick and safe connection.

Advantages at a glance

- ✓ Leak-proof connection due to sealing with two O-rings
- ✓ Cannot be opened under pressure due to two locking arms
- ✓ Offers audible indicator to ensure locking
- ✓ Compact design allows for assembly in narrow spaces
- ✓ No assembly tool required

Materials

Housing	PA12-GF50
Retainer	PA12-GF30
O-rings	Inside housing FPM & FVMQ; on fir tree FPM

Technical drawing

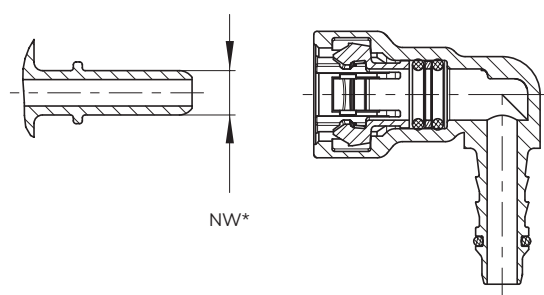

* NW (Nominal Width): Diameter of the connecting spigot

Applications

NORMAQUICK® S connectors are ideal means for connecting fuel lines. They are designed to connect worldwide standardized spigots as per SAEJ2044 guidelines.

Technical data & Ordering information

NORMAQUICK® S		
Designation	Ø Nominal width (mm or inch)	Product No.
NORMAQUICK® S NW 1/4" - 1/4" - 0°	1/4"	0715 6002 006
NORMAQUICK® S NW 1/4" - 1/4" - 90°	1/4"	0715 6001 006
NORMAQUICK® S NW 5/16" - 5/16" - 0°	5/16"	0715 6103 008
NORMAQUICK® S NW 5/16" - 5/16" - 90°	5/16"	0715 6555 008
NORMAQUICK® S NW 5/16" - 6 mm - 0°	5/16"	0715 6509 008
NORMAQUICK® S NW 5/16" - 6 mm - 90°	5/16"	0715 6511 008
NORMAQUICK® S NW 8 mm - 6 mm - 0°	8 mm	0715 6501 008
NORMAQUICK® S NW 8 mm - 6 mm - 90°	8 mm	0715 6502 008
NORMAQUICK® S NW 3/8" - 6 mm - 0°	3/8"	0715 6550 010
NORMAQUICK® S NW 3/8" - 6 mm - 90°	3/8"	0715 6510 010
NORMAQUICK® S NW 3/8" - 5/16" - 0°	3/8"	0715 6509 010
NORMAQUICK® S NW 3/8" - 5/16" - 90°	3/8"	0715 6519 010
NORMAQUICK® S NW 9.89 mm - 8 mm - 0°	9.89 mm	0715 6701 010
NORMAQUICK® S NW 9.89 mm - 8 mm - 90°	9.89 mm	0715 6702 010
NORMAQUICK® S NW 1/2" - 10 mm - 0°	1/2"	0715 6595 012
NORMAQUICK® S NW 1/2" - 10 mm - 90°	1/2"	0715 6596 012
NORMAQUICK® S NW 1/2" - 12 mm - 0°	1/2"	0715 6506 012
NORMAQUICK® S NW 1/2" - 12 mm - 90°	1/2"	0715 6507 012
NORMAQUICK® S NW 5/8" - 5/8" - 0°	5/8"	0715 6501 016
NORMAQUICK® S NW 5/8" - 5/8" - 90°	5/8"	0715 6502 016

NORMAQUICK®



- 1 Chamfer
- 2 O-ring
- 3 Housing

Connection of media-carrying lines in vehicles

NORMAQUICK® SR Single-Lock quick connectors are used mainly in the automotive fluid line applications. Designed according to SAE standard, they are known for their high quality and ease of assembly and disassembly process.

Advantages at a glance

- ✓ Chamfer feature locks the retainer under pressure, making the connection highly reliable
- ✓ Audible indicator (“click”) confirms locking of the adapter
- ✓ Compact design allows for assembly in narrow spaces
- ✓ Zero leakage
- ✓ No assembly tool required

Applications

NORMAQUICK® SR Single-Lock connectors are an ideal means of connecting fuel lines. They are designed to meet SAE J2044 standards. Ø 13 mm is used for crankcase ventilation systems.

Technical data & Ordering information

NORMAQUICK® SR Single-Lock		
Designation	Nominal width (mm)	Product No.
SR Single-Lock - Ø 7.89 mm - tube ID 6.00 mm - 0°	7.89	A614A50-06M04
SR Single-Lock - Ø 7.89 mm - tube ID 6.00 mm - 90°	7.89	A624E50-06M04
SR Single-Lock - Ø 8.00 mm - tube ID 6.00 mm - 0°	8.00	A610R08-06M02
SR Single-Lock - Ø 8.00 mm - tube ID 6.00 mm - 90°	8.00	A620N08-06M02
SR Single-Lock - Ø 9.49 mm - tube ID 8.00 mm - 0°	9.49	A613A53-08M02
SR Single-Lock - Ø 9.49 mm - tube ID 8.00 mm - 90°	9.49	A623C53-08M04
SR Single-Lock - Ø 9.89 mm - tube ID 8.00 mm - 0°	9.89	A614-52-08M01
SR Single-Lock - Ø 9.89 mm - tube ID 8.00 mm - 90°	9.89	A624-52-08M01
SR Single-Lock - Ø 10.00 mm - tube ID 8.00 mm - 0°	10.00	A610M10-08M02
SR Single-Lock - Ø 10.00 mm - tube ID 8.00 mm - 90°	10.00	A620N10-08M02
SR Single-Lock - Ø 13.00 mm - tube ID 8.00 mm - 0°	13.00	9615 13 10M05
SR Single-Lock - Ø 13.00 mm - tube ID 8.00 mm - 90°	13.00	9625 13 10M05

Materials

Housing	PA12-GF30 (Ø 7.89 mm to 10.00 mm) and PA66-GF30 (Ø 13.00 mm)
Retainer	PA12-GF30

Technical drawing

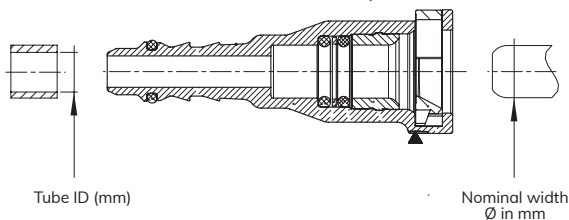

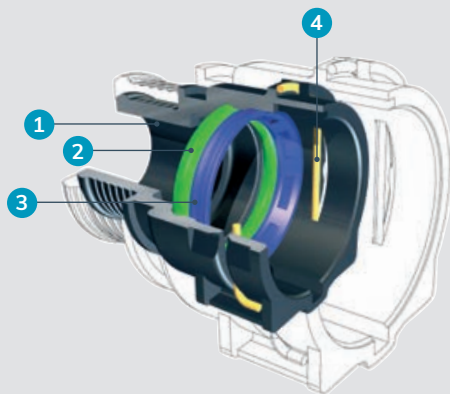

- 1 Housing
- 2 O-ring
- 3 Retaining ring
- 4 Retainer (spring)

Secure connection for cooling water and heating hoses

NORMAQUICK® PS3 “Push & Seal” plastic quick connectors are an ideal means for the secure connection of cooling water and heating hoses.

Advantages at a glance

- ✓ Time and cost reduction due to snap assembly without tool
- ✓ Application in extremely narrow spaces thanks to compact dimensions
- ✓ Optimal tightness through integrated seal
- ✓ Designed to be mounted on standard spigot design
- ✓ Resistance to coolant medium thanks to O-ring consisting of peroxide cured EPDM
- ✓ PA66 (GF30 housing and retainer) stabilized against heat and hydrolysis effect for direct contact with coolant
- ✓ Made from recyclable materials

Technical data & Ordering information

NORMAQUICK® PS3		
Designation	Nominal width (mm)	Product No.
NORMAQUICK® PS3 NW 06-0°	6.00	0702 8003 006
NORMAQUICK® PS3 NW 06-6-90°	6.00	0702 8008 006
NORMAQUICK® PS3 NW 08-0°	8.00	0702 7002 008
NORMAQUICK® PS3 NW 08-90°	8.00	0702 7703 008
NORMAQUICK® PS3 NW 12-0°	12.00	0702 6009 012
NORMAQUICK® PS3 NW 12-90°	12.00	0702 6008 012
NORMAQUICK® PS3 NW 16-0°	16.00	0702 7019 016
NORMAQUICK® PS3 NW 16-90°	16.00	0702 6020 016
NORMAQUICK® PS3 NW 20-0°	20.00	0702 7003 020
NORMAQUICK® PS3 NW 20-90°	20.00	0702 7004 020
NORMAQUICK® PS3 NW 26-0°	26.00	0702 6007 026
NORMAQUICK® PS3 NW 26-90	26.00	0702 7011 026
NORMAQUICK® PS3 NW 32-0°	32.00	0702 7018 032
NORMAQUICK® PS3 NW 32-90°	32.00	0702 7042 032

Materials

Housing	PA66-GF30
O-ring	EPDM (peroxide cured)
Fastening ring	PA66-GF30
Retainer (spring)	Stainless steel 1.4310 (DIN EN 10270-3)

Applications

NORMAQUICK® PS3 connectors are used for leak proof connection of cooling water lines or heating lines in passenger and commercial vehicles.

Technical drawing

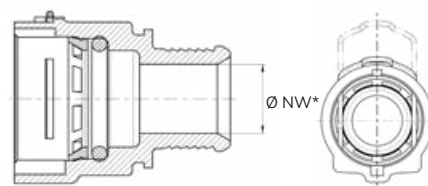

* Ø NW: Nominal Width



Quick assembly and compact design

NORMAQUICK® Single-Lock quick connectors are used mainly in the automotive fluid line applications. Designed according to SAE standard, they are known for their high quality and ease of assembly and disassembly process.

Advantages at a glance

- ✓ Quick assembly time equaling cost reduction
- ✓ Automated production, no human factor means less margin of error
- ✓ No tools needed
- ✓ Compact dimensions allowing ease of use in narrow spaces
- ✓ An integrated seal provides optimal tightness
- ✓ All seals can be visually checked, permitting safe assembly

Technical data & Ordering information

NORMAQUICK® V2					
Designation	Ø NW (mm)	Recommended applications	Primary O-ring	Secondary O-ring	Product No.
V2 NW 06-90°	6	VAC, AFS, SAS	FPM	HNBR	0713 7006 006
V2 NW 08-0°	8	VAC, AFS, SAS	FPM	FVMQ	0713 6029 008
V2 NW 08-90°	8	VAC, AFS, SAS	FPM	FVMQ	0713 6012 008
V2 NW 08-90°	8	VAC, AFS, SAS	FPM	HNBR	0713 7010 008
V2 NW 10-06-90°	10	VAC, AFS, SAS	FPM	-	0713 7095 010
V2 NW 10-10-90°	10	VAC, AFS, SAS	FPM	-	0713 7012 010
V2 NW 10-08-90°	10	VAC, AFS, SAS	FPM	-	0713 7034 010
V2 NW 10-10-0°	10	VAC, AFS, SAS	FPM	-	0713 6033 010
V2 NW 12-12-0°	12	CVS, OTS, AFS, SAS	FPM	-	0713 7030 012
V2 NW 12-12-0°	12	CVS, OTS, TVS, AFS, SAS	FPM	HNBR	0713 6038 012
V2 NW 15-15-0°	15	CVS, OTS, AFS, SAS	FPM	-	0713 6015 015
V2 NW 19-19-0°	19	CVS, OTS, AFS, SAS	FPM	-	0713 6005 019
V2 NW 19-19-90°	19	CVS, OTS, TVS, AFS, SAS	FPM	HNBR	0713 6005 019
V2 NW 27-27-0°	27	CVS, OTS, AFS, SAS	FPM	-	0713 4002 027
V2 NW 27-27-90°	27	CVS, OTS, AFS, SAS	FPM	-	0713 6169 027

Materials

Housing	Polyamide with reinforced glass fibre
O-ring	FPM / FVMQ / HNBR

Applications

- Air intake and induction
- Fuel and oil systems

Technical drawing

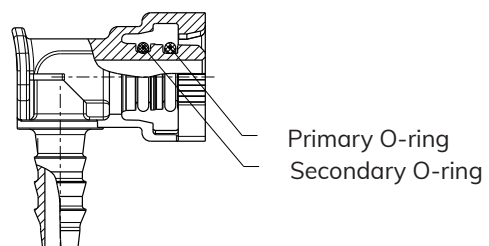

NORMAEXTRA® – Kits, Assortments, Displays, Tools and Accessories

A wide range of assortments, displays, dispensers and tools

NORMA assortments section offers the possibility of having several clamp diameters in one package. All the accessories and the tools mentioned in this chapter are proposed to enable simple and easy installation of the NORMA products.



NORMAEXTRA

KITS

NORMACLAMP® Quick Lock Band-on-roll



NORMACLAMP® QUICK LOCK BAND-ON-ROLL					
Width in mm	Designation	Length in m	Number of closures	W2 Product No.	W4 Product No.
9	BAND-ON-ROLL 3M	3	8	0815 7121 001	0815 7131 001
	BAND-ON-ROLL 5M	5	8	0815 7121 003	0815 7131 003
12	BAND-ON-ROLL 3M	3	6	0815 6007 002	
	BAND-ON-ROLL 5M	5	6	0815 6007 004	

NORMA® FUEL LINE REPAIR KIT



NORMA® FUEL LINE REPAIR KIT		
Content	Quantity	Product No.
NORMAQUICK S NW 3/8"-5/16"-0° Adapter	2	0715 2000 003
NORMAQUICK S NW 5/16"-6 mm-0° Adapter	2	
NORMAQUICK S NW 5/16"-6 mm-0°	2	
NORMAQUICK S NW 5/16"-6 mm-90°	2	
NORMAQUICK S NW 9.89 mm-8 mm-0°	1	
NORMAQUICK S NW 9.89 mm-8 mm-90°	1	
NORMAQUICK S NW 3/8"-5/16"-0°	2	
NORMAQUICK S NW 3/8"-5/16"-90°	2	
Sleeve - Ø 6 mm	4	
Sleeve - Ø 8 mm	4	
Rubber hose - ID 8 mm	2	
Rubber hose - ID 10 mm	2	
ABA MINI 14/9 W4	8	
ABA MINI 16/9 W4	8	

NORMACLAMP® TORRO® Assortment type 120 pcs



NORMACLAMP® TORRO® ASSORTMENT TYPE 120 PCS					
Width in mm	Designation	Clamping range in mm	Quantity	W1 Product No.	W4 Product No.
9	TORRO 8 - 16/9	8 - 16	40	0126 5005 012	0126 5005 014
	TORRO 12 - 22/9	12 - 22	25		
	TORRO 16 - 27/9	16 - 27	20		
	TORRO 20 - 32/9	20 - 32	15		
	TORRO 25 - 40/9	25 - 40	10		
	TORRO 35 - 50/9	35 - 50	10		
NA	FLEXIDRIVER	NA	1		

TORRO® WF Assortment



TORRO® WF ASSORTMENT				
Width in mm	Designation	Clamping range in mm	Quantity	W3 Product No.
9	TORRO® WF 12 - 22/9	12 - 22	5	0137 9702 050
	TORRO® WF 20 - 32/9	20 - 32	10	
	TORRO® WF 30 - 45/9	30 - 45	10	
12	TORRO® WF 40 - 60/12	40 - 60	10	
	TORRO® WF 50 - 70/12	50 - 70	10	
	TORRO® WF 60 - 80/12	60 - 80	5	

NORMACLAMP® COBRA Kit type 500 pcs



This workshop range is a clearly arranged collection of the most commonly used types of NORMACLAMP® COBRA hose clips in a practical plastic case (approx. 34 x 23 x 5 cm).

A workshop range comprises of 500 NORMACLAMP® COBRA hose clips made from stainless steel nickel chromium steel and with band widths of 7 mm and 8 mm as follows:

NORMACLAMP® COBRA KIT TYPE 500 pcs				
Width in mm	Designation	Diameter in mm	Quantity	W4 Product No.
7	COBRA 7.5/7	7.5	30	0773 9000 500
	COBRA 8/7	8	25	
	COBRA 8.5/7	8.5	25	
	COBRA 9/7	9	25	
	COBRA 9.5/7	9.5	25	
	COBRA 10/7	10	25	
	COBRA 10.5/7	10.5	25	
	COBRA 11/7	11	25	
COBRA 11.5/7	11.5	25		
8	COBRA 12/8	12	30	
	COBRA 13/8	13	30	
	COBRA 14/8	14	30	
	COBRA 15/8	15	30	
	COBRA 16/8	16	30	
	COBRA 17/8	17	30	
	COBRA 18/8	18	30	
	COBRA 19/8	19	30	
	COBRA 20/8	20	30	
	COBRA 21/8	21	30	

NORMACLAMP® FBS Assortment



NORMACLAMP® FBS ASSORTMENT		
Designation	Quantity	PA 6 Product No.
FBS 14/12 SW	10	0112 7024 001
FBS 16/12 SW	10	
FBS 17/12 SW	10	
FBS 19/12 SW	10	
FBS 23/12 SW	10	
FBS 27/12 SW	5	
FBS 29/12 SW	5	
FBS 32/12 SW	5	
FBS 40/12 SW	5	
FBS 44/12 SW	5	

NORMAQUICK® PLAST® Assortment



NORMAquick® PLAST® ASSORTMENT		
Designation	Quantity	PA 6 Product No.
NQS NW 8-6 0°	3	0700 2011 000
NQS NW8-6 90°	3	
NQS NW10-8-0°	3	
NQS NW10-8-90°	3	
NQS NW1/4"-1/4"-0°	3	
NQS NW1/4"-1/4"-90°	3	
NQS NW5/16"-06-0°	3	
NQS NW5/16"-06-90°	3	
ADAPTER NQS 5/16"-6-0°	3	
NQS NW3/8"5/16-0°	3	
NQS NW3/8"-5/16-90°	3	
ADAPTER NQSNW3/8"-5/16"-0°	3	
GS 6	5	
TS 6	5	
GS 8	5	
TS 8	5	
GS 10	5	
TS 10	5	

NORMAPLAST® Assortment type 365 PA 6 and TORRO® W2



NORMAPLAST® ASSORTMENT TYPE 365 PA 6 and TORRO® W2				
Width in mm	Designation	Diameter in mm	Quantity	PA 6 W2 (TORRO®) Product No.
NA	GS 4	4	50	0773 9000 365
	TS 4	4	50	
	YS 4	4	50	
	GS 6	6	25	
	TS 6	6	25	
	YS 6	6	25	
	GS 8	8	20	
	TS 8	8	10	
	YS 8	8	10	
	GRS 8 - 6	8	20	
7.5	TORRO 8 - 12/7.5	8 - 12	40	
	TORRO 10 - 16/7.5	10 - 16	40	

NORMACLAMP® TORRO® Dispenser



NORMACLAMP® TORRO® DISPENSER				
Width in mm	Designation	Clamping range in mm	Quantity	W2 Product No.
7.5	TORRO 8 - 12/7.5	8 - 12	10	0126 9702 010
9	TORRO 8 - 16/9	8 - 16	10	
	TORRO 12 - 22/9	12 - 22	10	
	TORRO 16 - 27/9	16 - 27	10	
	TORRO 20 - 32/9	20 - 32	10	
	TORRO 25 - 40/9	25 - 40	10	
	TORRO 32 - 50/9	32 - 50	10	
	TORRO 40 - 60/9	40 - 60	10	
	TORRO 50 - 70/9	50 - 70	10	
TORRO 60 - 80/9	60 - 80	10		

NORMACLAMP® TORRO® Pallet



NORMACLAMP® TORRO® PALLET					
Width in mm	Designation	Clamping range in mm	Quantity	W1 Product No.	W4 Product No.
9	TORRO 8 - 16/9	8 - 16	40	0126 5006 012	0126 5006 015
	TORRO 12 - 22/9	12 - 22	25		
	TORRO 16 - 27/9	16 - 27	20		
	TORRO 20 - 32/9	20 - 32	15		
	TORRO 25 - 40/9	25 - 40	10		
	TORRO 35 - 50/9	35 - 50	10		
NA	FLEXIDRIVER	NA	1		

NORMACLAMP® Quick Lock Band-on-roll dispenser



NORMACLAMP® QUICK LOCK BAND-ON-ROLL DISPENSER				
Width in mm	Designation	Length in m	W2 Product No.	W4 Product No.
9	BAND-ON-ROLL 3M	3	0815 5007 015	0815 5007 014
	BAND-ON-ROLL 5M	5	0815 5007 017	0815 5007 016

NORMAEXTRA

NORMACLAMP® TORRO® Assembly fixture



NORMACLAMP® TORRO® ASSEMBLY FIXTURE	
Designation	Product No.
TORRO ASSEMBLY FIXTURE	0126 9900 001

NORMACLAMP® COBRA Pneumatic pliers



These pneumatically assisted pliers are the ideal installation tool for industrial applications, allowing serial installation work involving large quantities to be handled with ease.

NORMACLAMP® COBRA PNEUMATIC PLIERS	
Designation	Product No.
COBRA PNEUMATIC PLIERS	0110 8420 010

NORMACLAMP® FBS Pneumatic pliers

1



1 Version S

Suitable for “vertical” assembly operations where the clamp head is approached from above. Ideal for high volume series assembly.

2 Version W

Suitable for “horizontal” assembly operations where the clamp head is approached from the side. For high volume series assembly.

2



NORMACLAMP® FBS PNEUMATIC PLIERS TYPE S	
Designation	Product No.
FBS PNEUMATIC PLIERS TYPE S	0115 0000 911*1
FBS PNEUMATIC PLIERS TYPE S	0115 0000 912*2

NORMACLAMP® FBS PNEUMATIC PLIERS TYPE W	
Designation	Product No.
FBS PNEUMATIC PLIERS TYPE W	0115 0000 919*1
FBS PNEUMATIC PLIERS TYPE W	0115 0000 920*2

*1 jaws are opened before release
*2 jaws are closed before release

NORMACLAMP® FBS C Multi-release tool



For unlocking pre-opened FBS C, only our release tool is permitted.

NORMACLAMP® FBS C MULTI-RELEASE TOOL	
Designation	Product No.
FBS C MULTI-RELEASE TOOL	0115 0000 936

NORMAFIX® Cable tie pliers



2.2 to 4.8 mm



4.8 to 7.8 mm



3.6 mm to 13 mm



4.7 mm to 13 mm



3.8 mm to 13 mm



4.7 mm to 13 mm

1	NORMAFIX® CABLE TIE PLIERS FROM 2.2 TO 4.8 MM
Designation	Product No.
PLIERS FOR NYLON CABLE TIE FROM 2.2 TO 4.8 MM - SEMI-AUTOMATIC	0860 1000 001
2	NORMAFIX® CABLE TIE PLIERS FROM 4.8 TO 7.8 MM
Designation	Product No.
PLIERS FOR NYLON CABLE TIE FROM 4.8 TO 7.8 MM - SEMI-AUTOMATIC	0860 1000 004
3	NORMAFIX® CABLE TIE PLIERS FROM 3.6 TO 13 MM
Designation	Product No.
PLIERS FOR NYLON CABLE TIE FROM 3.6 TO 13 MM - MANUAL	0860 1000 005
4	NORMAFIX® CABLE TIE PLIERS FROM 4.7 TO 13 MM
Designation	Product No.
PLIERS FOR NYLON CABLE TIE FROM 4.7 TO 13 MM - MANUAL	0892 0000 003
5	NORMAFIX® PLIERS FOR STAINLESS STEEL BALL LOCKING CABLE TIES FROM 3.8 TO 9 MM
Designation	Product No.
PLIERS FOR STAINLESS STEEL BALL LOCKING CABLE TIES FROM 3.8 TO 9 MM - SEMI-AUTOMATIC	0892 0000 001
6	NORMAFIX® PLIERS FOR STAINLESS STEEL BALL LOCKING CABLE TIES FROM 3.8 TO 9 MM
Designation	Product No.
PLIERS FOR STAINLESS STEEL BALL LOCKING CABLE TIES FROM 3.8 TO 9 MM - MANUAL	0892 0000 002

NORMAFIX® NORMETTA® Clamping and cutting tool



This high quality cast tool is recommended for professional work. Easy to use, it provides a tensile force of approximately 10,000 N (1000 KP).

NORMAFIX® NORMETTA® CLAMPING AND CUTTING TOOL	
Designation	Product No.
CLAMPING AND CUTTING TOOL	0560 8555 001

NORMACLAMP® Ear clip pliers



NORMACLAMP® EARCLIP PLIERS	
Designation	Product No.
EAR CLIP PLIERS END CLOSING	0819 0022 094
EAR CLIP PLIERS SIDE CLOSING	0819 0022 095

NORMACLAMP® COBRA Handheld pliers



CHT1



CHT2

These handheld pliers enable precise installation and removal. The tips of the pliers' head enable a secure grip on the clip's tool gripping points. The integrated smooth-running spring element keeps the pliers open continuously, allowing you to work quickly and comfortably.

CHT 1 allows a connect and disconnect function.
CHT 2 only allows a connection function.

NORMACLAMP® COBRA CHT 1	
Designation	Product No.
COBRA CHT 1	0110 8420 000

NORMACLAMP® COBRA CHT 2	
Designation	Product No.
COBRA CHT 2	0110 8420 004

PLIERS

NORMACLAMP® FBS Handheld pliers

1



2



For professional installation of FBS standard clamps, two types of handheld pliers are available depending on the nominal diameter involved:

- 1 Type 1: for small nominal diameters (up to 40 mm).
- 2 Type 2: for all diameters, with integrated safety lever for fixing the pliers in position.

NORMACLAMP® FBS PLIERS	
Designation	Product No.
FBS PLIERS	0115 0000 903

NORMACLAMP® FBS PLIERS WITH INTEGRATED SAFETY LEVER	
Designation	Product No.
FBS PLIERS WITH INTEGRATED SAFETY LEVER	0115 0000 904

Pliers for the FBS R are available on request

NORMAFIX® RSGUV 1 / RSV 1 Handheld pliers



For professional installation of RSGUV 1 / RSV 1 clips, two types of handheld pliers are available depending on the band width involved.

NORMAFIX® RSGUV 1 / RSV 1 PLIERS	
Designation	Product No.
RSGUV 1 / RSV 1 PLIERS 15	0981 0000 151
RSGUV 1 / RSV 1 PLIERS 20	0981 0000 201

NORMACLAMP® TORRO® Screwdriver SW6, SW7, SW6/7



NORMACLAMP® TORRO® SCREWDRIVER SW6, SW7, SW6/7	
Designation	Product No.
SW6	0000 0000 899
SW7	0000 0000 898
SW6/7	0000 0000 894

NORMACLAMP® Tamperproof Screwdriver



NORMACLAMP® TAMPERPROOF SCREWDRIVER	
Designation	Product No.
TAMPERPROOF SCREWDRIVER	0126 9900 003

NORMACLAMP® Hi-torque T-screwdriver



NORMACLAMP® HI-TORQUE T-SCREWDRIVER	
Designation	Product No.
T-SCREWDRIVER FOR HI-TORQUE CLAMP	0560 6600 001

NORMAFIX® Tube clamp fittings Hexagonal key



NORMAFIX® HEXAGONAL KEY		
Designation	Diameter in mm	Product No.
HEXAGONAL KEY 26.9/33.7	26.9/33.7	0819 6332 001
HEXAGONAL KEY 42.4/48.3/60.3	42.4/48.3/60.3	0819 6332 002

NORMAEXTRA

NORMAFIX® Tube clamp fittings Plastic end cap



NORMAFIX® PLASTIC END CAP		
Designation	Diameter in mm	Product No.
PLASTIC END CAP 33.7	33.7	0819 6330 034
PLASTIC END CAP 42.4	42.4	0819 6330 042
PLASTIC END CAP 48.3	48.3	0819 6330 048

NORMAFIX® Tube clamp fittings Spare screws



NORMAFIX® SPARE SCREW		
Designation	Diameter in mm	Product No.
SPARE SCREW 26.9/33.7	26.9/33.7	0819 6331 001
SPARE SCREW 42.4/48.3/60.3	42.4/48.3/60.3	0819 6331 002

NORMAFIX® Lamppost protection tape



NORMAFIX® LAMPOST PROTECTION TAPE		
Designation	Length in m	PVC Product No.
BLACK EPDM PROTECTION TAPE ROLL OF 10 METERS	10	0560 7640 010
WRAP & SEAL VULCANIZING STRETCHABLE TAPE TAPE - BLACK 2.4 METERS	2.4	0560 7640 002
WRAP & SEAL VULCANIZING STRETCHABLE TAPE TAPE - BLACK 4.8 METERS	4.8	0560 7640 004

NORMAFIX® Cable tie Wall plug bases for cable tie

For fixing cables and pipes to walls. Very easy installation for cable ties up to 9 mm width.



NORMAFIX® WALL PLUG BASES FOR CABLE TIES			
Designation	PA 6.6		
	White	Black	Grey
	Product No.	Product No.	Product No.
WALL PLUG BASES FOR CABLE TIES WITHOUT FINS 8 MM BASE	0860 0701 002	0860 0701 001	
WALL PLUG BASES FOR CABLE TIES WITH FINS 6 MM BASE	0860 0701 112	0860 0701 111	0860 0703 111
WALL PLUG BASES FOR CABLE TIES WITH FINS 8 MM BASE	0860 0701 102	0860 0701 101	0860 0703 101

NORMAFIX® Cable tie Mounting bases for cable tie

For fixing cables and pipes to walls. Very easy installation for cable ties up to 9 mm width.



NORMAFIX® MOUNTING BASES FOR CABLE TIES WITHOUT ADHESIVE									
Number of entrances	Designation	For cable ties band width in mm	Dimensions (mm)					PA 6.6	
			A	B	C	F	H	White	Black
			Product No.	Product No.					
1	MOUNTING BASES FOR CABLE TIES WITHOUT ADHESIVE 3.6	3.6	19	19	4.2	4	5	0860 0811 001	0860 0812 001
	MOUNTING BASES FOR CABLE TIES WITHOUT ADHESIVE 4.8	4.8	27	27	4.2	6	7.4	0860 0811 002	0860 0812 002
2	MOUNTING BASES FOR CABLE TIES WITHOUT ADHESIVE 3.6	3.6	19	19	4.1	4	5	0860 0911 001	0860 0912 001
	MOUNTING BASES FOR CABLE TIES WITHOUT ADHESIVE 4.8	4.8	27	27	4.8	6	6.5	0860 0911 002	0860 0912 002

NORMAFIX® MOUNTING BASES FOR CABLE TIES WITH ADHESIVE									
Number of entrances	Designation	For cable ties band width in mm	Dimensions (mm)					PA 6.6	
			A	B	C	F	H	White	Black
			Product No.	Product No.					
1	MOUNTING BASES FOR CABLE TIES WITH ADHESIVE 3.6	3.6	19	19	4.2	4	5	0860 0831 001	0860 0832 001
	MOUNTING BASES FOR CABLE TIES WITH ADHESIVE 4.8	4.8	27	27	4.2	6	7.4	0860 0831 002	0860 0832 002
2	MOUNTING BASES FOR CABLE TIES WITH ADHESIVE 3.6	3.6	19	19	4.1	4	5	0860 0931 001	0860 0932 001
	MOUNTING BASES FOR CABLE TIES WITH ADHESIVE 4.8	4.8	27	27	4.8	6	6.5	0860 0931 002	0860 0932 002

NORMAEXTRA

NOTES

A series of horizontal dotted lines for writing notes.

A series of horizontal dotted lines for writing.

A CONNECTION THAT LASTS



NORMA® Product Catalogue

Discover our complete portfolio

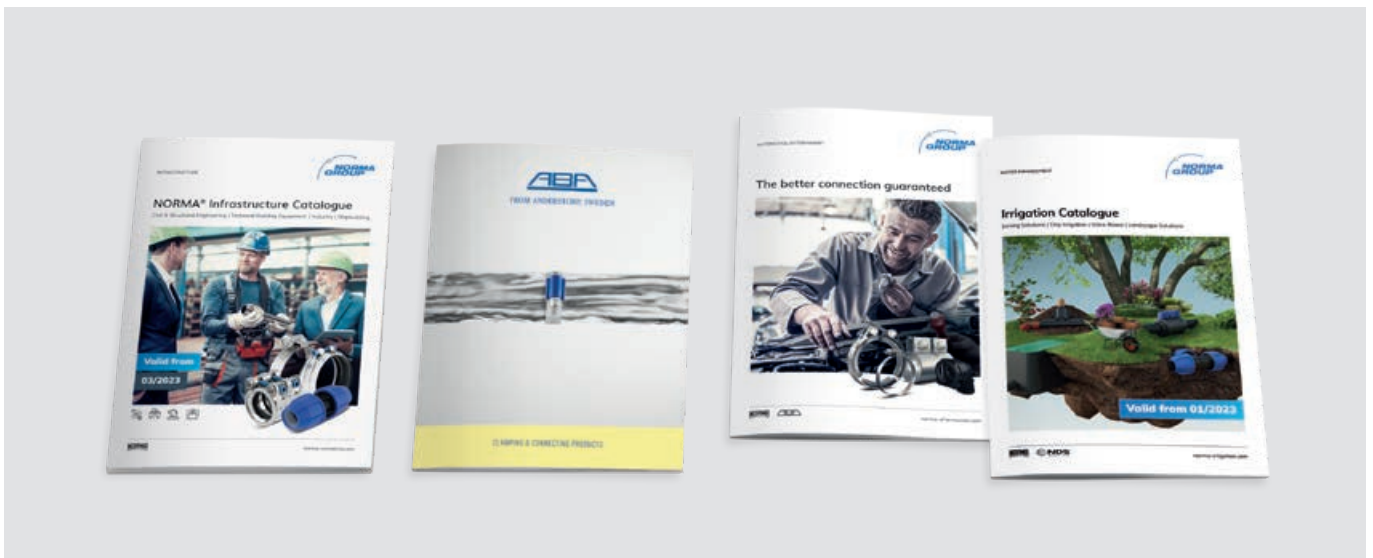

Want to have a look? Simply scan the QR code to download the catalogue.



Infrastructure catalogue

qrco.de/infra-catalogue-en



ABA catalogue

qrco.de/ABA-en



Automotive Aftermarket brochure

qrco.de/AUTO-en

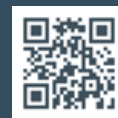

Irrigation catalogue

qrco.de/IR-en



NORMA Group Holding GmbH

Edisonstraße 4
63477 Maintal | Germany

+49 6181-403-0
norma-connects@normagroup.com

Your local distributor:

NORMA Group Holding GmbH | Edisonstraße 4 | 63477 Maintal | Germany | normagroup.com

This document supersedes all previous issues. No part of this publication may be reproduced without our prior written consent. In NORMA Group's policy of continual product improvements to meet user needs and technological developments, all models and sets listed in this folder (photographs, specifications, sizes and weights) may be upgraded or discontinued without notice and without any obligation on our part to modify tools or equipment sold previously. The recommendations for use and safety given in this folder do not replace accepted good practice or the safety related legal and regulatory provisions. References to standards implemented as of February 27, 2023 are not contractually binding.